

the tectonics of the
double skin:

understanding double
façade systems



Occidental Chemical, Niagara Falls

The nature of the presentation:

- the purpose of this presentation is to provide an overview of double skin façade systems
- to compare the different types of systems
- how they function (differently than common curtain wall)
- to look at various building applications
- the presentation will NOT address issues of cost and ultimate performance in any detail as this information is not available



Double skin building façades are being used on a number of vanguard buildings that are being held forward as examples of sustainable or green building design. What are these buildings and how do they work? **Are they really green???**



Debis Tower



Helicon, Finsbury Pavement



Tjibaou Cultural Center

How is it different from a curtain wall?

The double skin façade system is essentially a **pair of glass skins** separated by an air corridor.

The **main layer** of glass is *usually* insulating and is very similar to a standard curtain wall.

There is an **extra layer** of glass that is added to the system.

The **air space** between the two layers acts as an insulating barrier against temperature extremes, noise, and wind.

Sun **shading devices** are often located between the two skins.

Recommended reading and image sourcing:

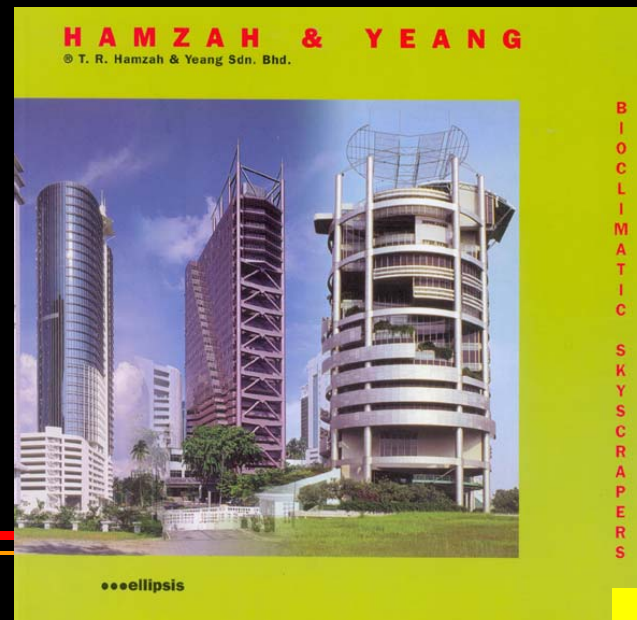
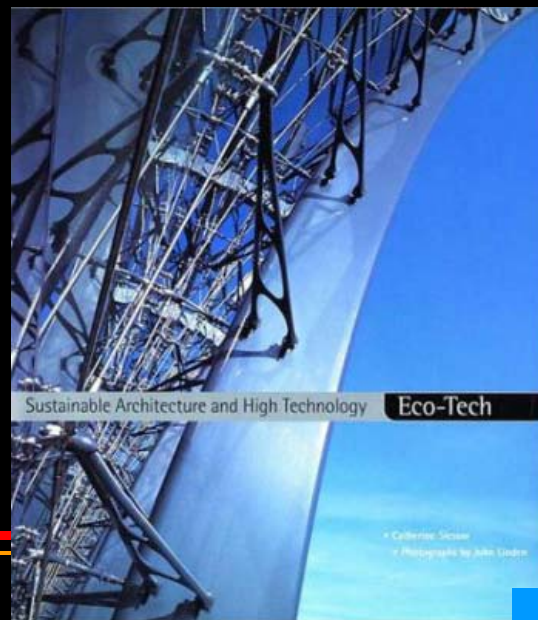
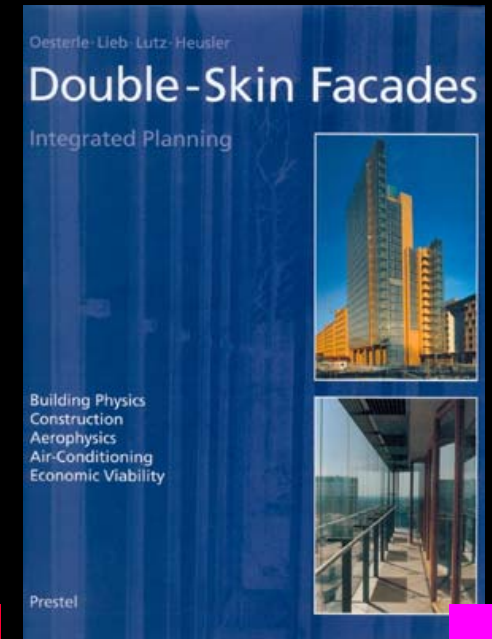
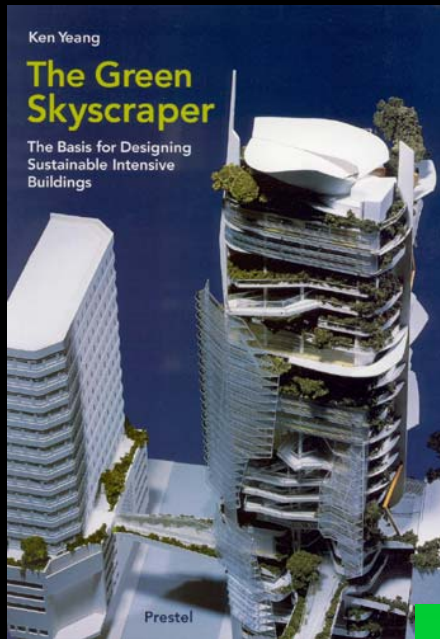

The coloured squares will be used throughout the powerpoint to provide text references.

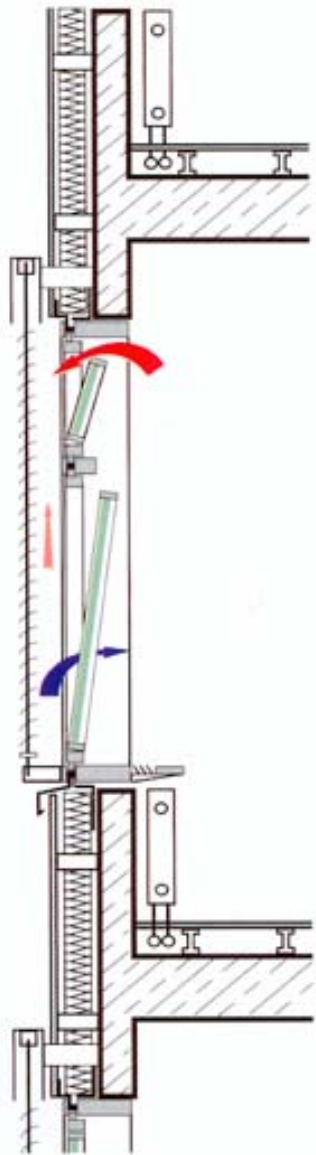

1.1 Comparison of single-skin and double-skin facade construction.

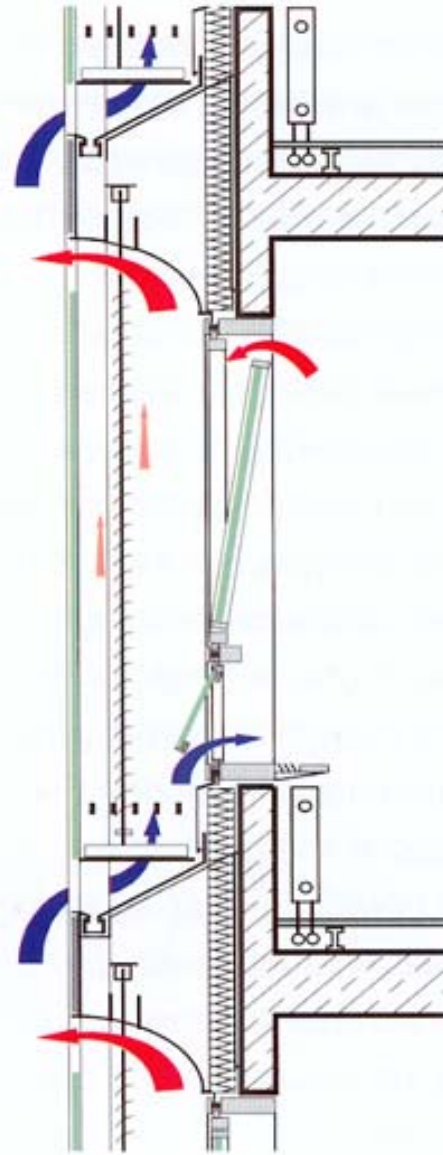

Double skin
façade
construction is
based upon a
multi-layer
principle.

Early History:

Paimio Tuberculosis Sanitarium, Alvar Aalto, 1929-1933

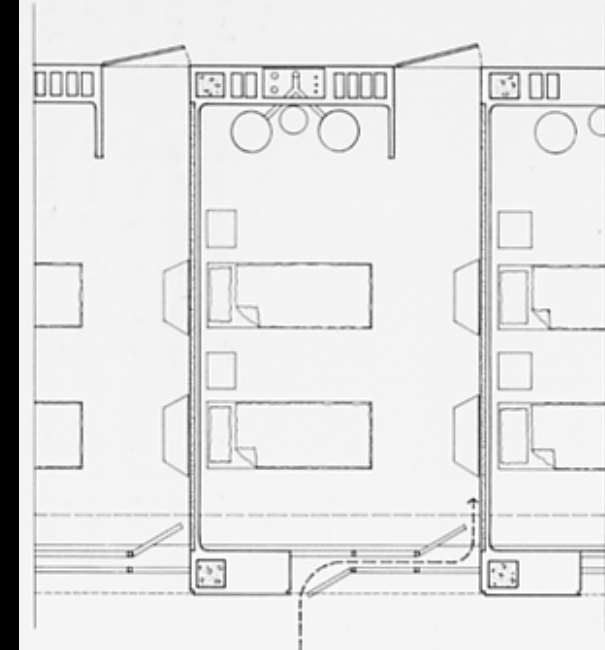
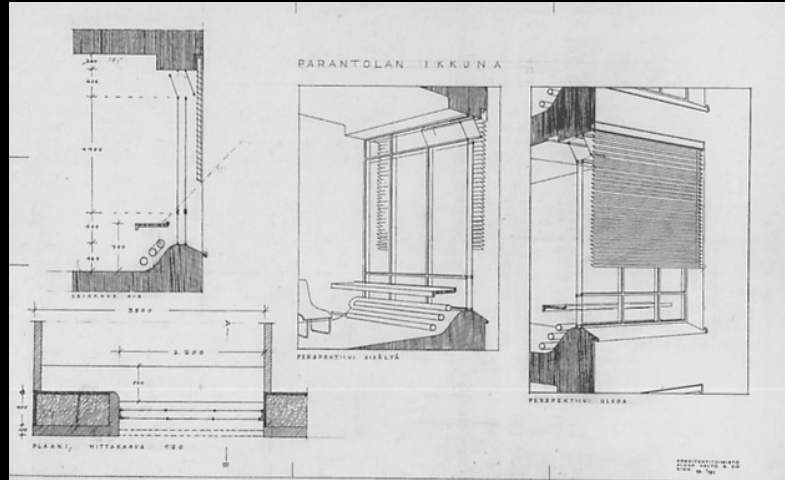

The early double façade configuration of the triple-mullioned windows in the patients' wing exemplified Aalto's concern for the human aspect and patients' needs. This early double skin technology was a subtle improvement on the conventional European double skin system prevalent at the time, but it was Aalto's overall humanistic design philosophy, which placed the user at its center, that elevated this sanitarium above its overall functionalist design.

Le Corbusier: Le Mur Neutralisant 1933 - 1947

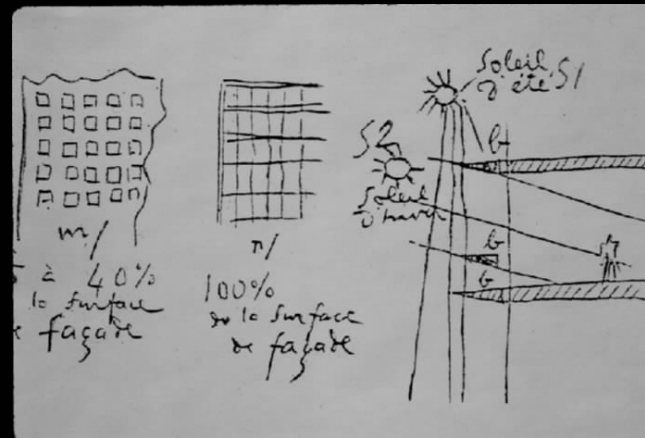
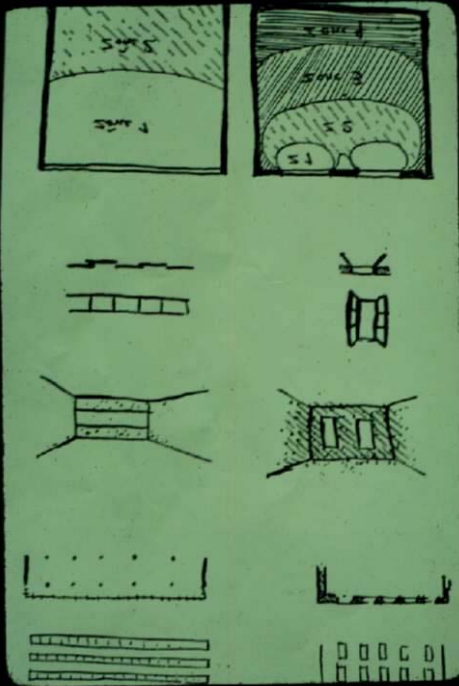

Le Corbusier's Mur Neutralisant was an early experiment with a type of double skin façade system. It proposed the use of blowers to circulate heated air between two layers of glazing. It was not constructed as proposed, instead installed as sealed glazing that failed miserably. The entire façade was redesigned with operable windows. These images of the Cite de Refuge show the current façade condition.



Basic Types:

There are 4 basic types of double skin systems:

- Buffer Façade
- Extract-Air Façade
- Twin-Face Façade
- Hybrid Façade

(As defined by Architectural Record Con-ed article by Lang and Herzog. Different/more complex definitions by Battle McCarthy.)



RWE Building, Germany

Buffer Façade:

- dates back some 100 years
- predates insulating glass and were invented to maintain daylight into buildings while increasing insulating and sound properties of the wall system
- use two layers of single glazing spaced 250 to 900 mm apart, sealed and allowing fresh air into the building through additional controlled means – either a separate HVAC system or box type windows which cut through the overall double skin
- shading devices can be included in the cavity
- modern example of this type is the Occidental Chemical/Hooker Building in Niagara Falls, New York

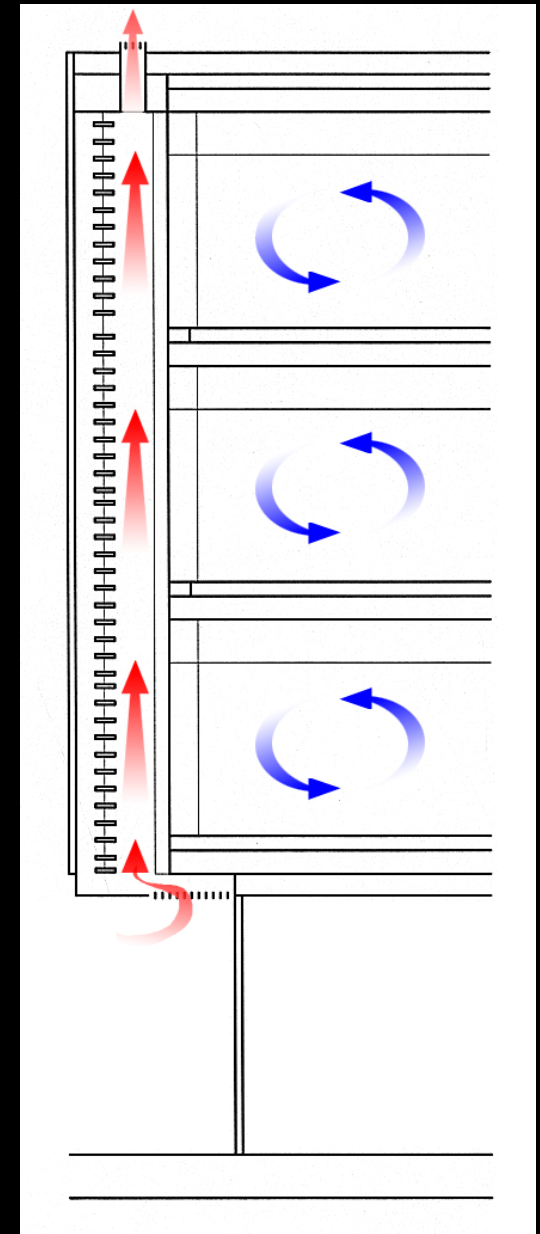

Extract-Air Façade:

- comprised of a second single layer of glazing placed on the interior of a main façade of double-glazing (thermopane units)
- the air space between the two layers of glazing becomes part of the HVAC system. The heated "used" air between the glazing layers is extracted through the cavity with the use of fans and thereby tempers the inner layer of glazing while the outer layer of insulating glass minimizes heat-transmission loss.
- fresh air is supplied by HVAC and precludes natural ventilation.

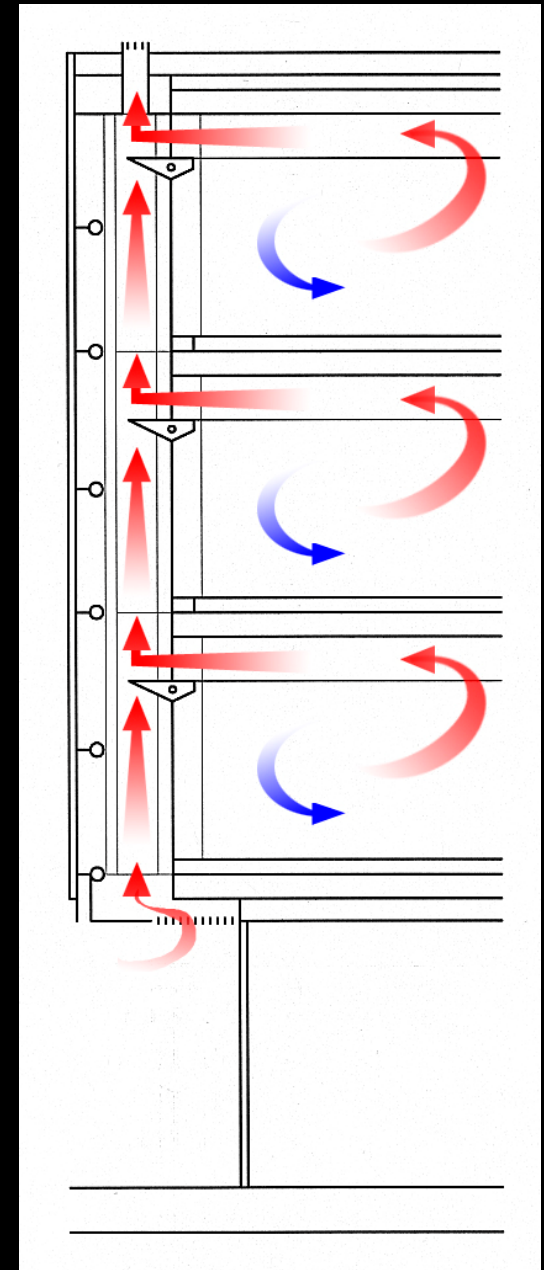

Extract-Air Façade cont'd:

- the air contained within the system is used by the HVAC system
- these systems tend not to reduce energy requirements as fresh air changes must be supplied mechanically
- occupants are prevented from adjusting the temperature of their individual spaces
- shading devices are often mounted in the cavity. Again the space between the layers of glass ranges from around 150 mm to 900 mm and is a function of the space needed to access the cavity for cleaning as well as the dimension of the shading devices
- this system is used where natural ventilation is not possible (for example in locations with high noise, wind or fumes).



Helicon Building, Finsbury Pavement, London

Twin-Face Façade:

- consists of a conventional curtain wall or thermal mass wall system inside a single glazed building skin
- outer glazing may be safety or laminated glass or insulating glass
- shading devices may be included
- normally have an interior space of at least 500 to 600 mm to permit cleaning
- distinguished from both Buffer and Extract Air systems by their inclusion of openings in the skin to allow for natural ventilation
- single-glazed outer skin is used primarily for protection of the air cavity contents (shading devices) from weather
- the internal skin offers the insulating properties to minimize heat loss.

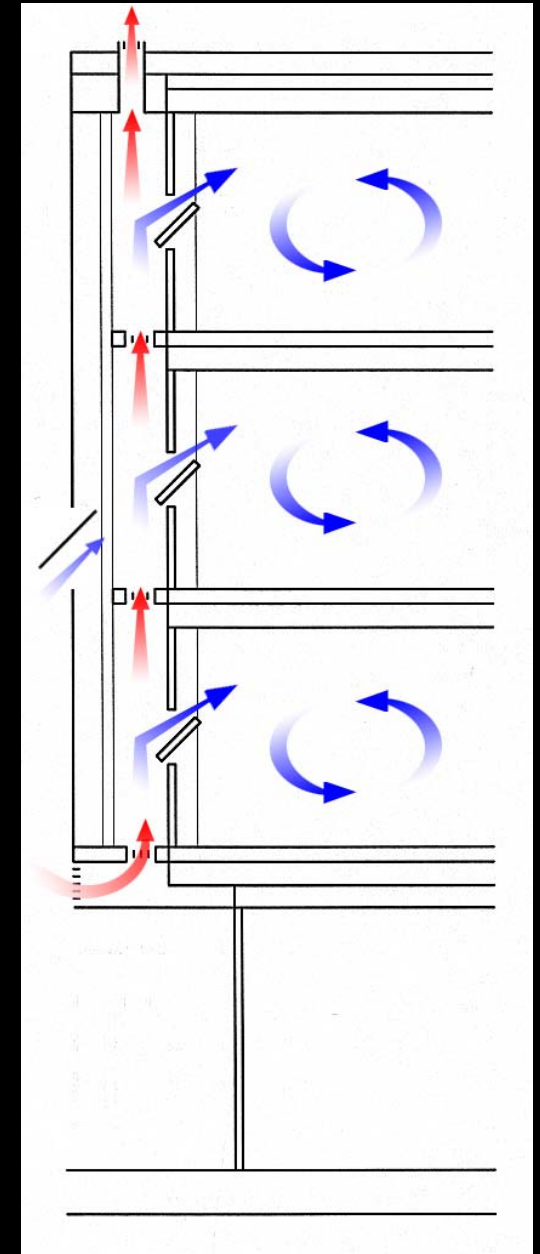

Twin Face Façade cont'd:

- outer glass skin is used to block/slow the wind in high-rise situations and allow interior openings and access to fresh air without the associated noise or turbulence
- Windows on the interior façade can be opened, while ventilation openings in the outer skin moderate temperature extremes within the façade
- use of windows allows for night-time cooling of the interior thereby lessening cooling loads of the building's HVAC system.
- For sound control, the openings in the outer skin can be staggered or placed remotely from the windows on the interior façade
- RWE Tower in Germany would typify a classic Twin-Face building.

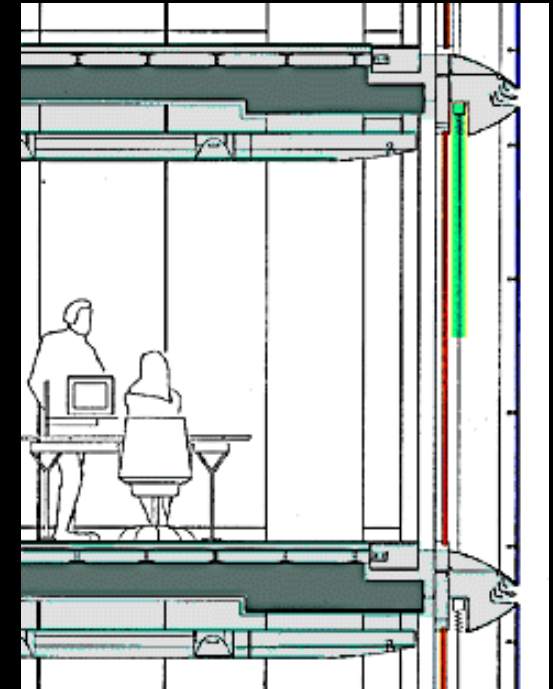

RWE section

Hybrid Façade:

The hybrid façade is a system that combines one or more of the basic characteristics of the 3 main typologies to create a new system.

Renzo Piano's Tjibaou Cultural Center in New Caledonia would be an example of this type.

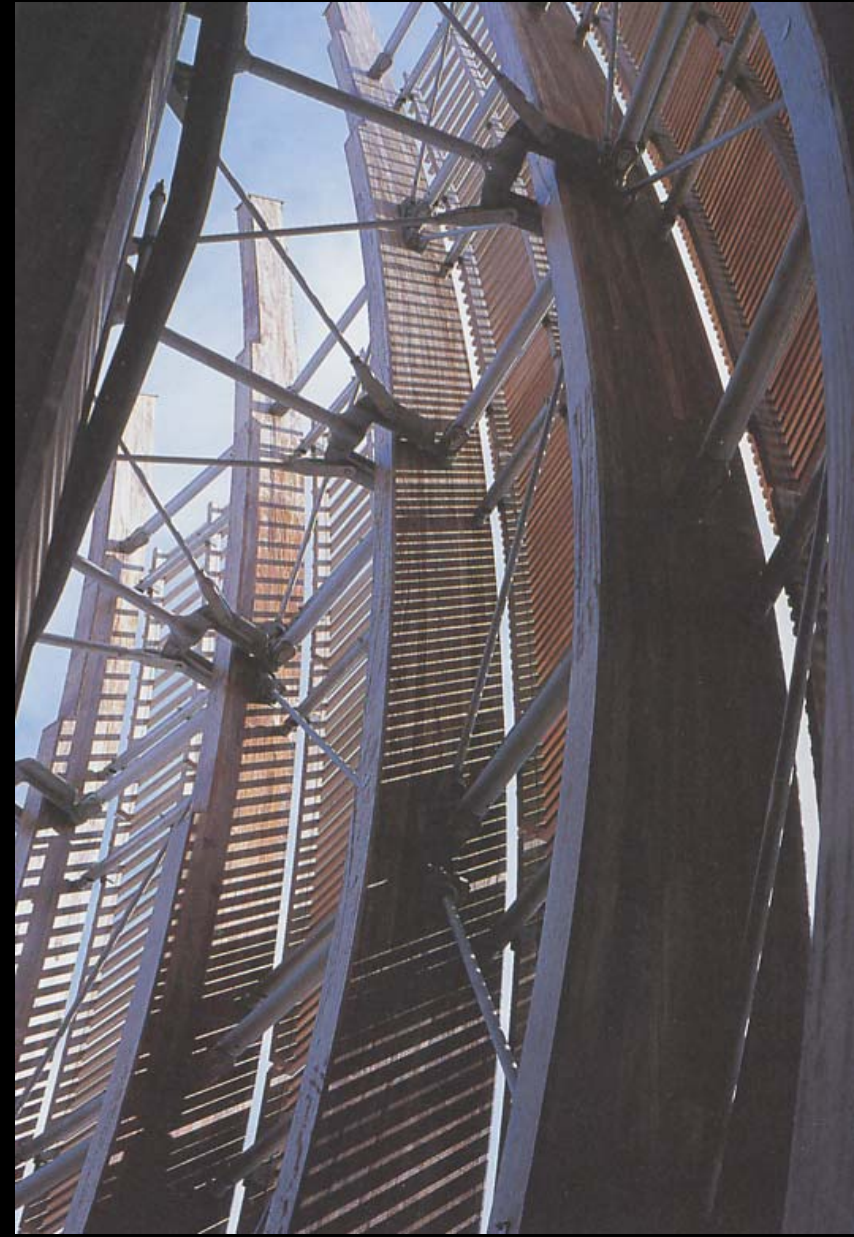
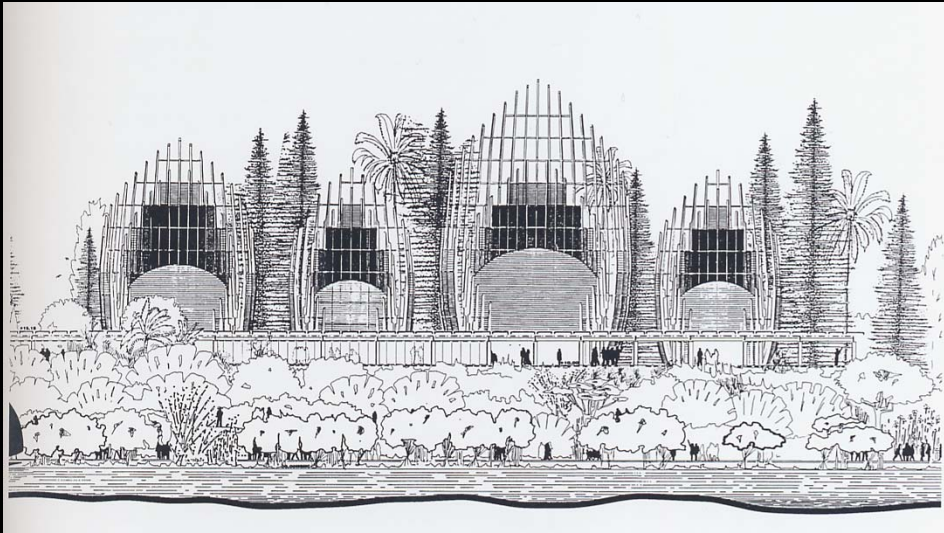

The Air Space:

Divided

- compartmentalized by floor and into bays
- best for fire protection and sound transmission
- usually narrower (less floor area)
- intake and outward venting openings in each compartment
- less use of natural physics for air movement

Undivided

- benefits from stack effect
- openings at the base let in cool air
- openings at the top can vent overheated air
- can be transformed into atria (Commerzbank) and include plants (oxygen + shading)
- usually wider (more floor area)
- can transmit noise and odors

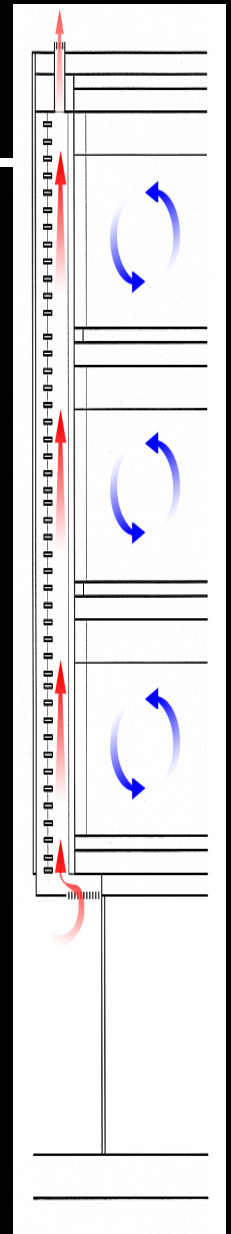

Undivided Air Space:



Occidental Chemical,
Buffer Space

- The Occidental Chemical Building (Hooker) is a classic undivided air space
- It also boasts the classic problems: intake of dirt at base that is spread to the top
- as this buffer façade does not have any operable windows, noise cannot be transmitted from office to office

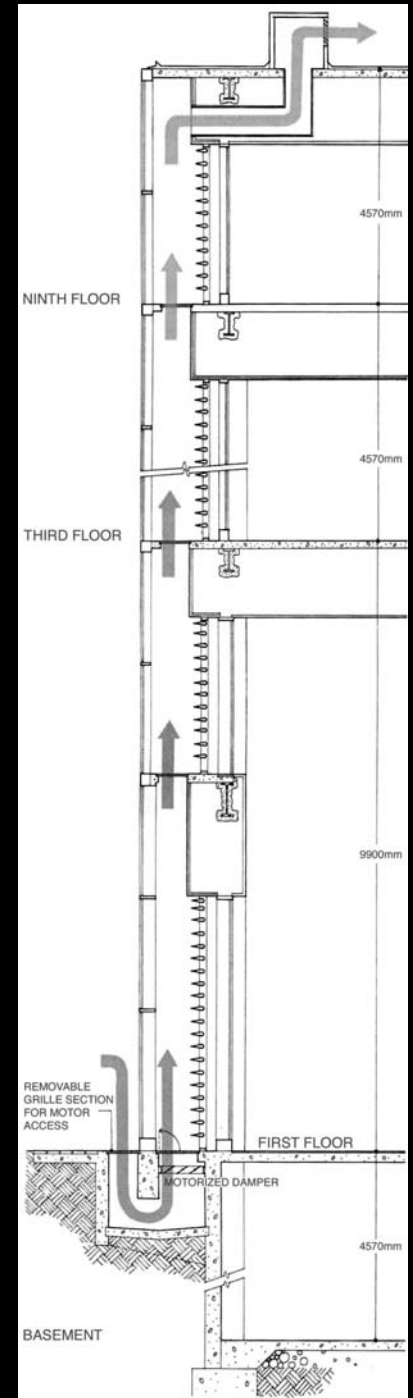

Divided Air Space:

The air space of the RWE Building is divided, both vertically and horizontally.

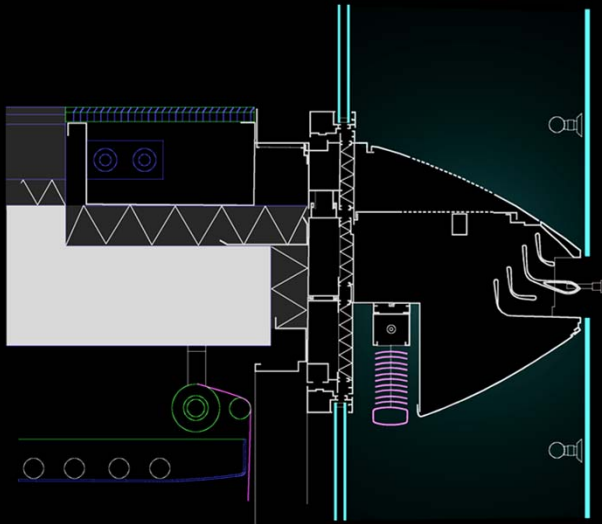

The "fish-mouth" detail

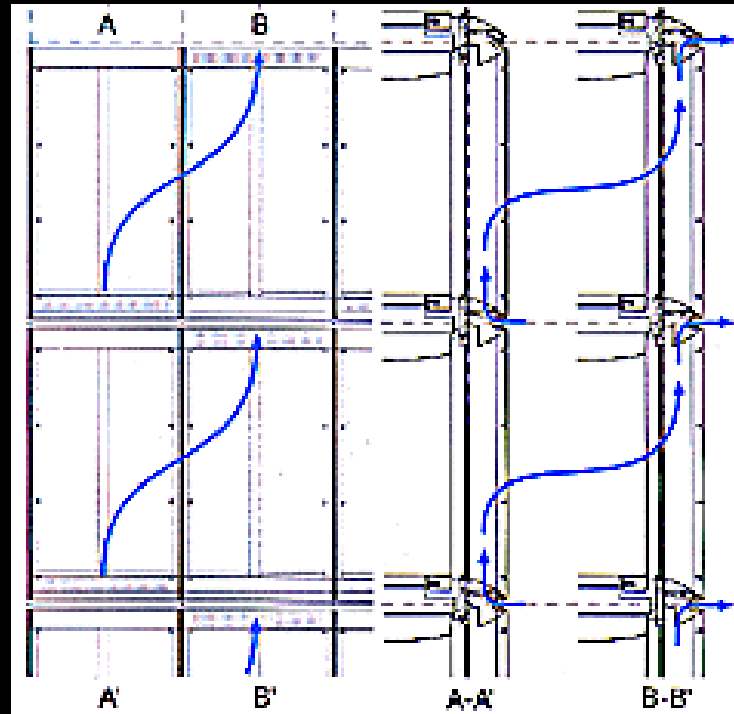

Another view...

The following images are excerpted from this text, which is an excellent (and sadly out of print) source book for detailed and scientific aspects of double façade construction.

In this perspective the author puts forward that the *“classification could be made according to the form in which the intermediate space is divided and according to the desired ventilation function.”*

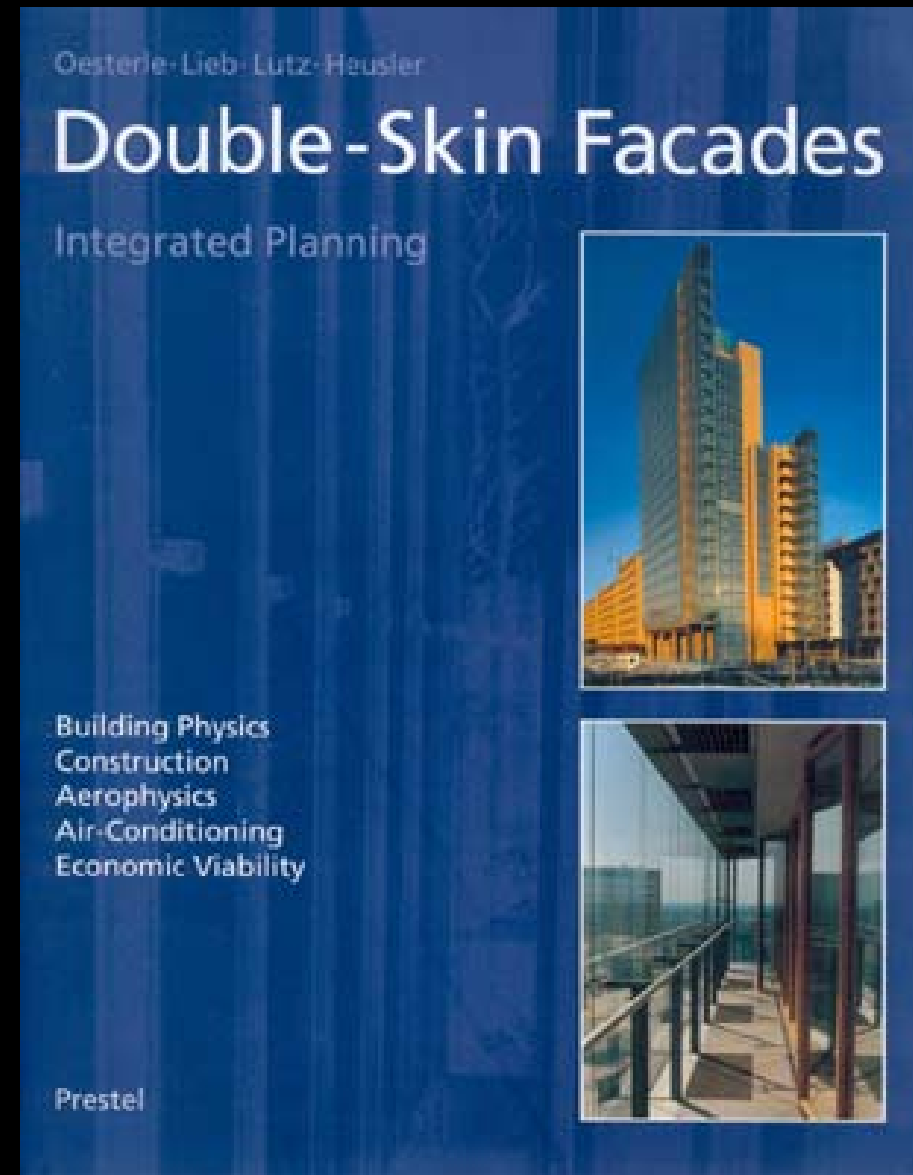

Four double façade types are proposed:

- box windows
- shaft-box façades
- corridor façades
- multi-storey façades



Helicon Building, Finsbury Pavement

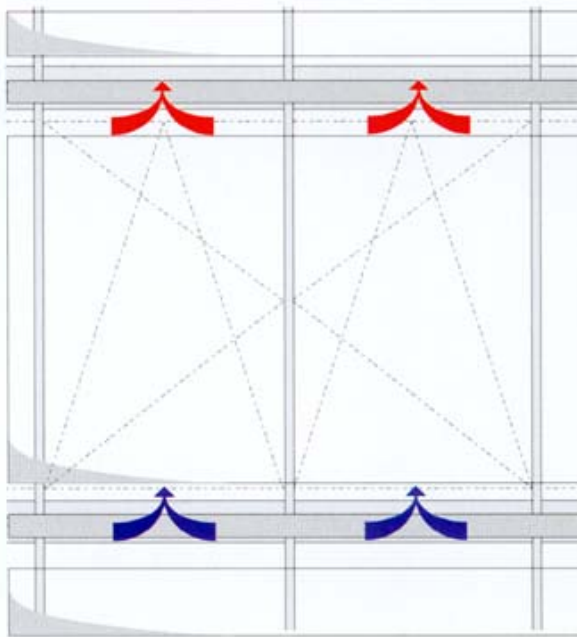

1.2 Elevation of box-window facade. The divisions between each bay mean that an opening light is also required for each bay.

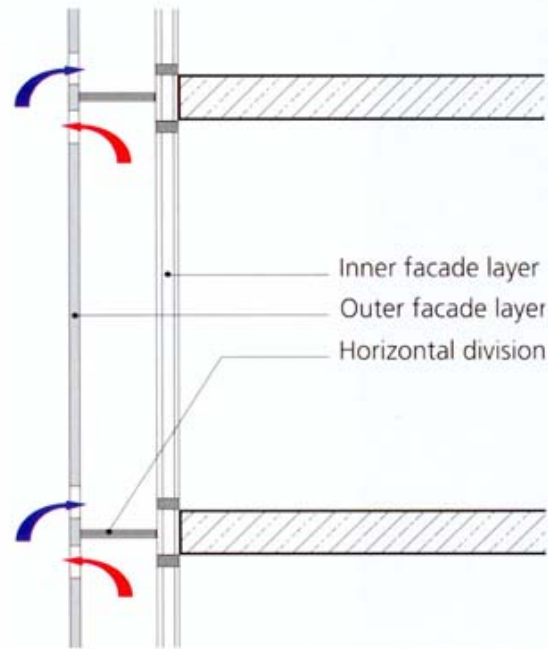

1.3 Section through typical box-window facade with separate ventilation for each bay.

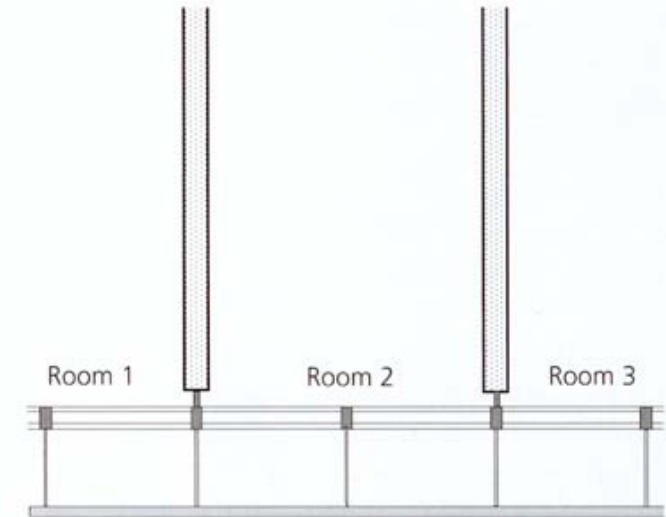

1.4 Plan of box-window facade. The divisions of the facade intermediate space are set on the construction axes.

The Box Window Type: oldest form. Consists of a frame with inward opening casements. Openings on external skin for fresh air. Cavity divided horizontally and vertically generally on a room by room basis. The divisions help to prevent passage of sound and smells from room to room. Each window requires its own air intake and extract openings.

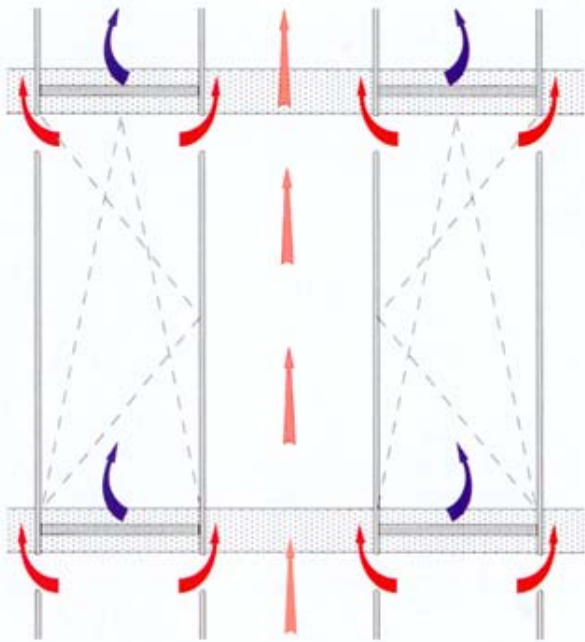

1.8 Elevation of a shaft-box facade. The arrows indicate the route of the airstream.

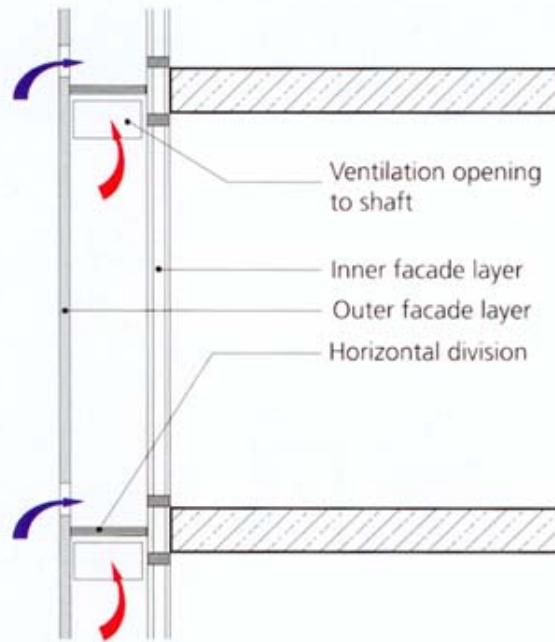

1.9 Section through a shaft-box facade. The arrows indicate the route of the airstream flowing through the box windows into the common ventilation shaft.

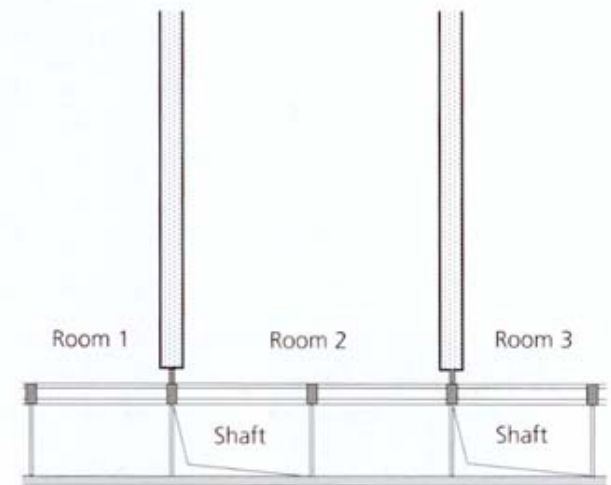

1.10 Plan of a shaft-box facade
There are side openings in the shaft divisions in the facade intermediate space.

The Shaft-box Type: special form of box window based on the twin-face concept. Consists of box windows with continuous vertical shafts that extend over several stories to create a stack effect. Façade consists of an alternation of boxes and shafts. Require fewer openings on the external skin thereby offsetting urban noise infiltration. Best suited to lower rise buildings.

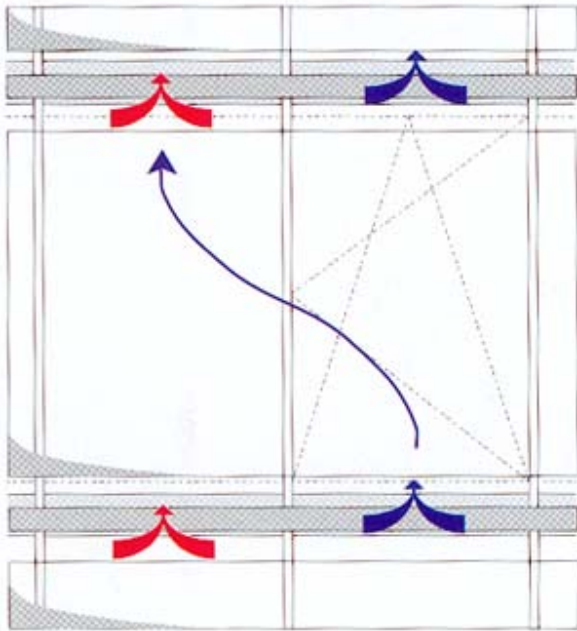

1.15 Elevation of corridor facade. Air flows on the diagonal to prevent vitiated air from the lower story being sucked in with the air supply of the floor above (recontamination).

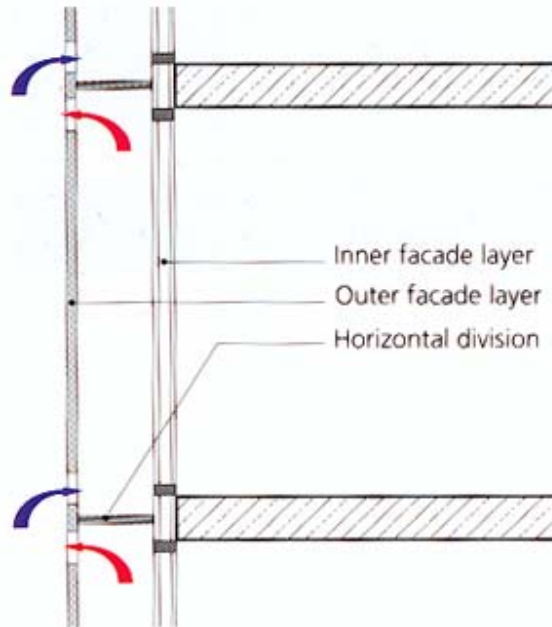

1.16 Section through a corridor facade. Separate circulation for each story.

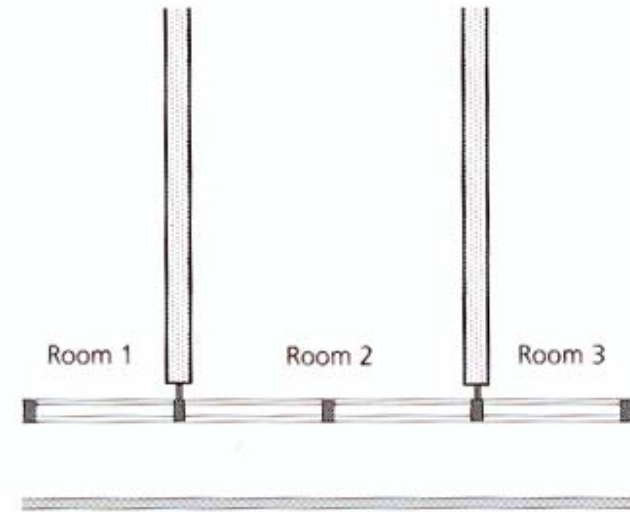

1.17 Plan of a corridor facade. The intermediate space is not divided at regular intervals along its horizontal length.

The Corridor Type: the intermediate space between the two skins is closed at the level of each floor. Divisions occur along the horizontal length of the corridor only where this is necessary for acoustic, fire-protection or ventilation reasons. This usually happens at the corners of buildings to prevent cross drafts. Air intake at floor, extract at ceiling.

Divisions in the façade are usually planned where there is a pressure difference along the façade.

9-3 Far right: qualitative pressure distribution around a high-rise building with a square plan, where the wind direction is at right angles to one side.

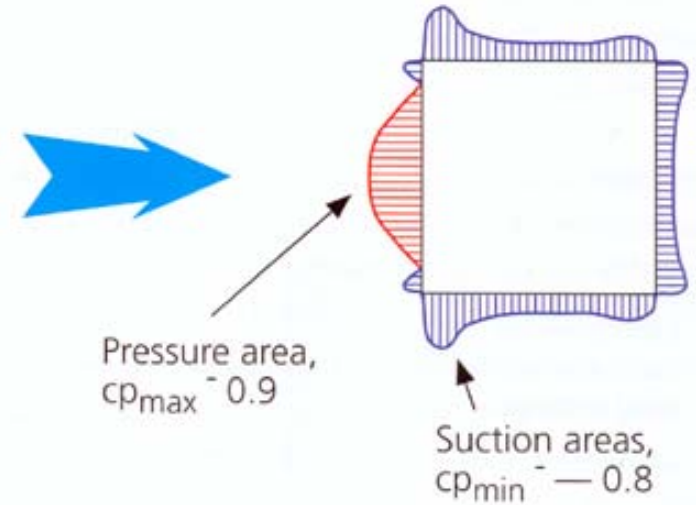

9-4 Far right: qualitative pressure distribution around a high-rise building with a square plan, where the wind direction is on the diagonal.

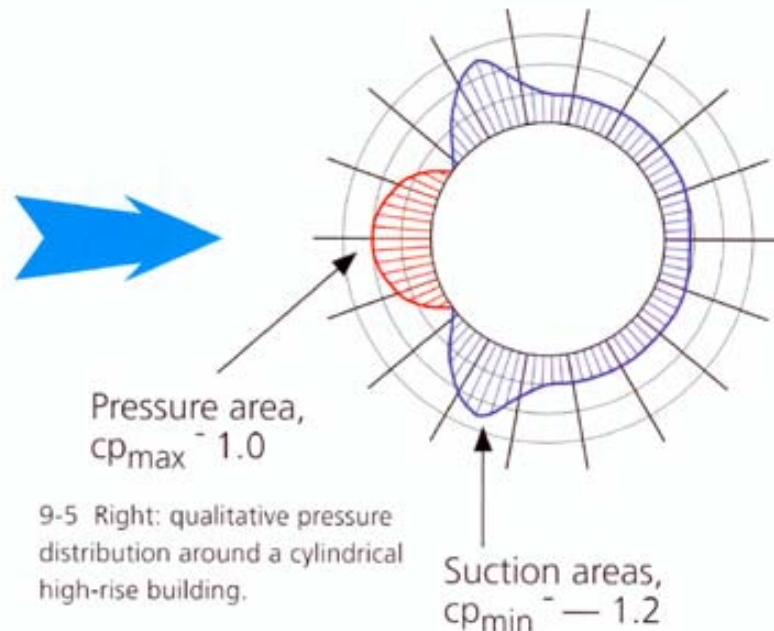
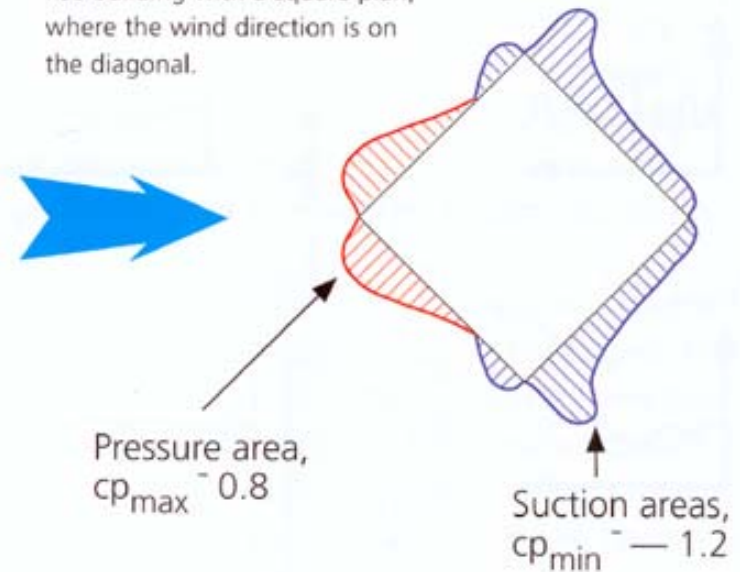

9-5 Right: qualitative pressure distribution around a cylindrical high-rise building.

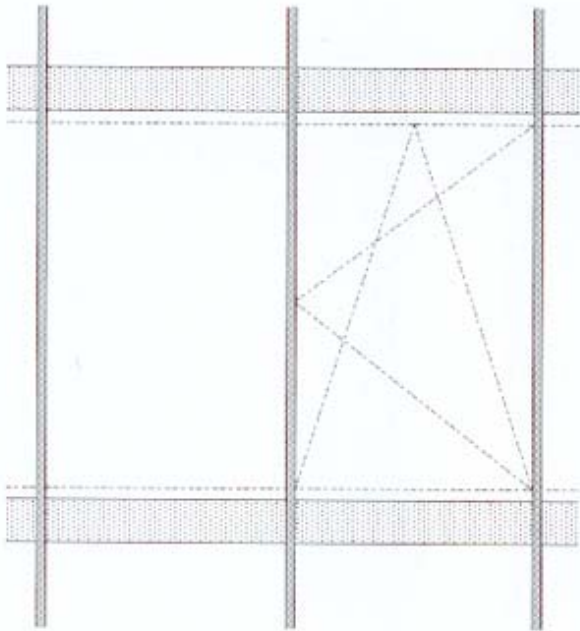

1.21 Elevation of part of a multi-story facade. The arrangement of the casement opening lights depends on the ventilation and cleaning concept chosen for the facade.

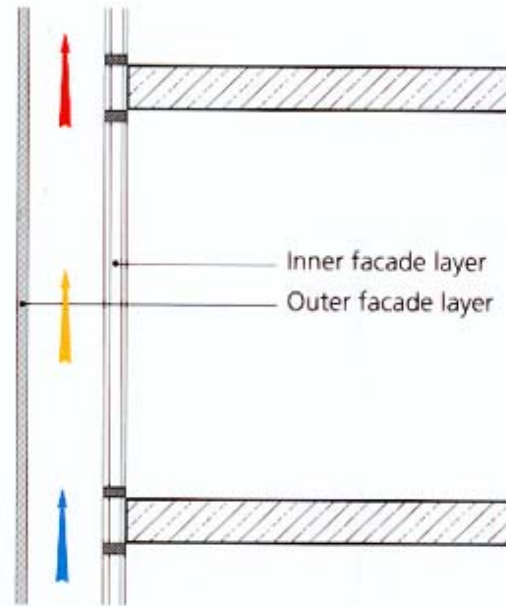

1.22 Section through a multi-story facade. The external skin is set independently in front of the inner facade. The intermediate space can be ventilated in all directions.

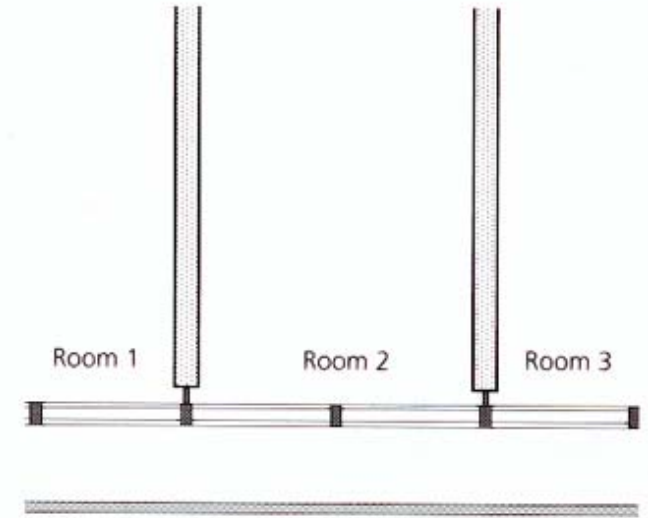

1.23 Plan of a multi-story facade. The intermediate space is undivided and can be freely ventilated.

The Multi-storey Façade Type: the intermediate space between the inner and outer layers is adjoined vertically and horizontally by a number of rooms. In some cases this space may extend around the entire building without any divisions. Air intake is at the bottom, exhaust at the top. Does not *necessarily* require openings all over the exterior of the façade.

Condensation:

One of the largest concerns in cold climates is the potential for condensation in the air space and on elements/surfaces within that space.

The ventilated cavity assists in the rapid removal of humid air that escapes from the interior, either to the exterior or to the interior HVAC system return air, depending on the particular system design.

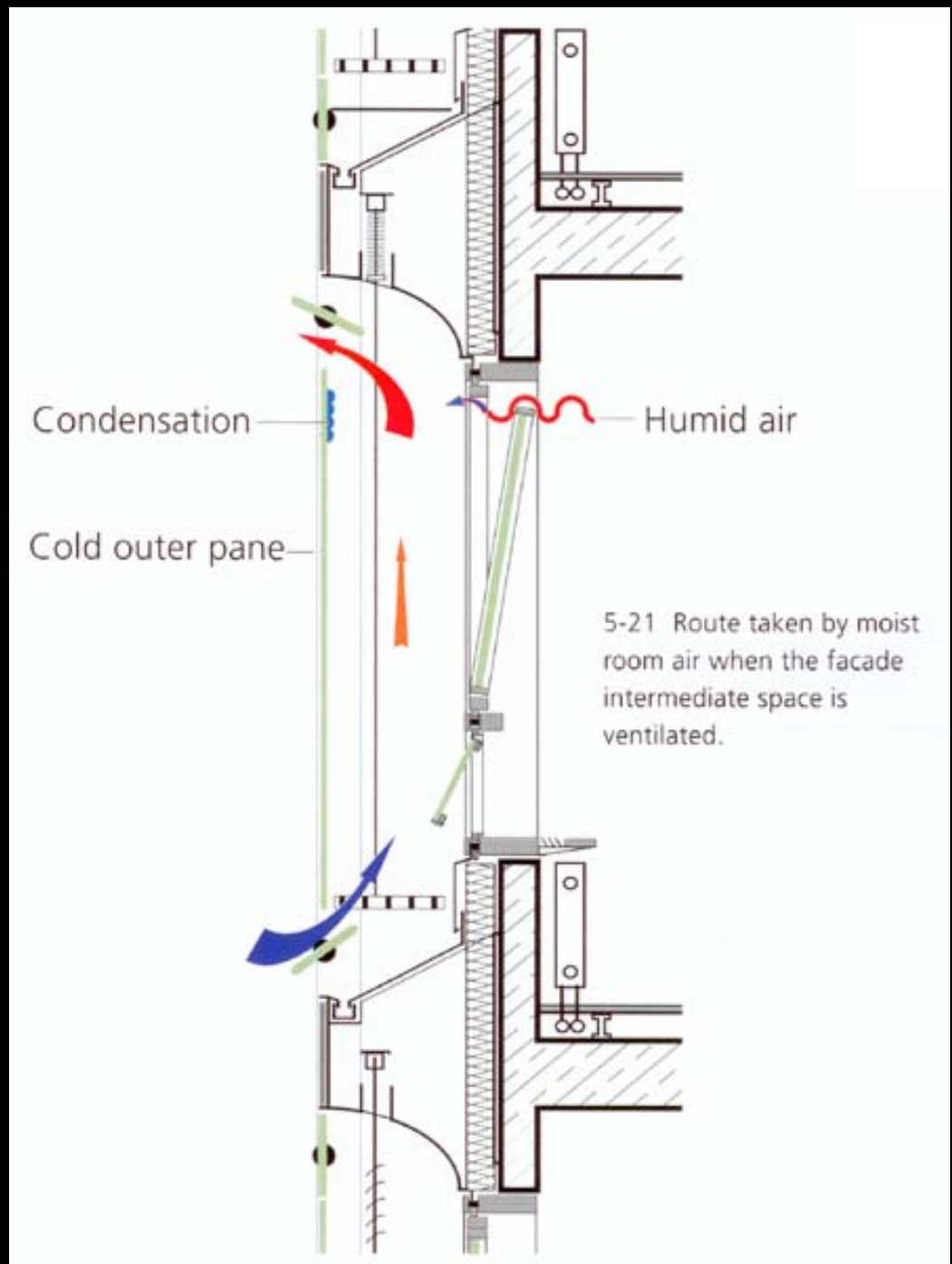

If the façade intermediate space is closed, convection currents will cause the warm moist air to come into contact with the cold outer pane and condense.

This can be alleviated to a certain extent if the outer pane is double glazed versus single glazed. *Normally, these systems double glaze on the exterior and single glaze on the interior.*

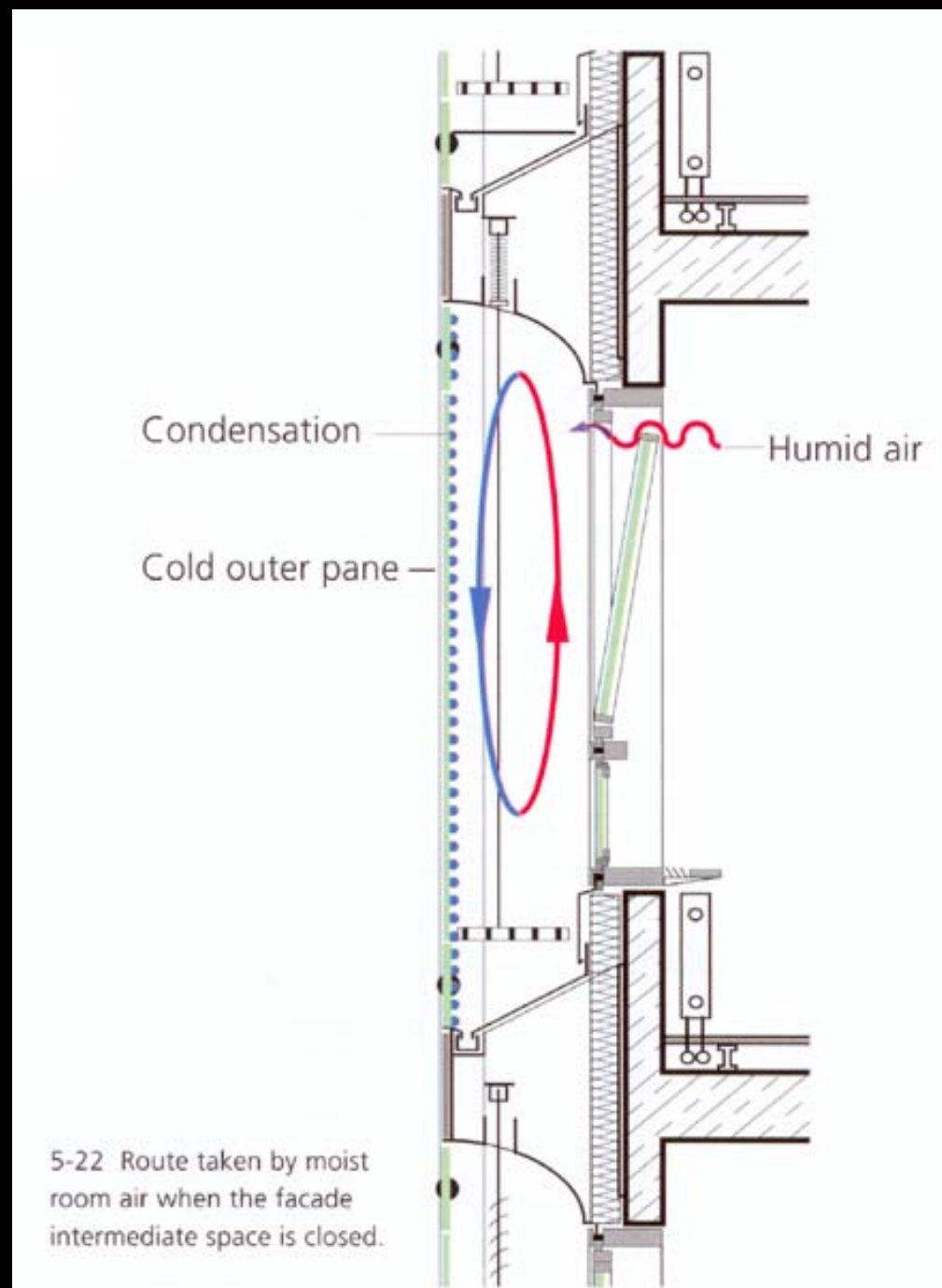

Sunshades in the cavity:

The presence of sunshades in the cavity will alter the heat levels as well as the ventilation paths, depending on the operation and placement of the shades.

Need to ventilate both sides of the cavity to ensure that the interior side is not overheating the room, and that condensation is prevented on the exterior side, adjacent to the glass.

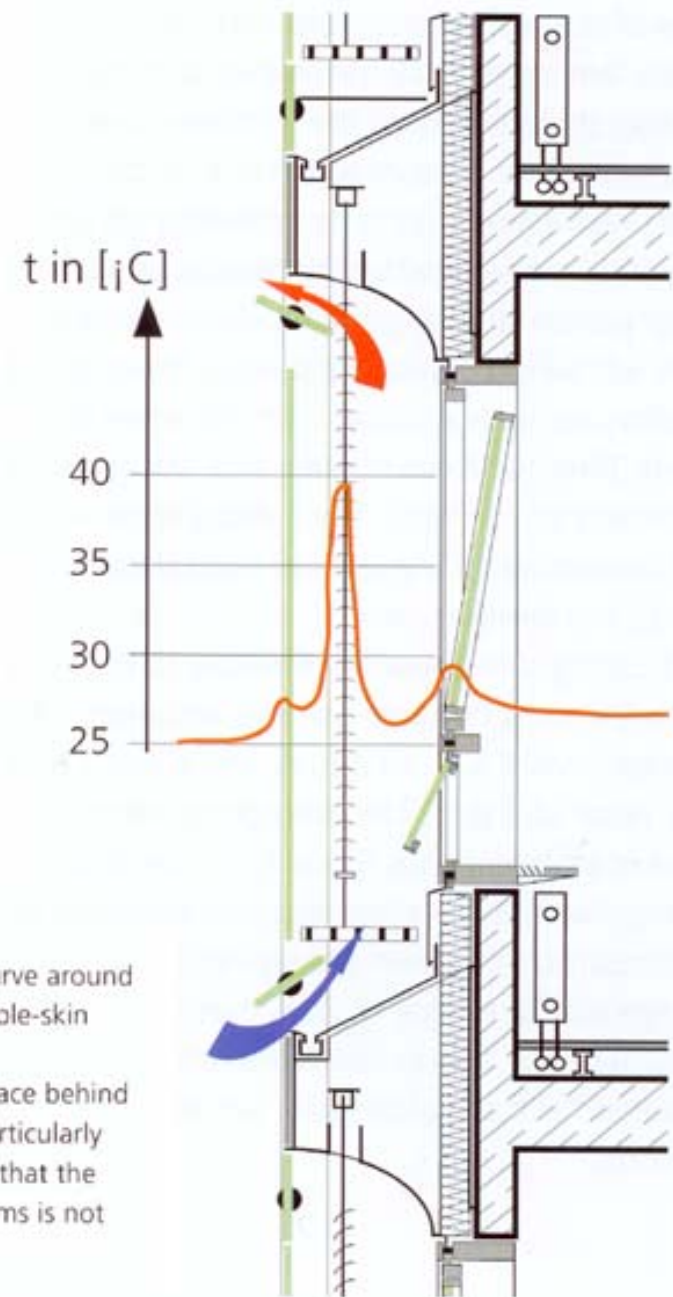

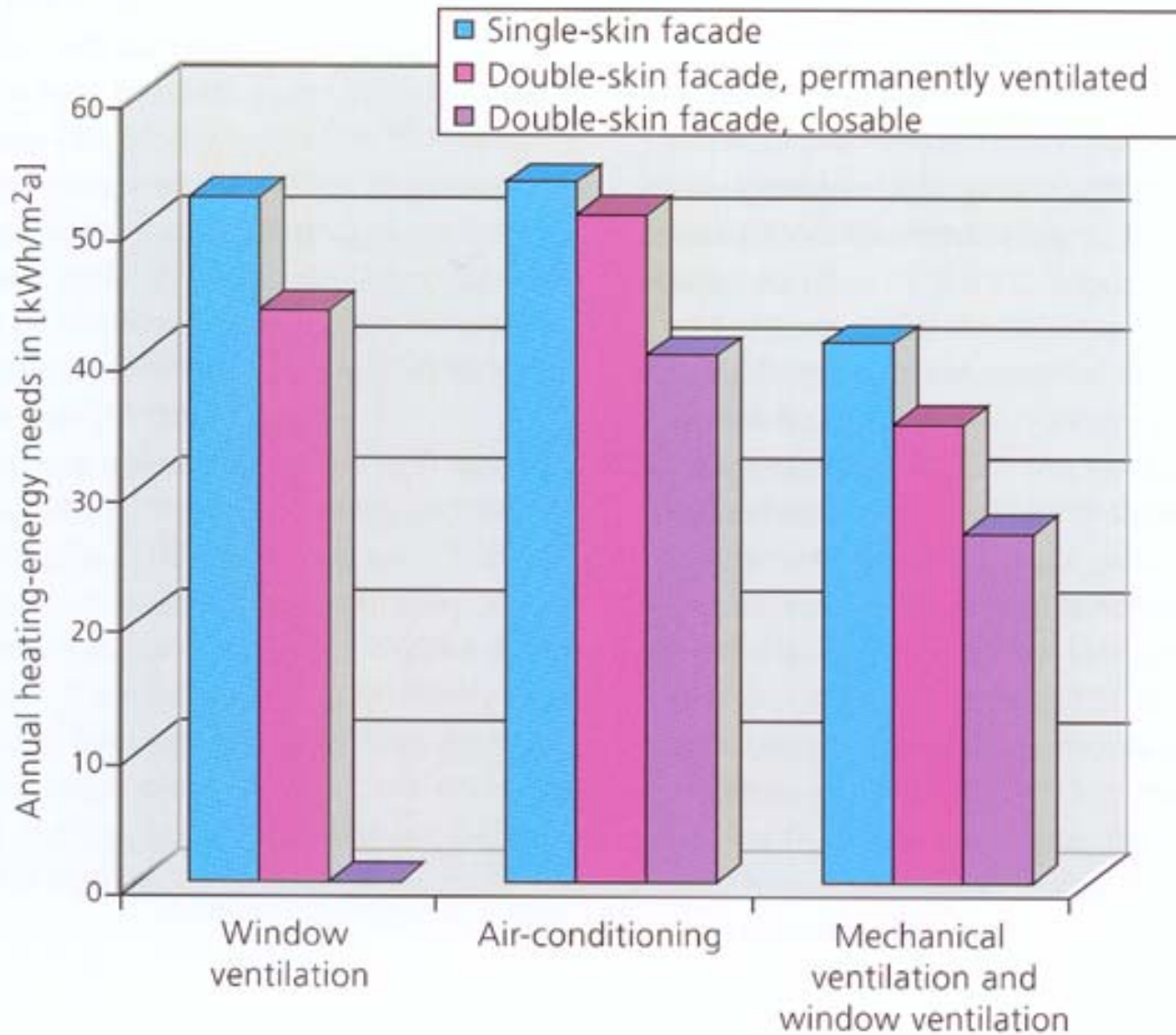

5-23 Data compiled from thermal simulation for building in respect of annual heating-energy needs; calculated as an average for the four faces of the building.

Heating data comparison: single vs. double façade

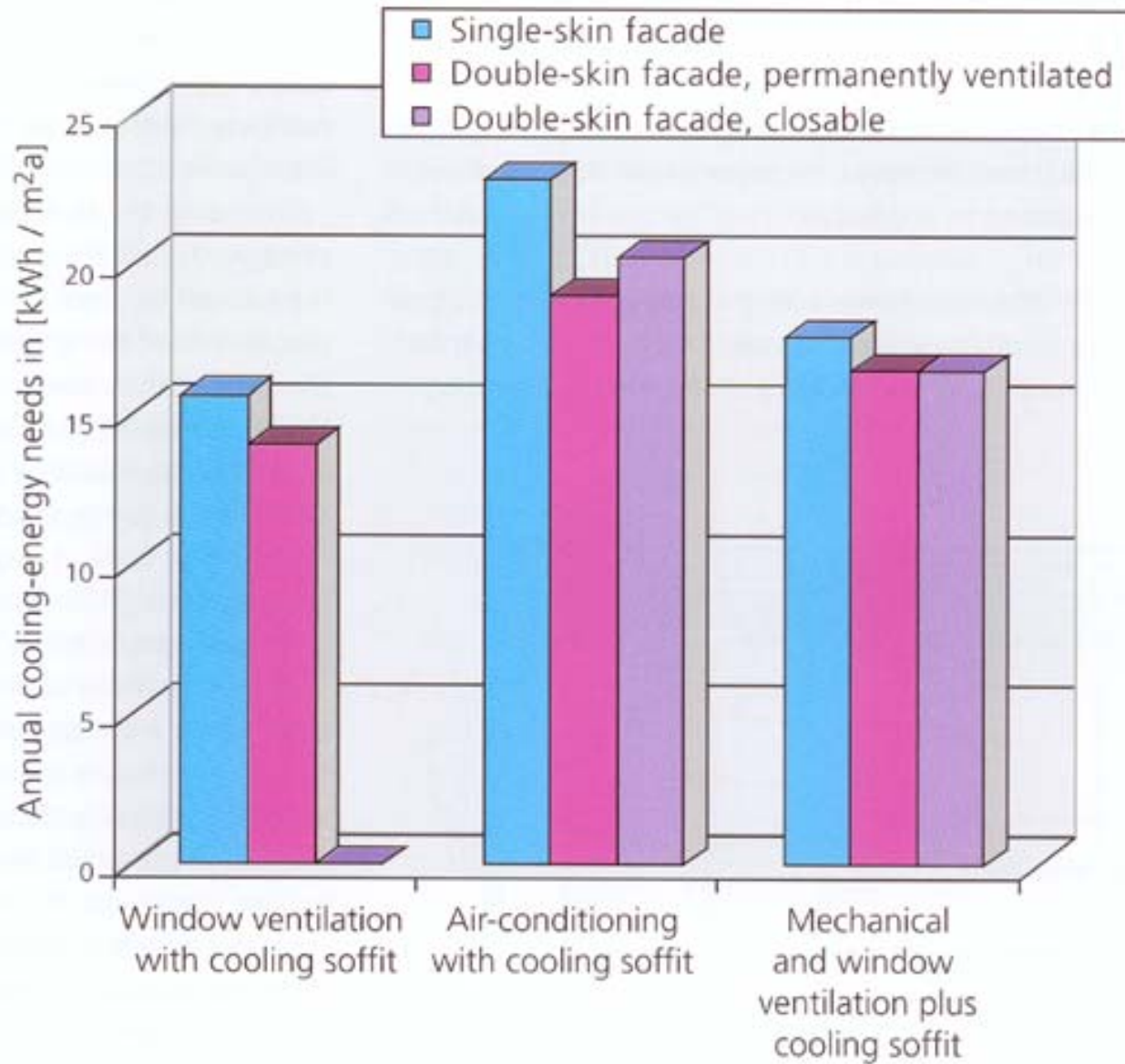

5-28 Annual cooling-energy needs derived from thermal simulation for building; calculated as mean values for a standard story.

Cooling data comparison: single vs. double façade

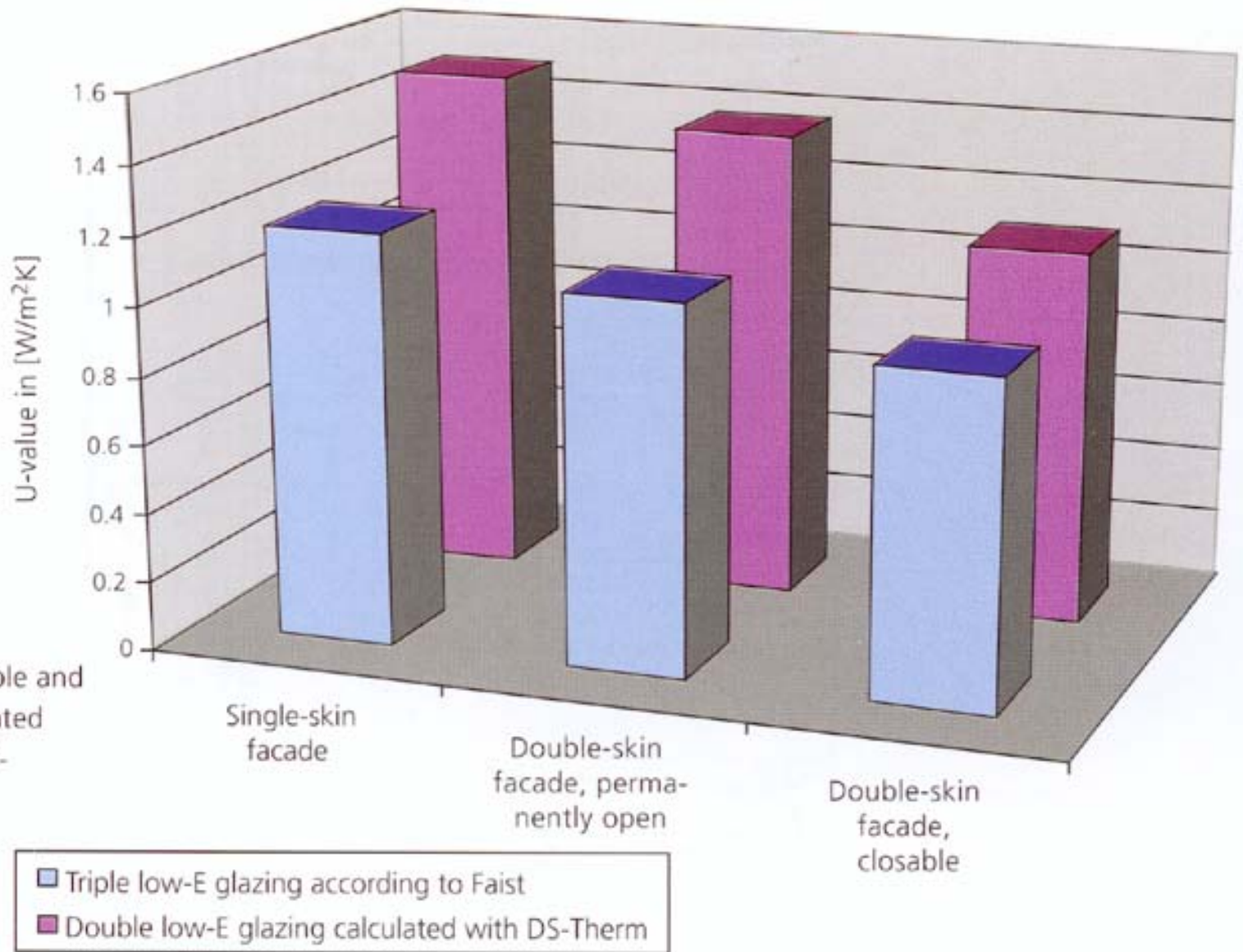

5-10 Improvement of U_w -values for low-E double and triple glazing with ventilated and closable facade intermediate spaces.

Comparison of single vs. double façade for low-e glazing variations

5-9 Equivalent U-value as defined in the thermal insulation regulations currently valid in Germany /T16/, dating from 1995. The coefficient of thermal transmission for a single-skin facade or for the inner layer of a double-skin facade is $U_w = 1.5 \text{ W/m}^2\text{K}$.

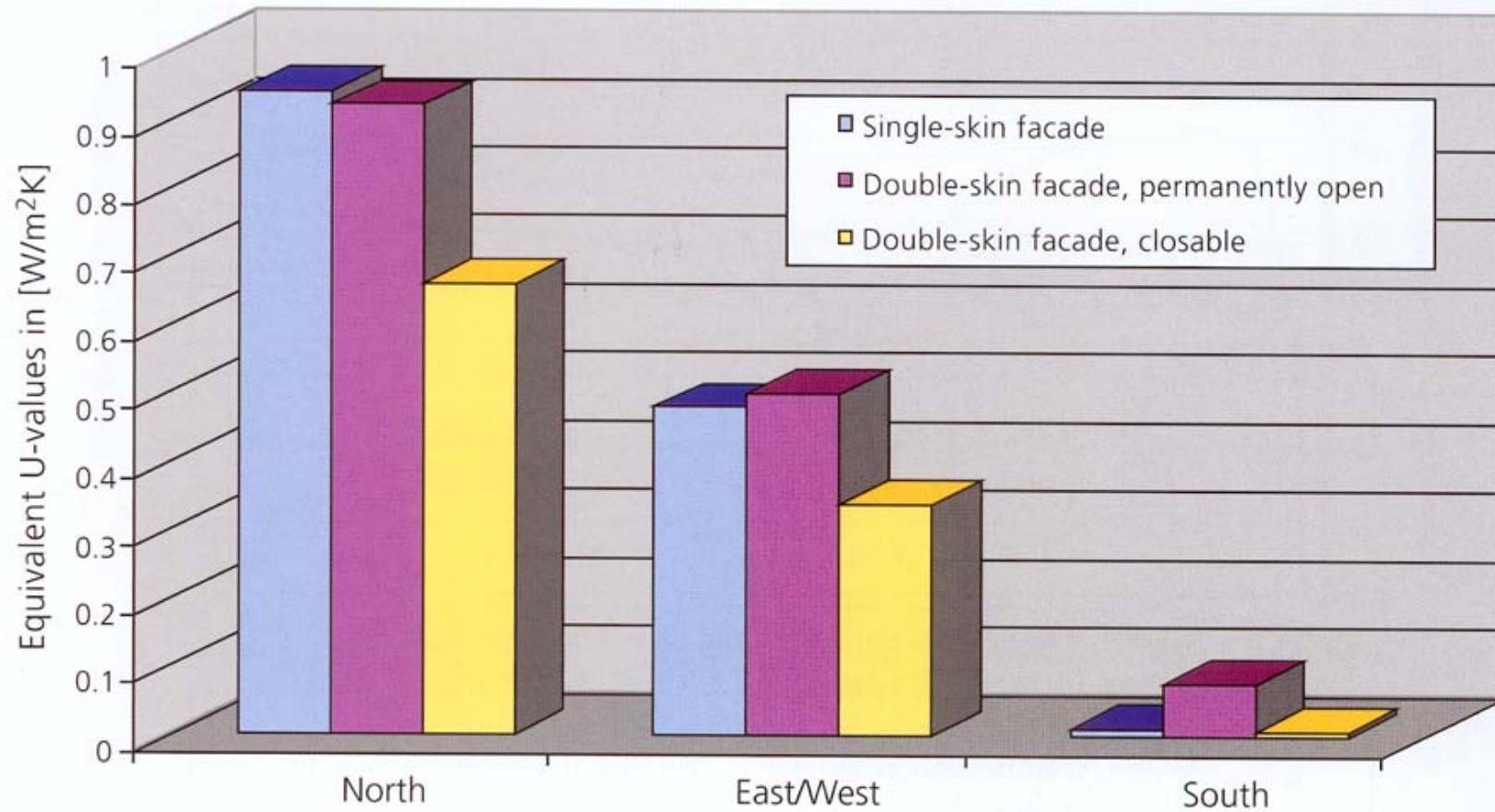

Orientation data comparison: single vs. double façade

Double façade as acoustic barrier:

relevant external noise L_A , measured in decibels
 assessment noise level in room L_r , measured in decibels

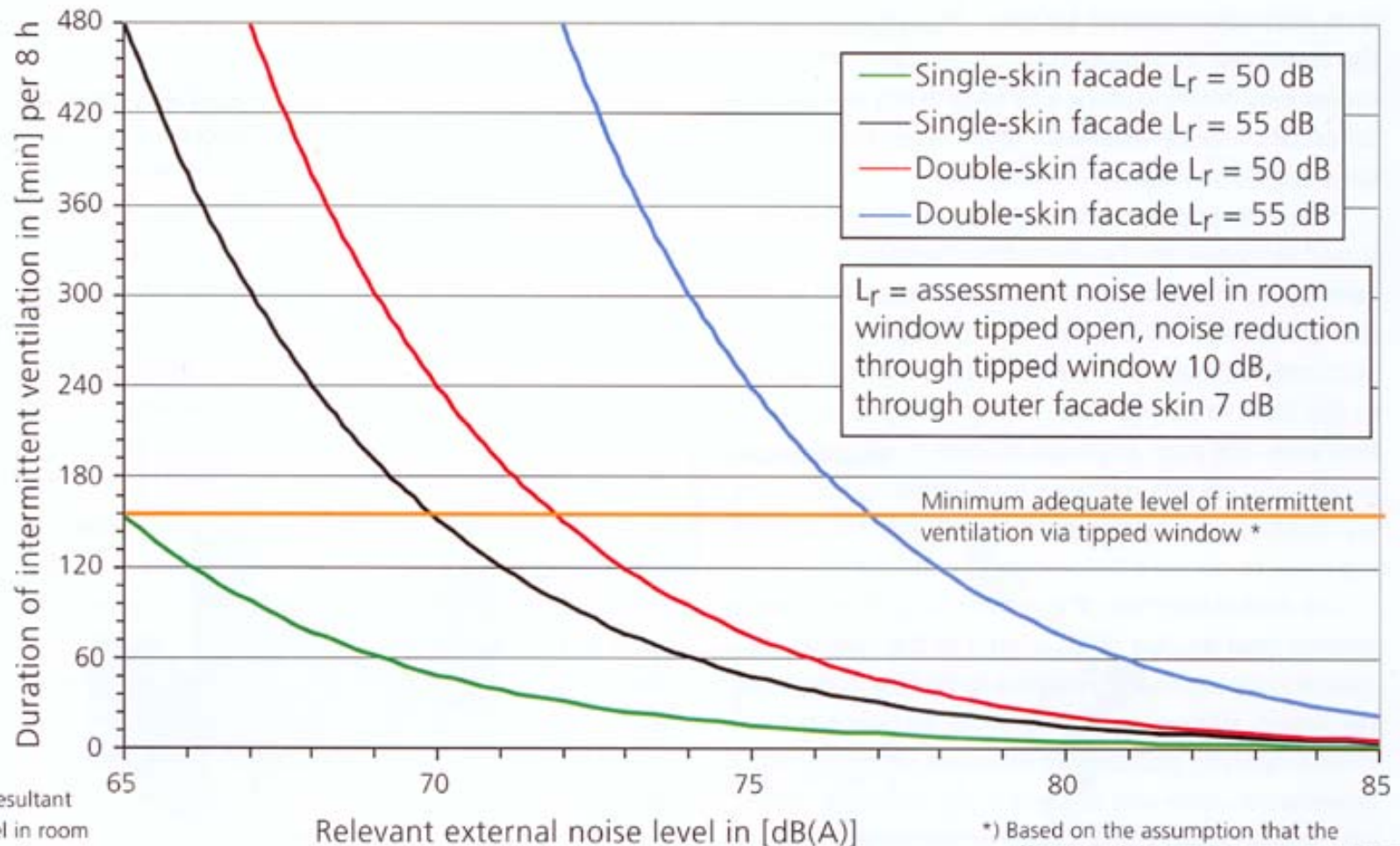

4-4 Nomogram for resultant noise assessment level in room in relation to duration of ventilation and relevant external noise level.

Acoustic screening barrier in front of Neven-DuMont-Schauberg publishing house, Cologne. Architects: Hentrich Petschnigg und Partner, Dusseldorf





London: An extra layer of glazing creates an acoustic buffer against rail noise, while still allowing operable glazing units behind.

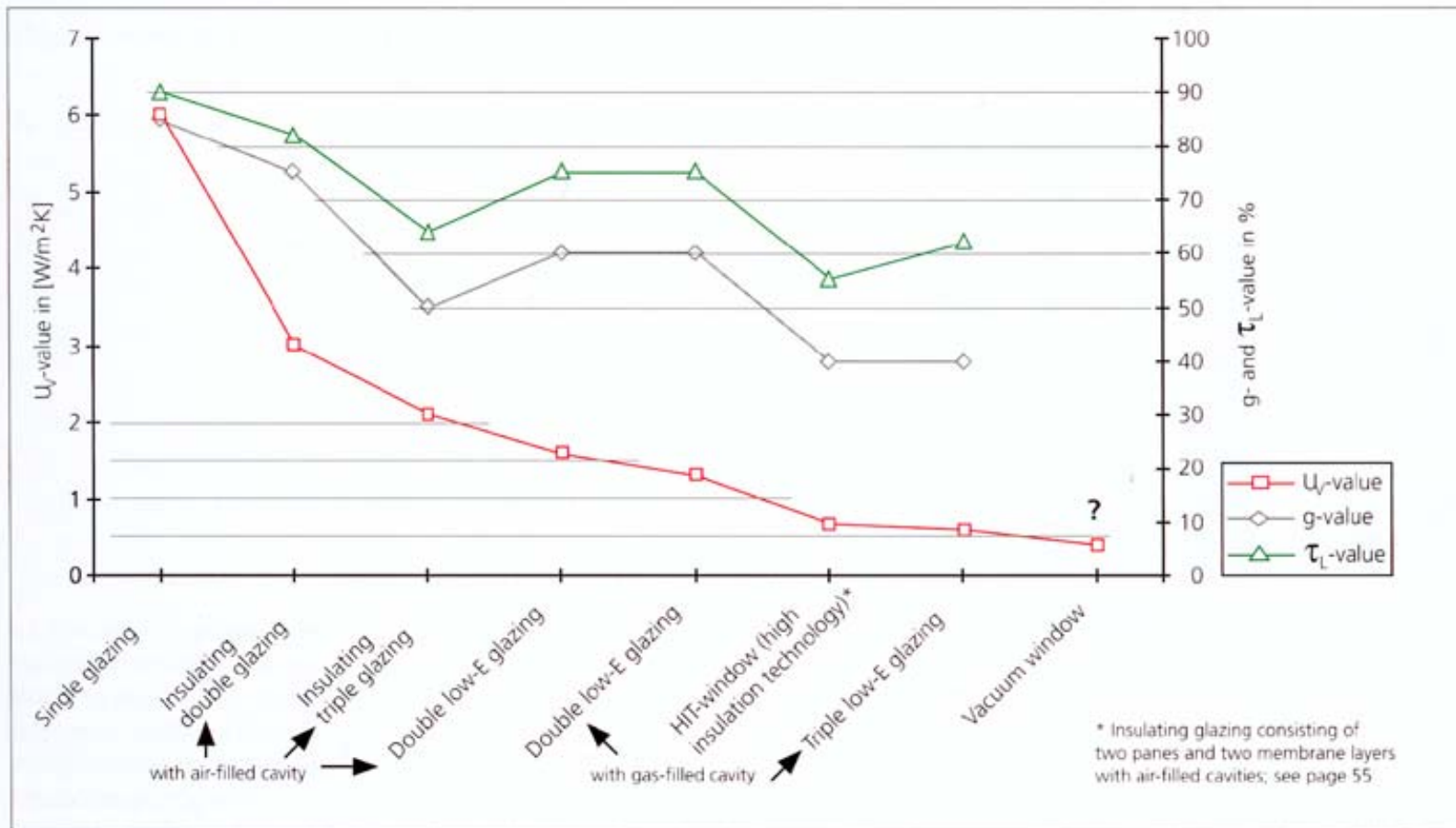

0.2 Development of physical values of various kinds of glazing down to the present day.

U = coefficient of thermal transmission of glazing
 g = total energy transmission factor
 τ_L = light transmittance (for daylight)

Comparison of conduction values for different glazing systems:

Daylighting and the double façade:

Graph of daylight factor in middle of room

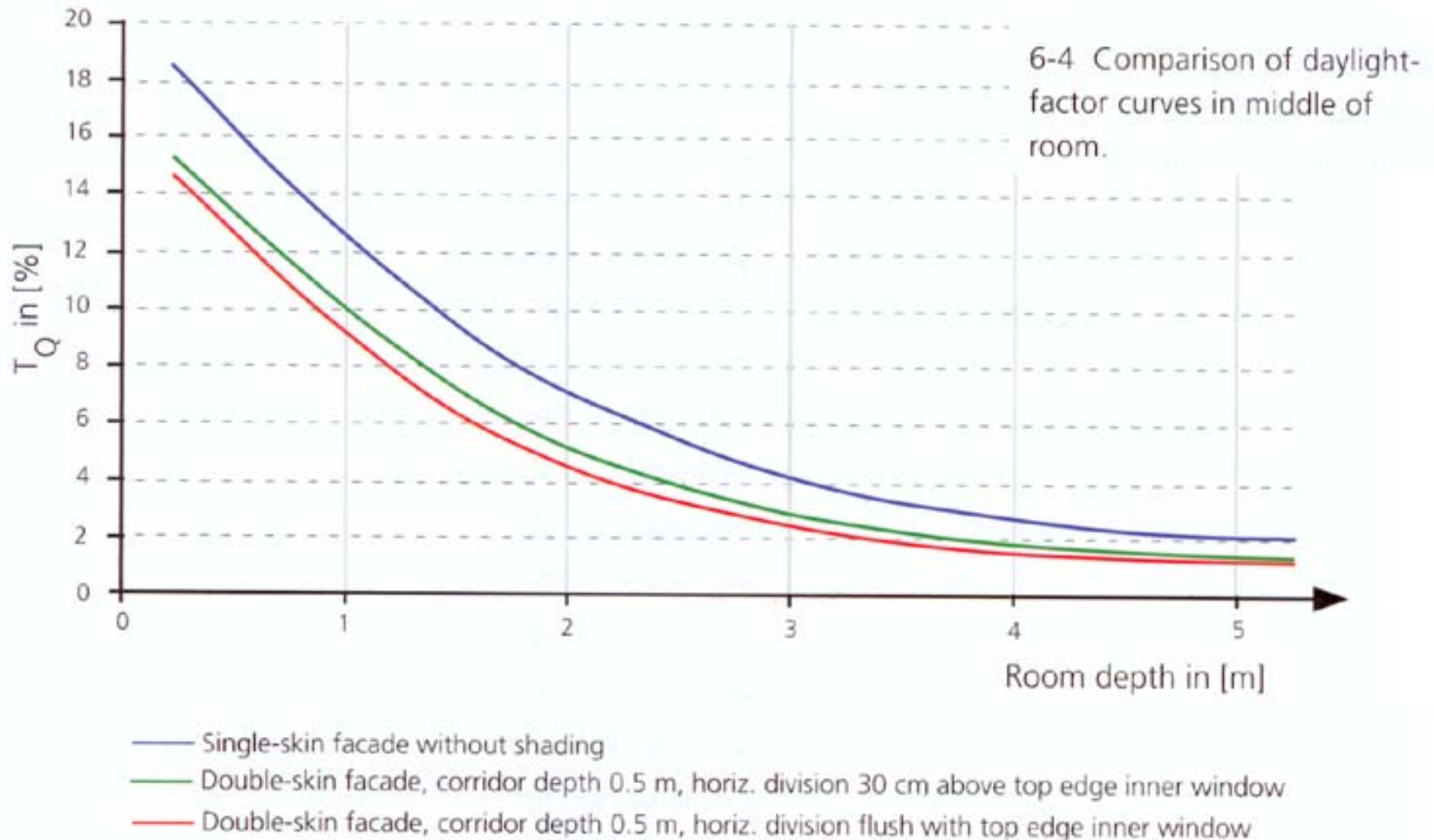

6-1 Daylight-factor curve over the depth of a room with a single-skin facade.

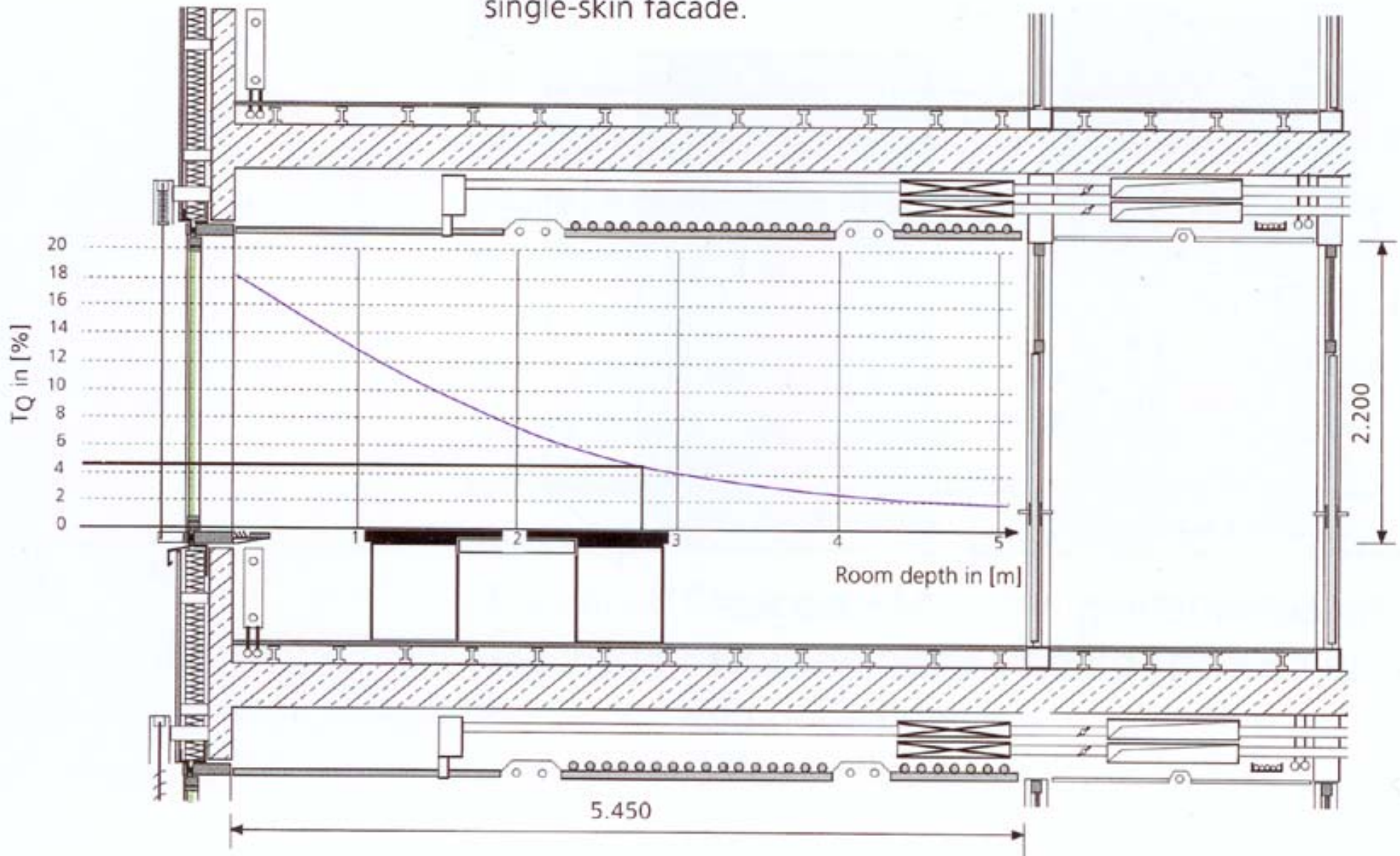

LEED daylight credit requires a minimum DF of 2%

6-2 Daylight-factor curve over the depth of a room with a double-skin facade; projecting top division set flush with soffit.

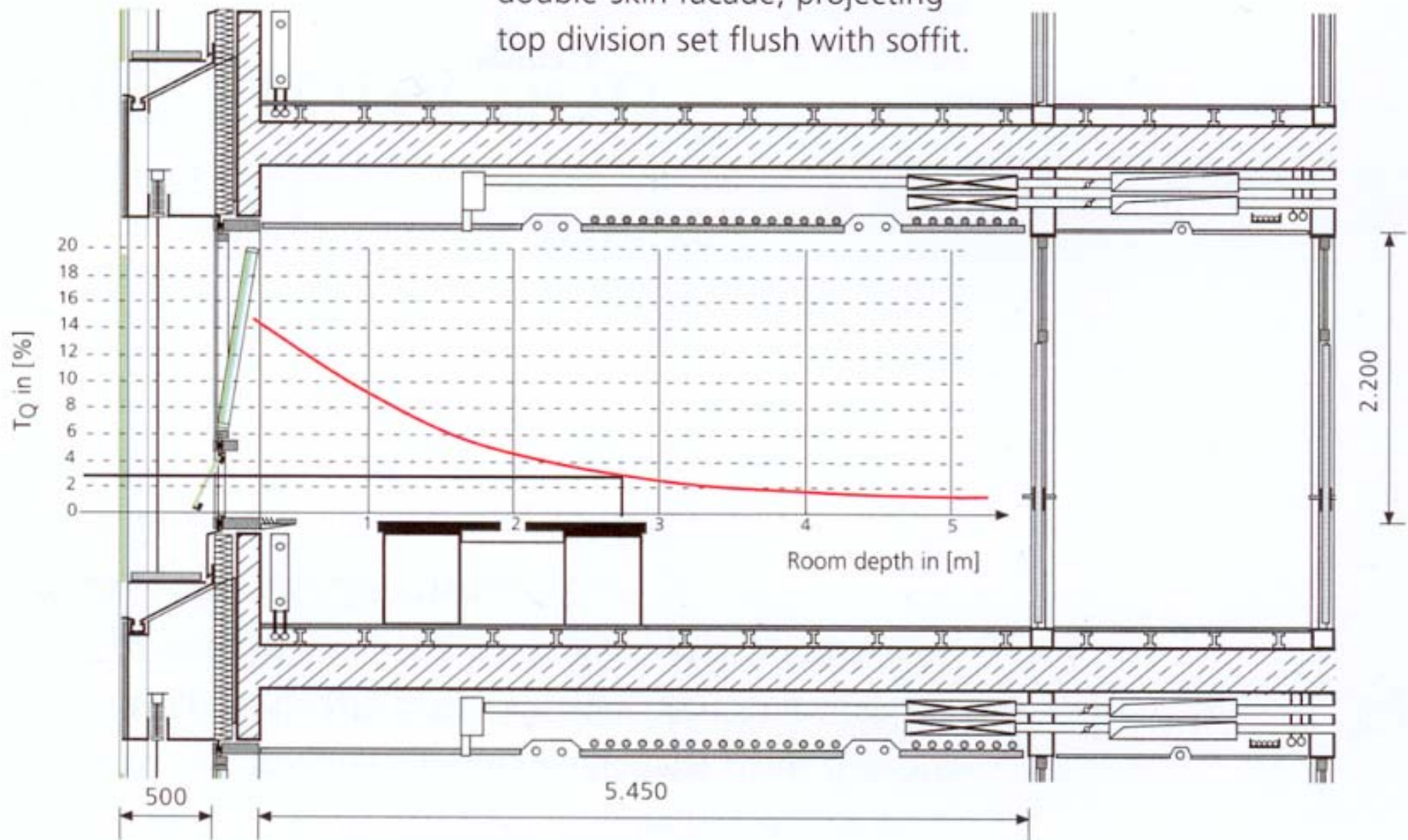

6-3 Daylight-factor curve over the depth of a room with a double-skin facade; projecting top division stepped up from soffit.

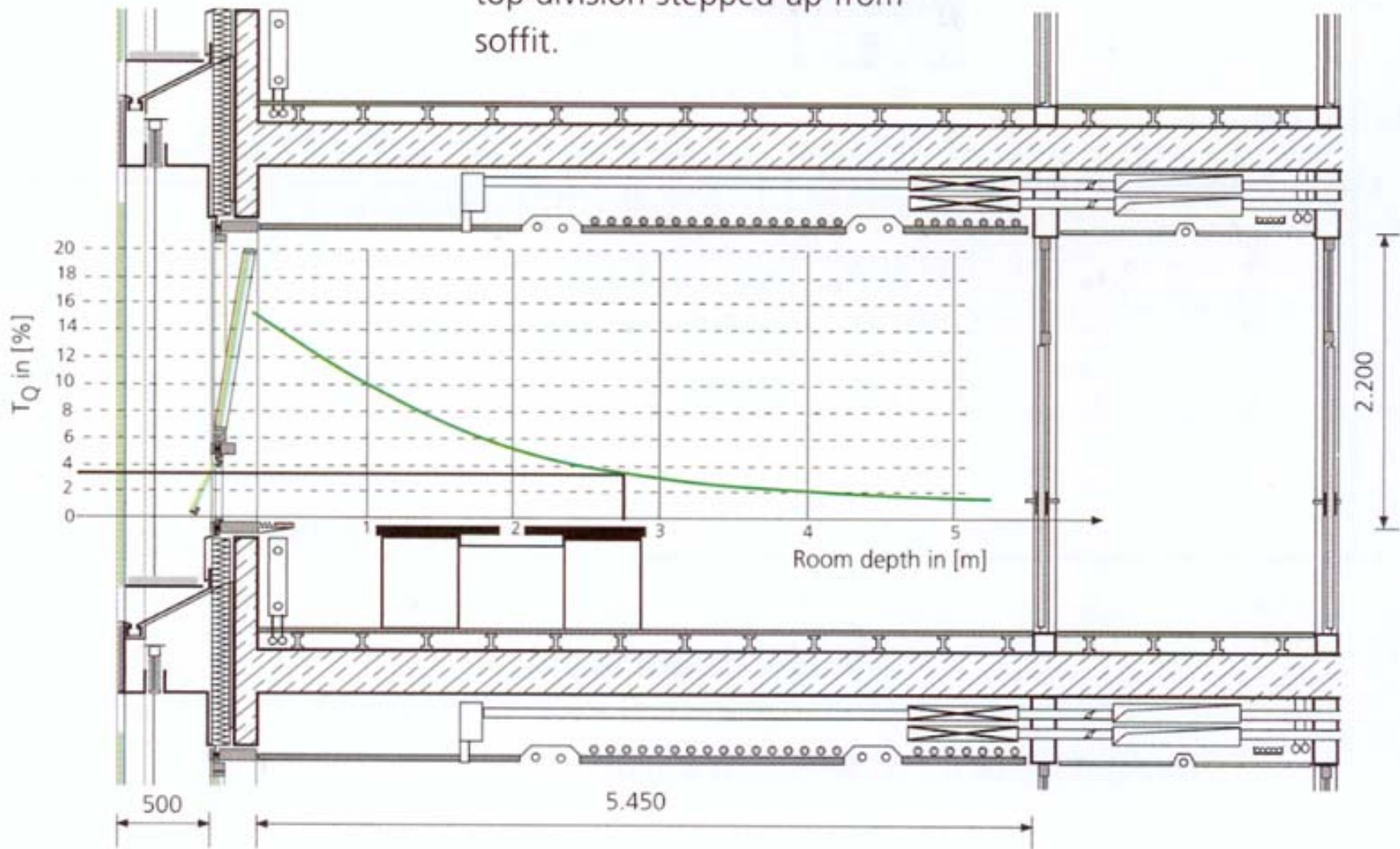

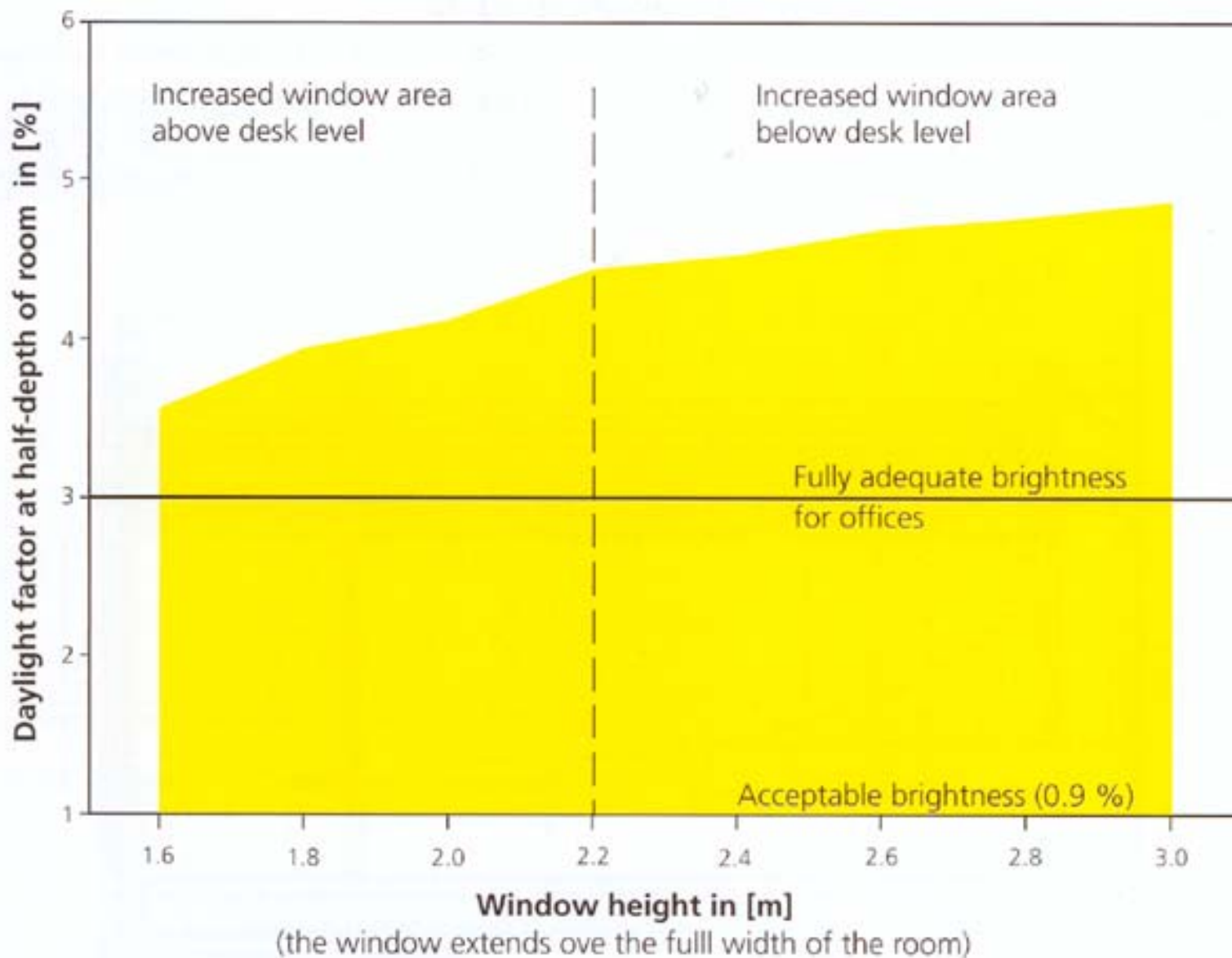

■ Daylight factor for undeveloped situation (light transmittance = 66 %)

6-5 Changes in daylighting levels with increased height of window.

Economic considerations:

Double façade systems will be more expensive than normal curtain wall systems. In order to keep down some of the costs, standardization and larger scale production of the units is necessary.

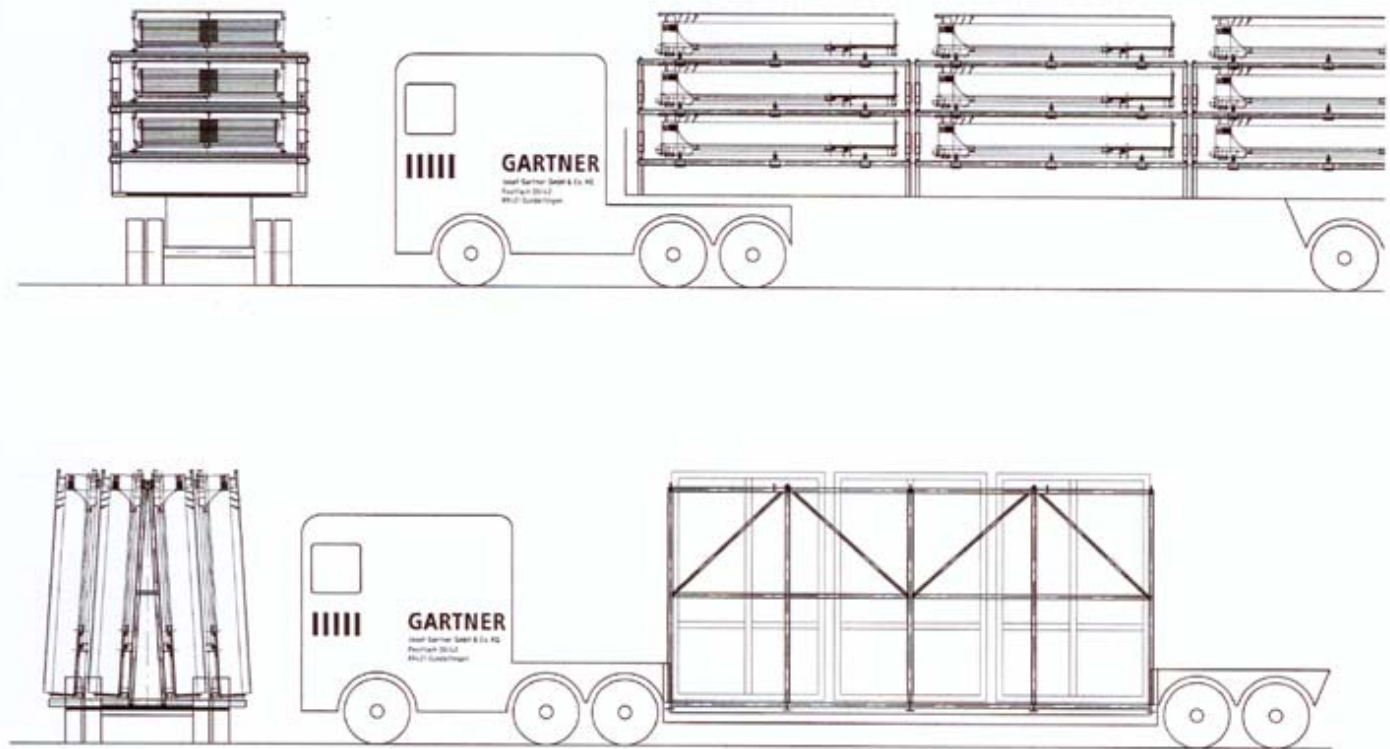

Economies through large-scale production

Economic considerations, continued:

Other significant economic as well as environmental considerations are:

NEGATIVE:

- >embodied energy of DF higher than SF
- >capital costs are higher than SF
- >design costs are higher than SF
- >engineering expertise required
- >contractor expertise and experience required

POSITIVE:

- >IF mechanical systems are designed properly and downsized accordingly, operating costs and space allocations for HVAC will be lower
- >better control and access to daylight
- >higher degree of interior comfort for occupants
- >potentially higher level of user control of façade system
- >access to natural ventilation in building types that have come to deny it

temperate and cold
climate
case studies:

30+ years of double skin
building

Telus Building, Vancouver | Busby + Associates



Cold and Temperate Climate Issues

- All early examples were constructed in cold and temperate climates
- Need to balance heating and cooling needs
- Examine degree-days to determine which climate dominates (Climate Consultant recommended)
- Design for daylighting balanced with passive heating AND solar avoidance for cooling
- Beneficial to have shades protected in the air corridor as these will be essential to balance heating and cooling needs
- Cleaning and maintenance issues with the air corridor

Occidental Chemical, Niagara Falls, 1981

Cannon Associates

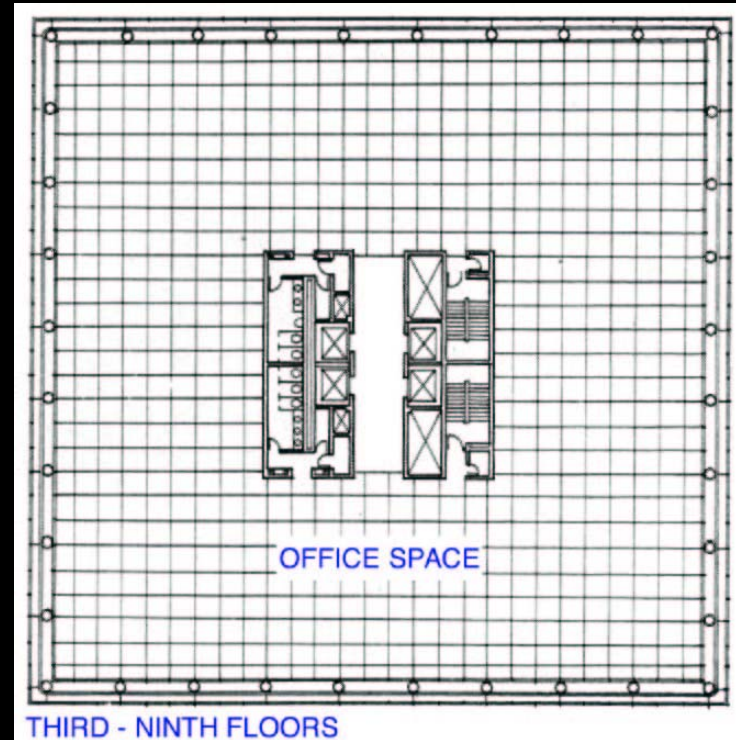

This building is cited in most texts as the first real double façade building. It uses a **buffer façade** system. The cavity is 1.5 m by 9 m high with open louvers at the top and bottom of the cavity. Shading devices are installed in the cavity. The building was performing better than expected until most of the systems failed in the late 1990s. As a result the shading louvers are fixed and the building is reported to be either too hot or too cold most of the time.

Occidental Chemical, Niagara Falls, 1981

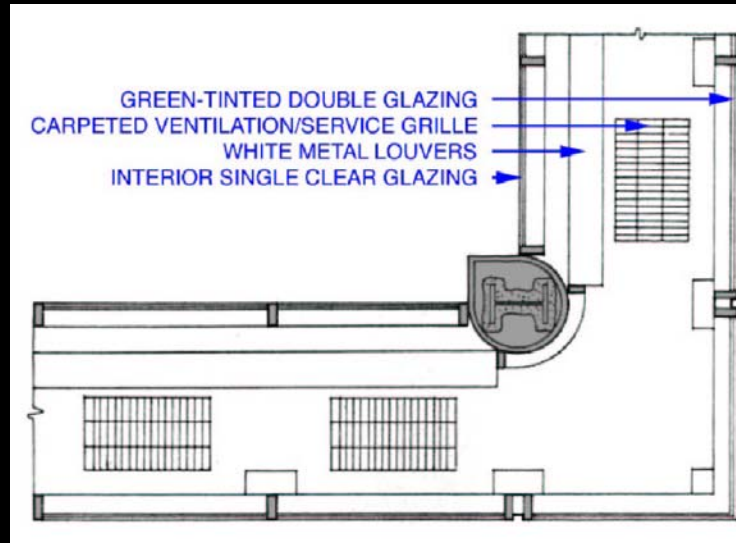

Here we see the details of the buffer cavity. The overall width is around 1.5 meters. It runs unobstructed from the bottom to the top and is not broken at the corners. Intake air is admitted at the base and exhausted at the top. Other than tempering the temperature of the cavity, this air is not mixed with the office air.

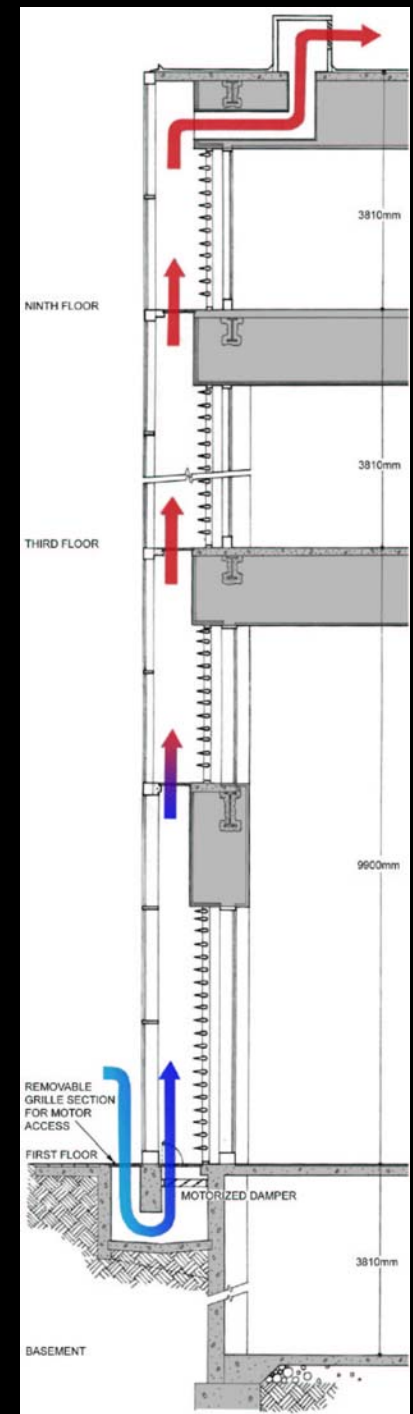

Occidental Chemical, Niagara Falls, 1981



- The Occidental Chemical building also goes by the name Hooker
- It is a classic buffer façade system
- The Occidental Chemical Building (Hooker) is a classic undivided air space
- It also boasts the classic problems: intake of dirt at base that is spread to the top
- as this buffer façade does not have any operable windows, noise cannot be transmitted from office to office

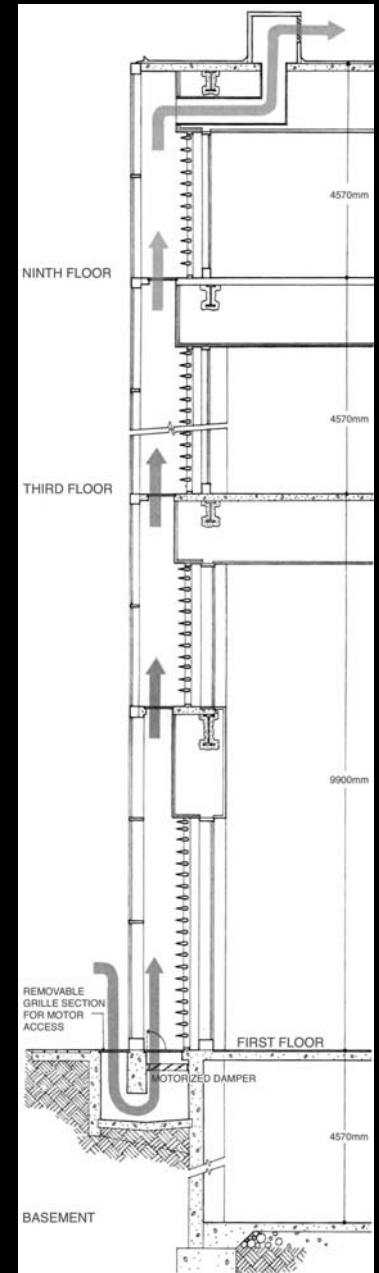

Occidental Chemical, Niagara Falls, 1981



The façade has deteriorated over the years. You can see the clouding on the glazing system. This intake vent is damaged and full of debris from the construction adjacent.



Occidental Chemical, Niagara Falls, 2006



A visit in June 2006 revealed that all of the shading had been removed from the buffer space, and the ground floor renovated into a T-shirt and souvenir shop.



Telus Building, Vancouver, Busby Associates, 2001:



Existing Façade

ADAPTIVE REUSE:

Where the Telus Building differs from most all other double façade systems is in its classification as a renovation rather than 100% new construction. The second skin was able to allow for the retention of most of the existing structure and therefore save material costs. The existing concrete structure acts as thermal mass inside the cavity and assists with buffering heat transfer.

The system is **twin-face**.



Renovated Façade

Telus Building, Vancouver, Busby Associates, 2001:



Dampers open



Dampers closed

The twin face façade has been added to the south and west sides of the building. The north and east facades either border along a property line and are blank or adjoin another building.

The double façade is approximately 1.2 m wide and runs clear from the base to the top of the building. There are controllable grilles at the bottom which are closed during rush hour or as a function of the exterior temperature.



View of side of added skin



Operable windows

Telus Building, Vancouver, Busby Associates, 2001:

These diagrams illustrate the *predicted* air flow in the building in winter and summer conditions.

In the winter the dampers are closed, allowing the heat to build up and transfer heat through the thermal mass provided by the existing concrete exterior wall.

In the summer the façade is fully vented, thereby effecting cooling and allowing for user controlled natural ventilation.

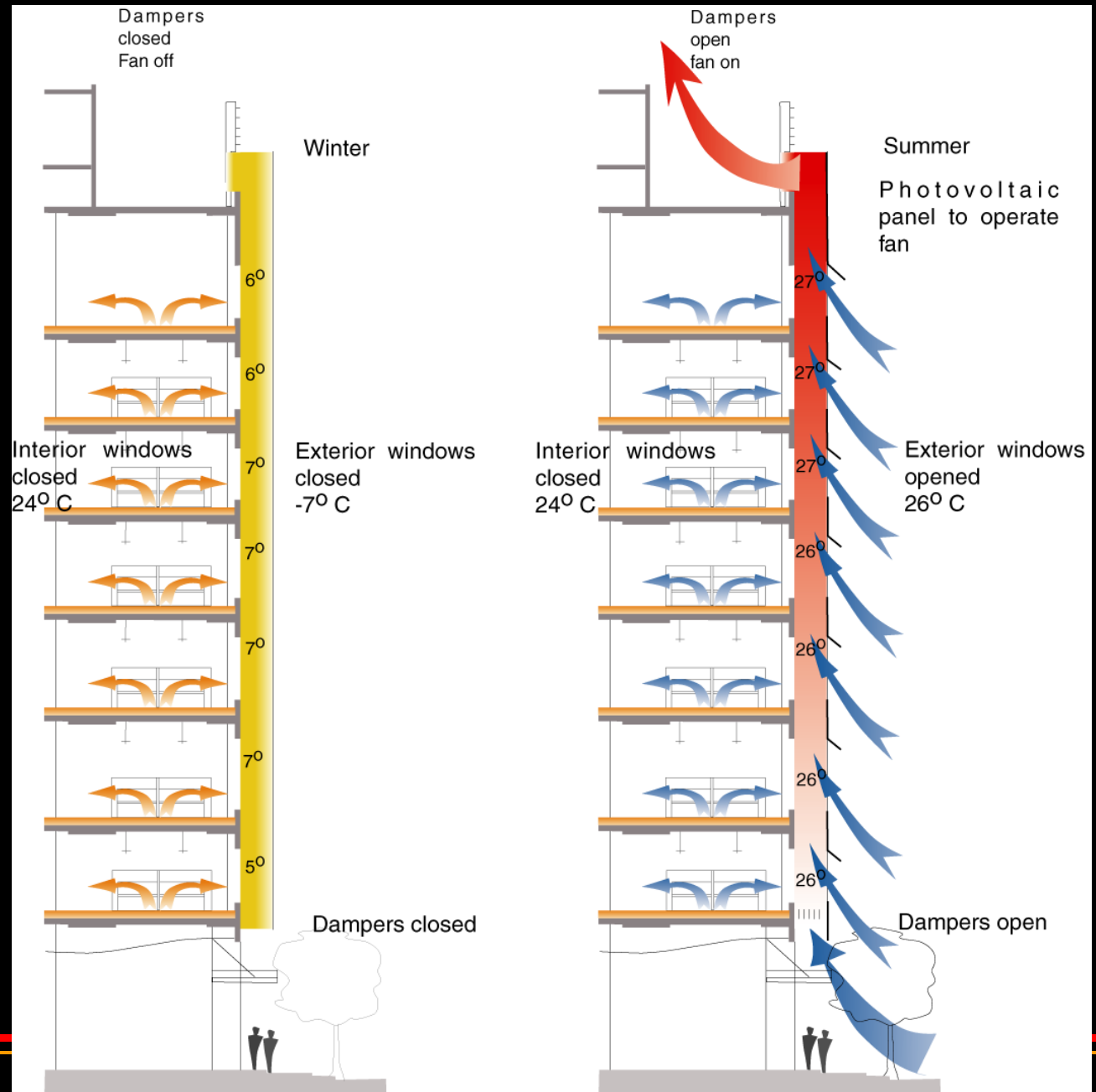

Telus Building, Vancouver, Busby Associates, 2001:

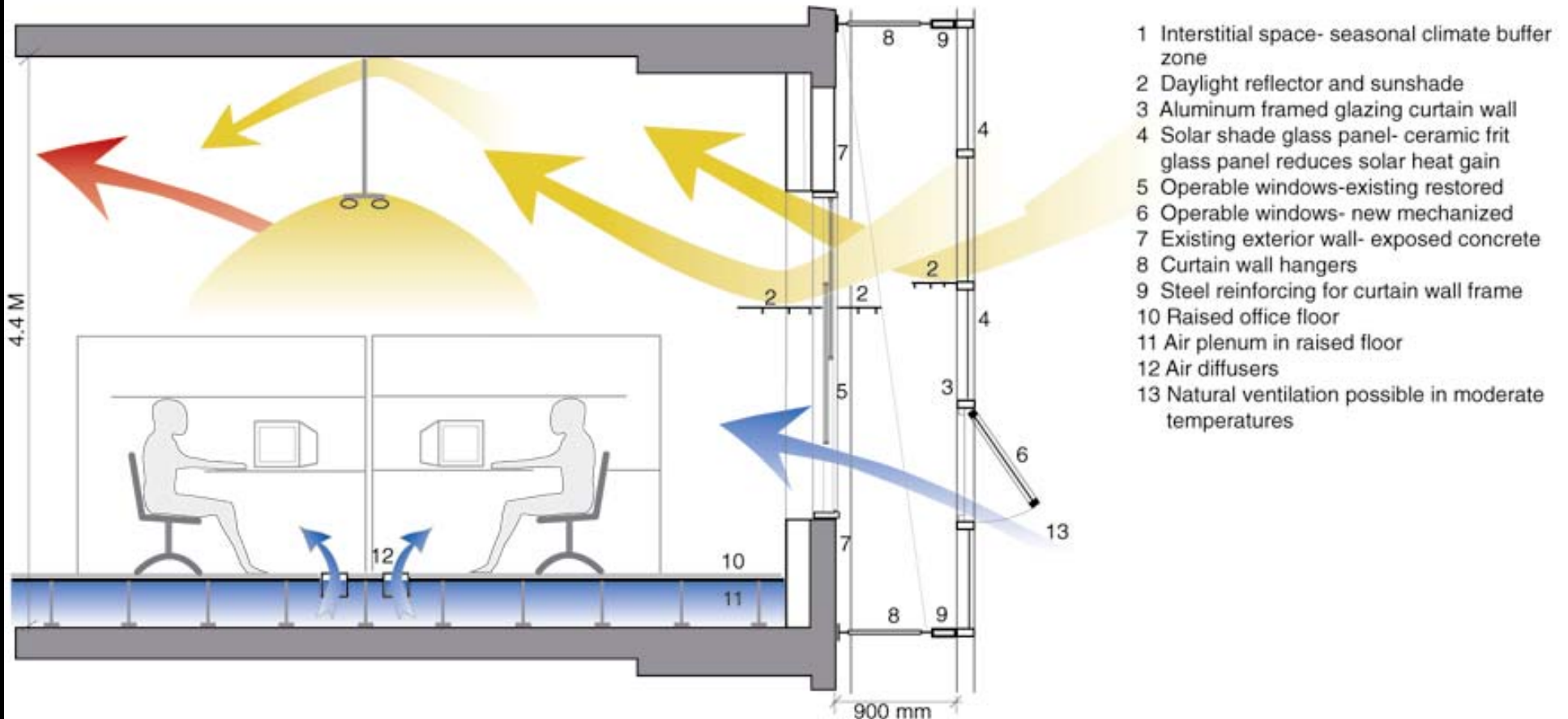

This section shows how the room is intended to function. The exterior glazed wall incorporates operable windows, clear vision glazing and ceramic frit glazing to absorb some of the sun's heat and block a certain amount of solar gain. The existing interior windows were able to be retained at great cost saving. User control is provided for in the access to natural ventilation. Elaborate sun shades are not provided, but the small proportion of glass to solid wall ratio of the existing ratio blocks a great deal of solar.

Telus Building, Vancouver, Busby Associates, 2001:



Views inside cavity

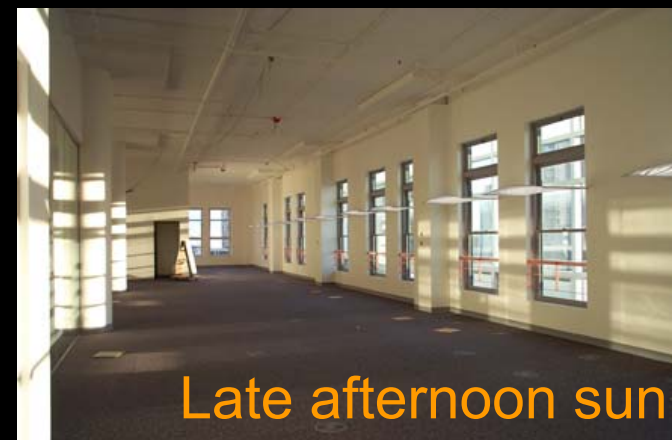

Interior shades

Caisse de dépôt et placement du Québec (CDPQ) - Montreal, 2002



Eric Gauthier Architect with Andre Potvin University of Laval double skin design



The CDP is the one of the few double façade buildings to be constructed in a severely cold climate. It incorporates operable windows, solar shading devices and attention to details to obtain a high quality interior environment.

Caisse de dépôt et placement du Québec (CDPQ) - Montreal, 2002

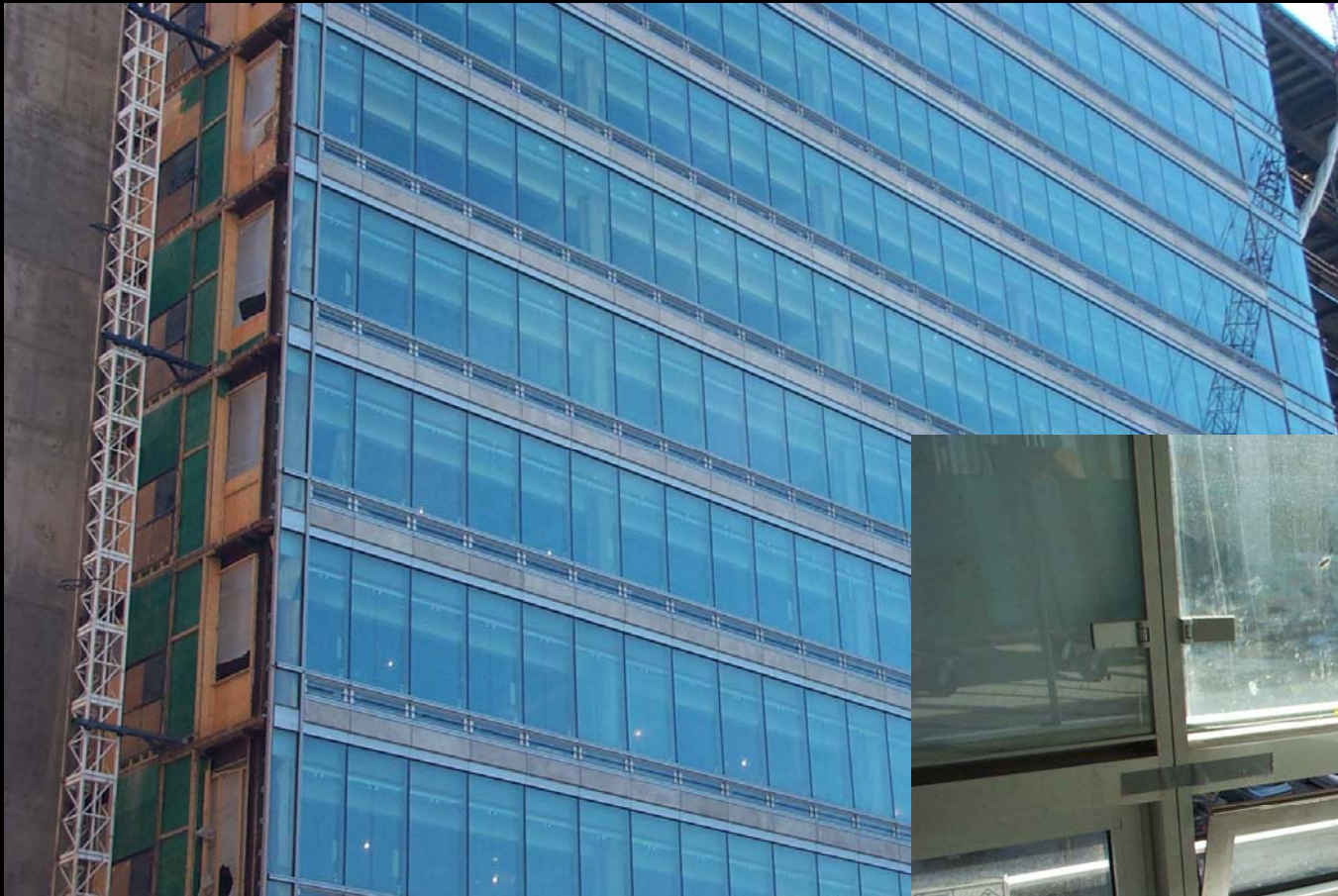

The CDP uses a **hybrid** skin system. Part of the wall operates as a twin face system and the operable windows sit in a band around the building that is a classic operable window system.



Caisse de dépôt et placement du Québec (CDPQ) - Montreal, 2002



The façade system combines an operable band of windows with a thin double glazing system. The exterior skin is basically a curtain wall. Inside a cavity of around 100mm is an additional layer of glazing. This layer is operable for cleaning. There is also a small gap at the base of this glass to draw interior air into the plenum formed by the two sets of glazing. This air is drawn at the top of the cavity into the return air of the mechanical system, therefore gaining heat in the winter months.

Caisse de dépôt et placement du Québec (CDPQ) - Montreal, 2002



The interior access is problematic for cleaning as furniture needs to be moved.



Here we see on the left the interior layer of glass open. Not present at the time of this visit were the electronic blinds that were fitted into the cavity which would provide user control for unwanted sun and glare.

Caisse de dépôt et placement du Québec (CDPQ) - Montreal, 2002



This section shows the overall construction of the wall system.

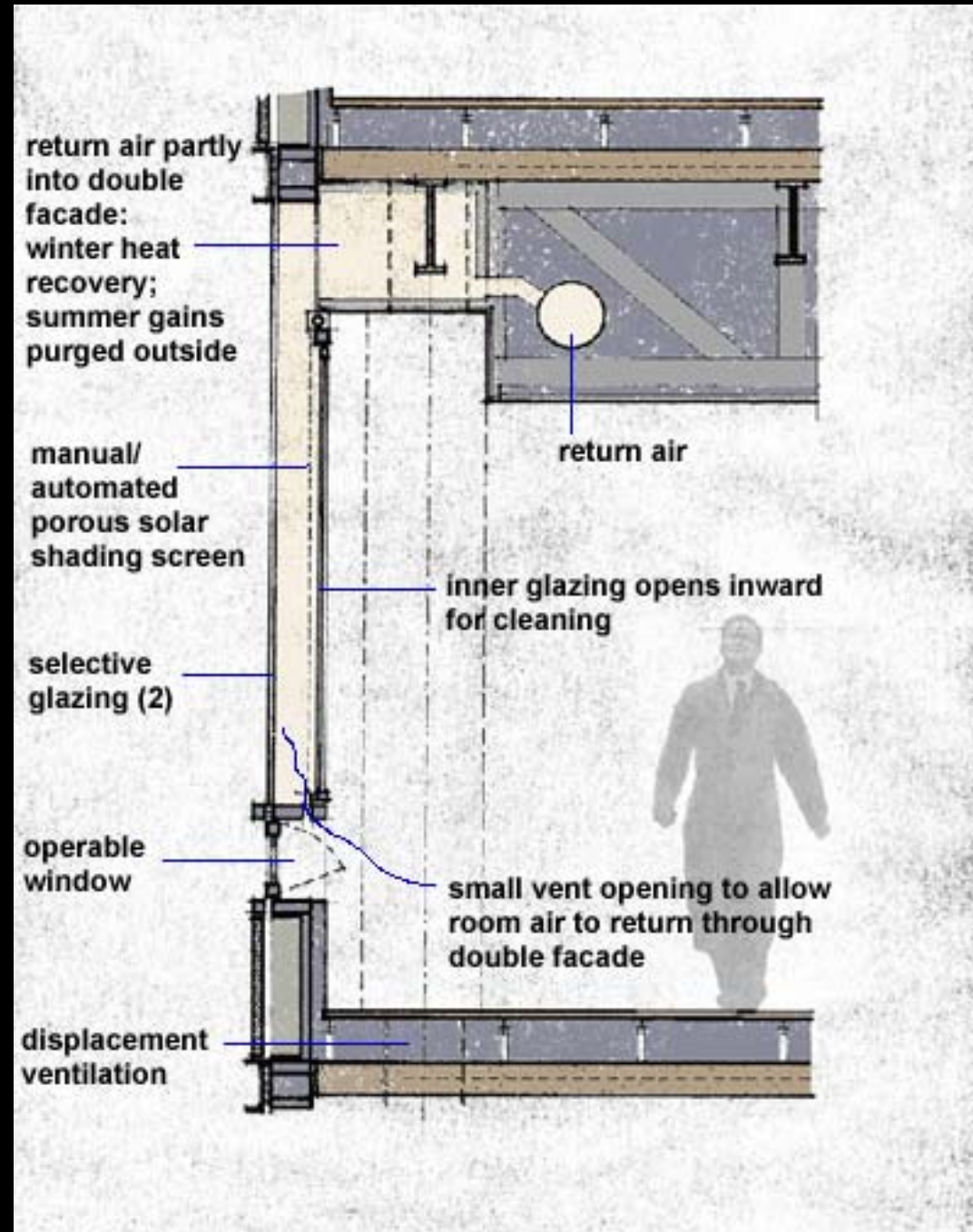

Caisse de dépôt et
placement du Québec
(CDPQ) - Montreal, 2002

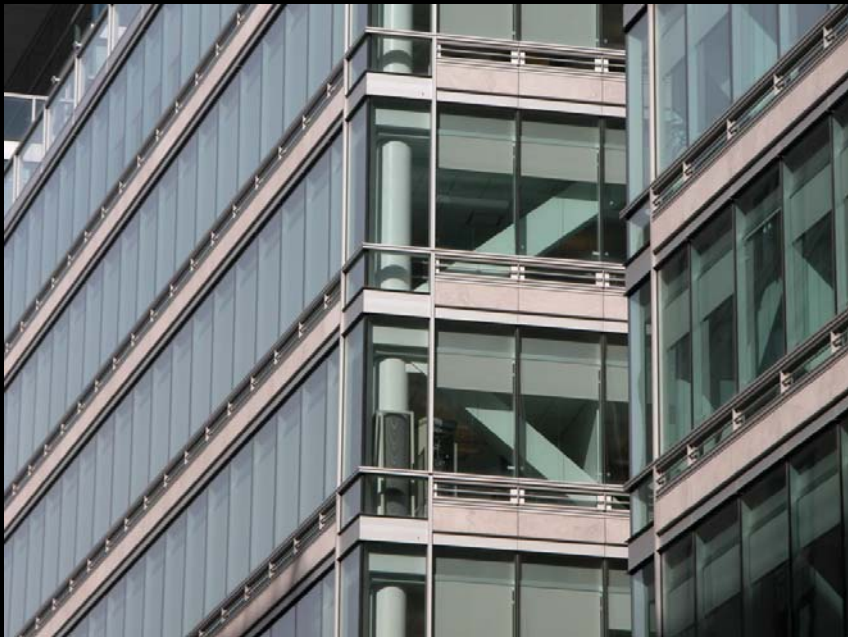
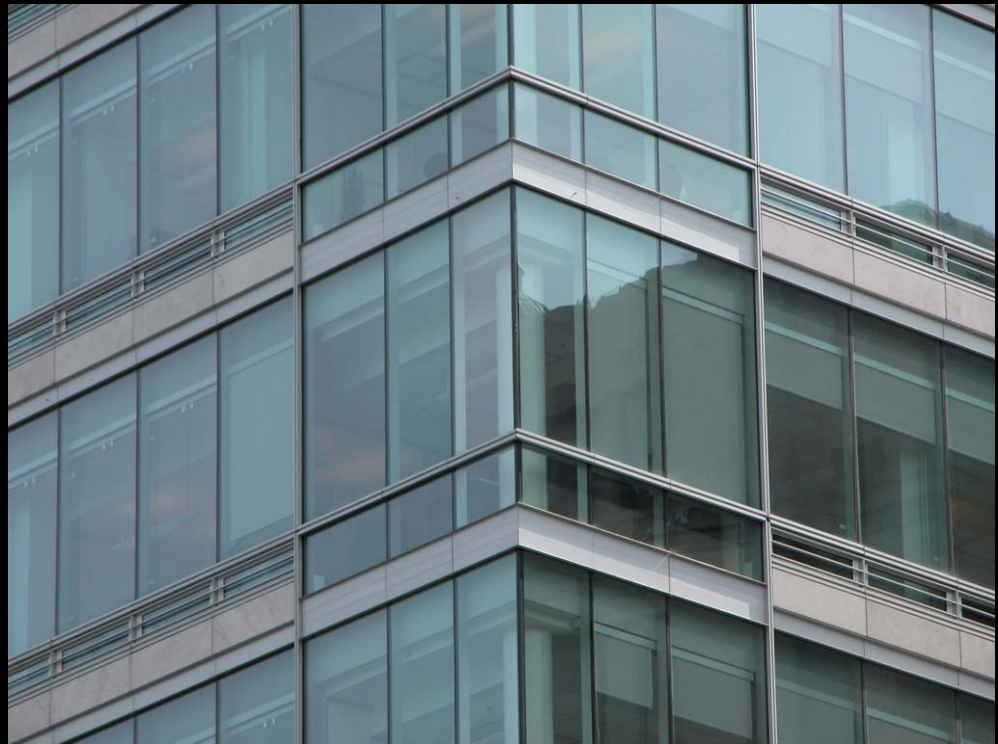

The corners of the building are treated differently as the double façade is discontinuous at this point.



(CCBR) Center for Cellular and Biomolecular Research, U of T, 2005:
Behnisch, Behnisch & Partner with Architects Alliance



The CCBR is one of the most current double façade buildings in Canada.

The majority of the proposed double façade survived design and cost cuts and was constructed

The double façade used is a **twin face** system that incorporates user controlled ventilation.

(CCBR) Center for Cellular and Biomolecular Research, U of T, 2005:
Behnisch, Behnisch & Partner with Architects Alliance



Double façade on south face and regular vented glazing on the east face.

CCBR, University of Toronto, 2005:
Behnisch, Behnisch & Partner with Architects Alliance

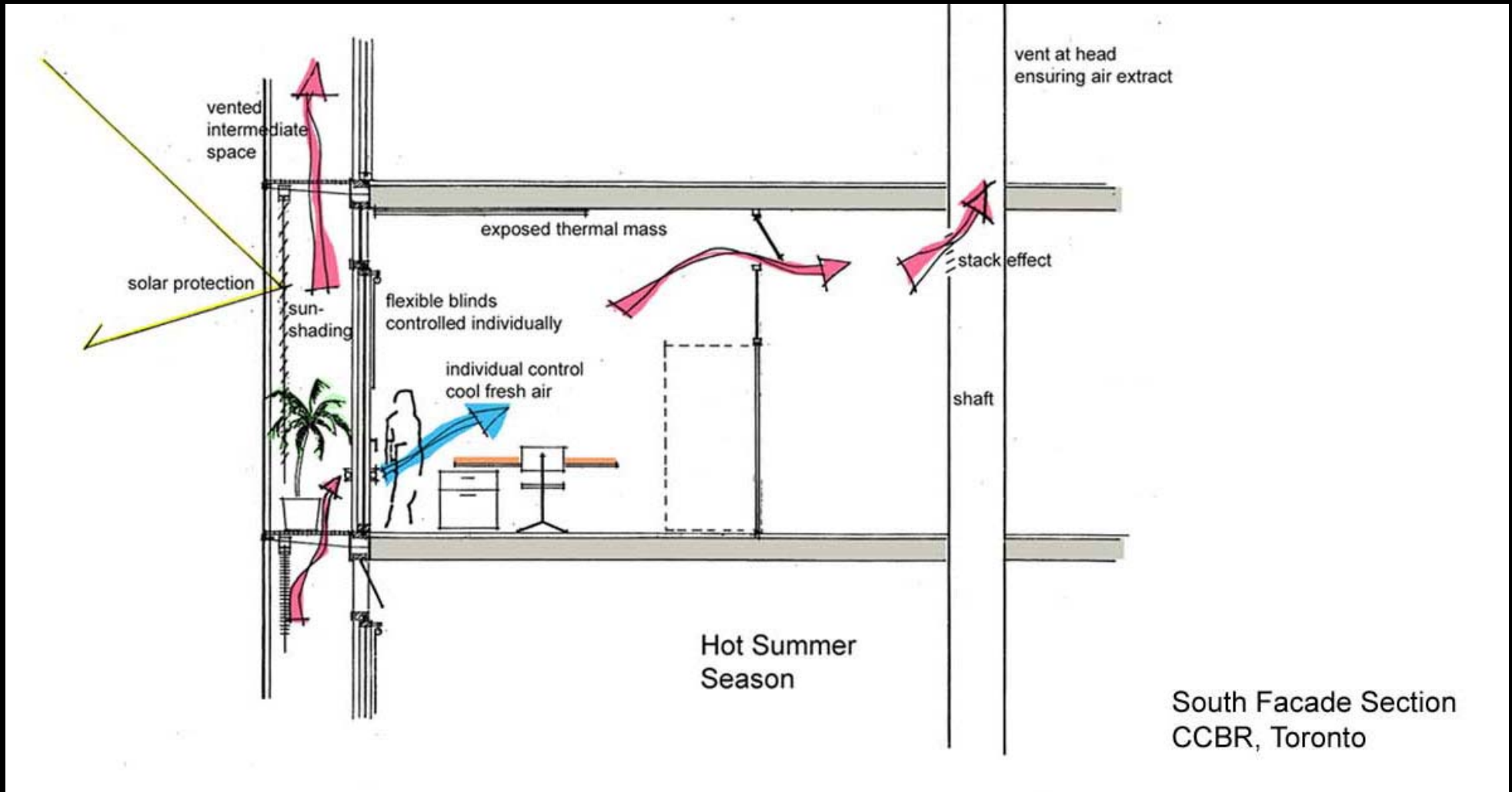

Hot summer season

Shades in cavity protected from weather

CCBR, University of Toronto:
Behnisch, Behnisch & Partner with Architects Alliance

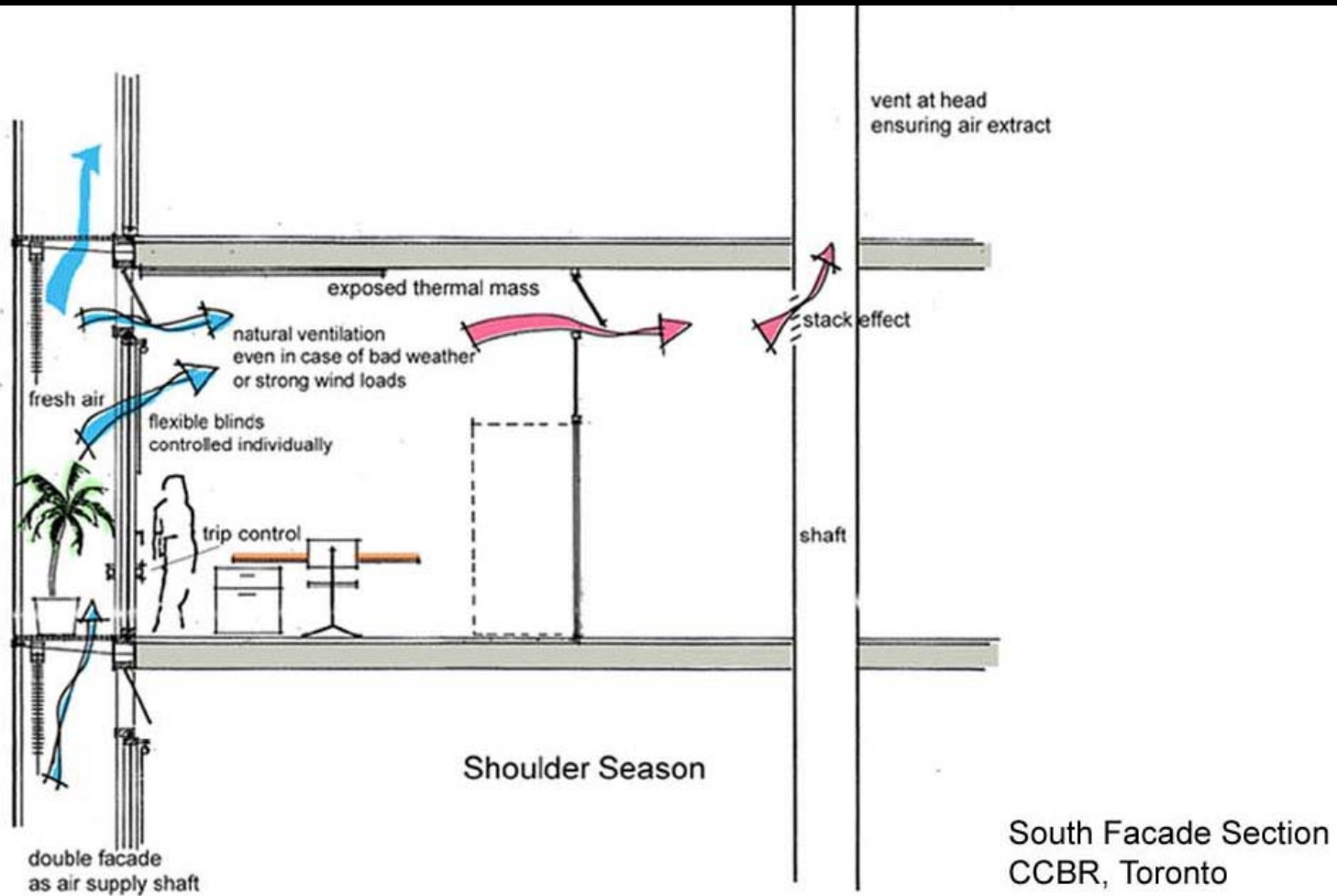

Shoulder season

Plants were NOT put in cavity. Not the place for them.

CCBR, University of Toronto:
Behnisch, Behnisch & Partner with Architects Alliance

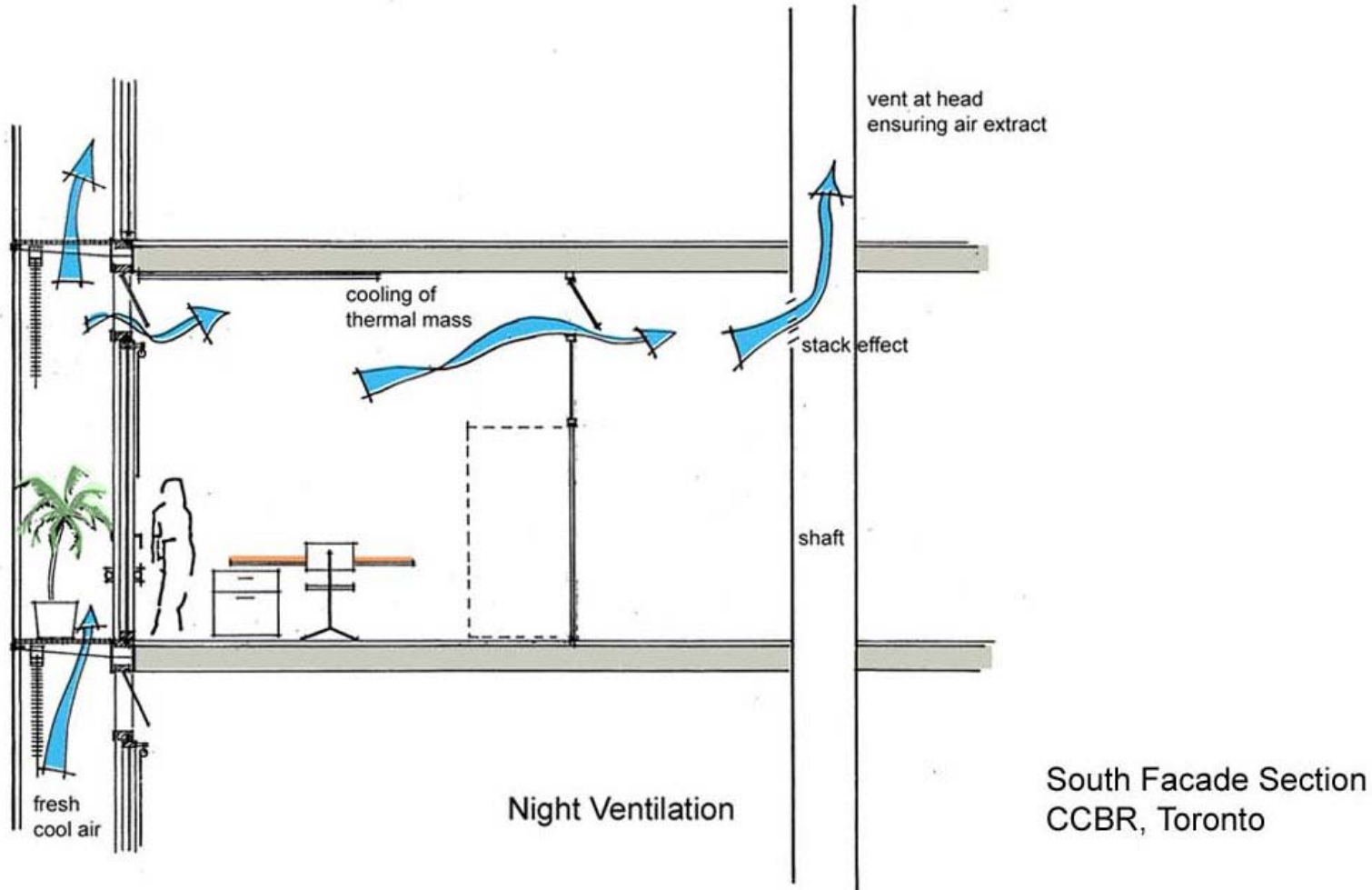

Night Ventilation

CCBR, University of Toronto: Behnisch, Behnisch & Partner with Architects Alliance

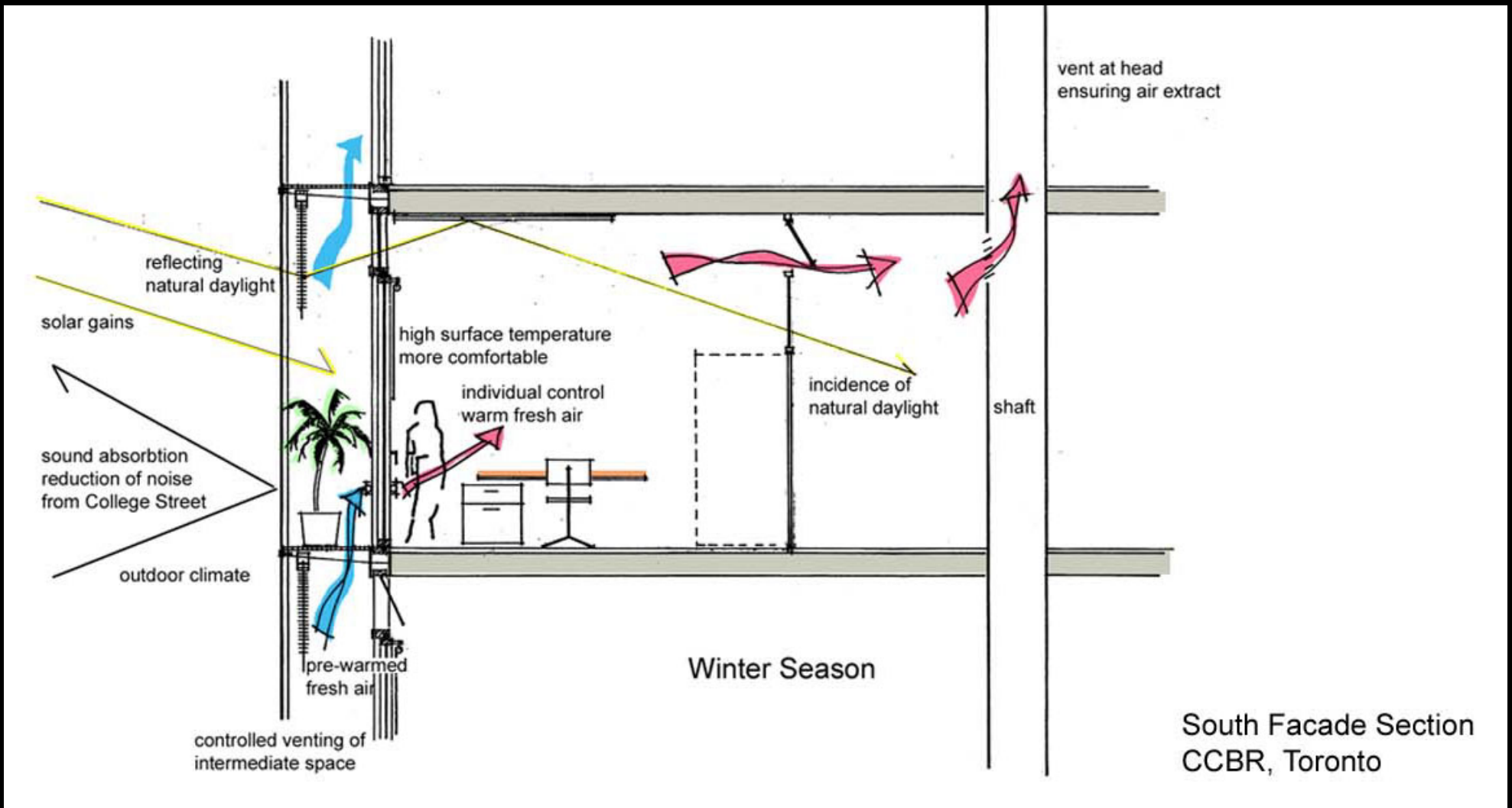

Winter season

CCBR, University of Toronto:



The double skin is situated on the south side only. These shots show the inner façade nearing completion. Operable windows from the individual offices can be seen, as well as air intake grilles that align with the ceiling plenum



CCBR, University of Toronto:

Double height atrium spaces that are planted with trees occur at various edge conditions along the south façade and are NOT included in the double skin layer.



CCBR, University of Toronto:

The outer skin is installed very “elementally”, piece by piece, and its outermost dimension is in line with the formerly protruding corner atria.



CCBR, University of Toronto:



A construction worker wiring the double skin space prior to installation of the outer glazing layer. Private offices are primarily situated behind the double façade.

The east façade is single glazed and also includes operable windows into the labs.





Intersection of the upper west atrium and the double façade.



Solar shades in the cavity.



The upper west corner atrium.

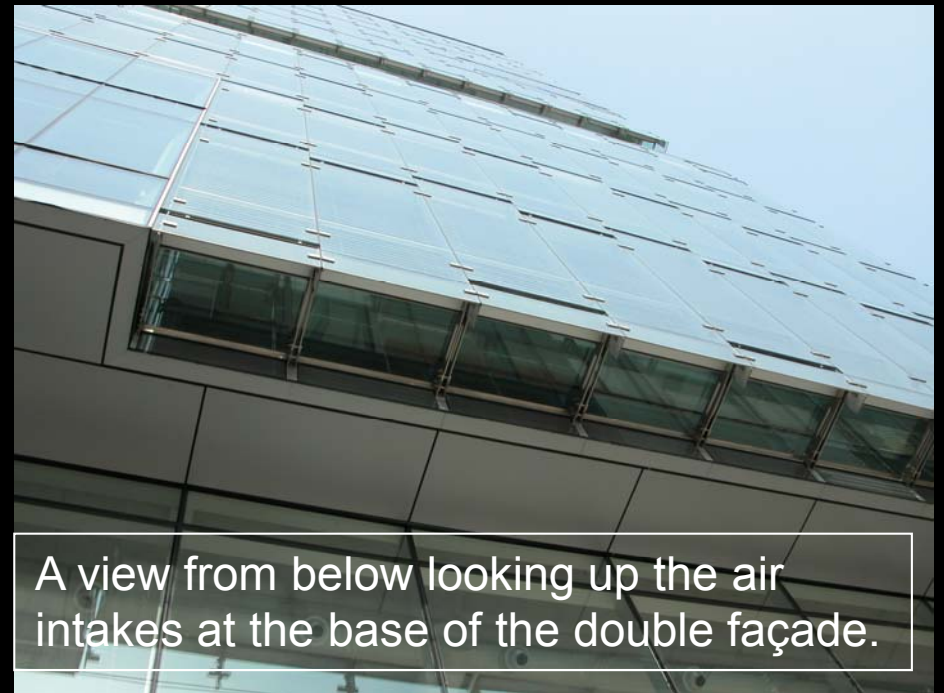

A view from below looking up the air intakes at the base of the double façade.



Looking into a finished office and eastward from one of the corner atria, along and through the dimension of the south facing double façade.



Commerzbank,
Frankfurt Germany
1997
Foster + Partners

Commerzbank was the result of an international design competition and might be credited with initiating interest in both double façade buildings as well as more environmentally sustainable skyscrapers.



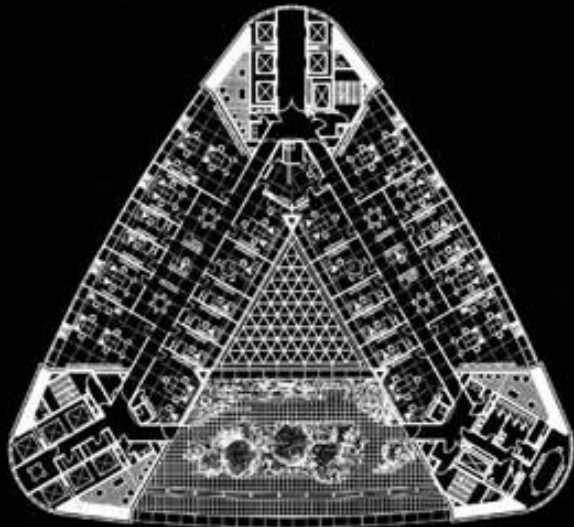

The triangular shaped building has an atrium in the centre with “gardens” and a double façade skin. Central is a reliance on natural systems of lighting and ventilation. Every office in the tower is daylit and has openable windows. External conditions permitting, this allows occupants to control their own environment for most of the year. This strategy results in energy consumption levels equivalent to half those of conventional office towers.

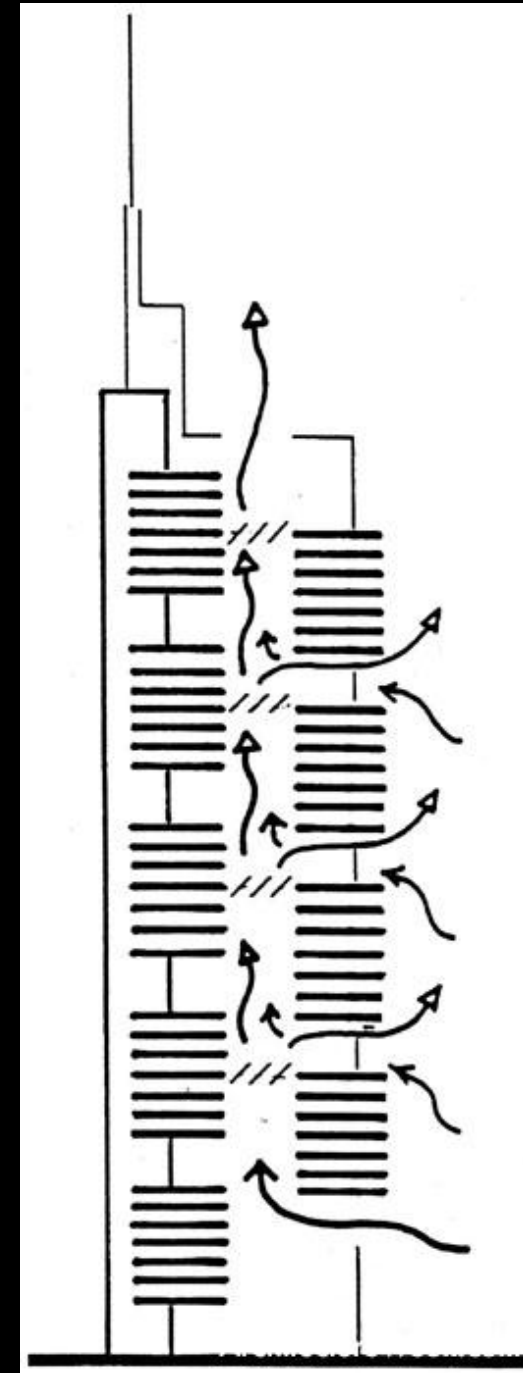
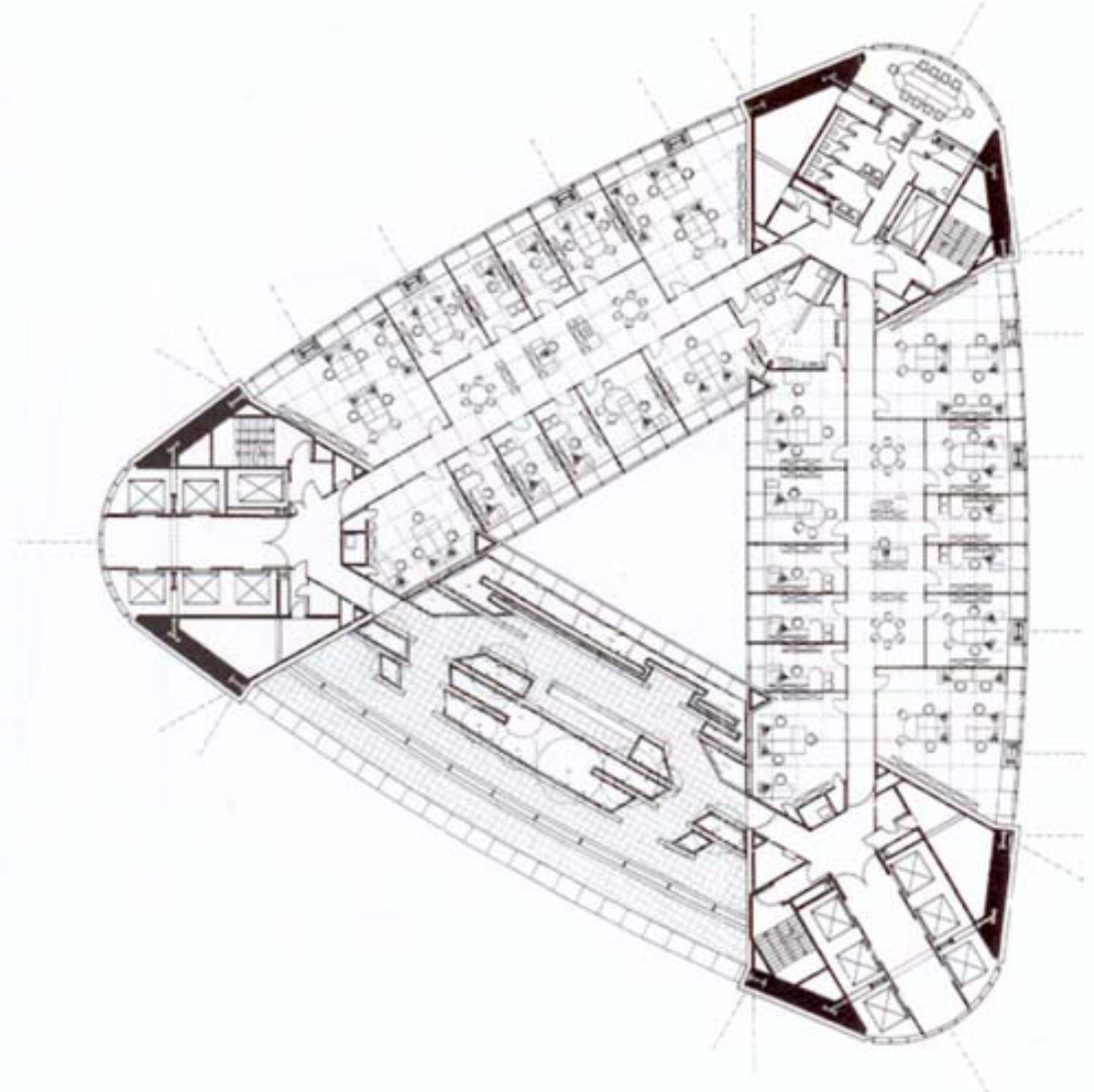

Figure 99

View of Commerzbank headquarters (model) in urban environment and typical floor plan



The plan form is triangular, comprising three 'petals', the office floors and a 'stem' formed by a full-height central atrium. Pairs of vertical masts enclose services and circulation cores in the corners of the plan and support eight-storey Vierendeel beams, which in turn support clear-span office floors.

Four-storey gardens are set at different levels on each of the three sides of the tower, forming a spiral of gardens around the building. As a result only two sides of the tower are filled with offices on any level. The gardens become the visual and social focus for village-like clusters of offices. They play an ecological role, bringing daylight and fresh air into the central atrium, which acts as a natural ventilation chimney up the building for the inward-facing offices.

The gardens are also places to relax during refreshment breaks, bringing richness and humanity to the workplace, and they give the building a sense of transparency and lightness from the outside. Depending on their orientation, planting is from one of three regions: North America, Asia or the Mediterranean.



Figure 95.3

Cross section of building
with winter gardens
(draft)

Cross section and detail

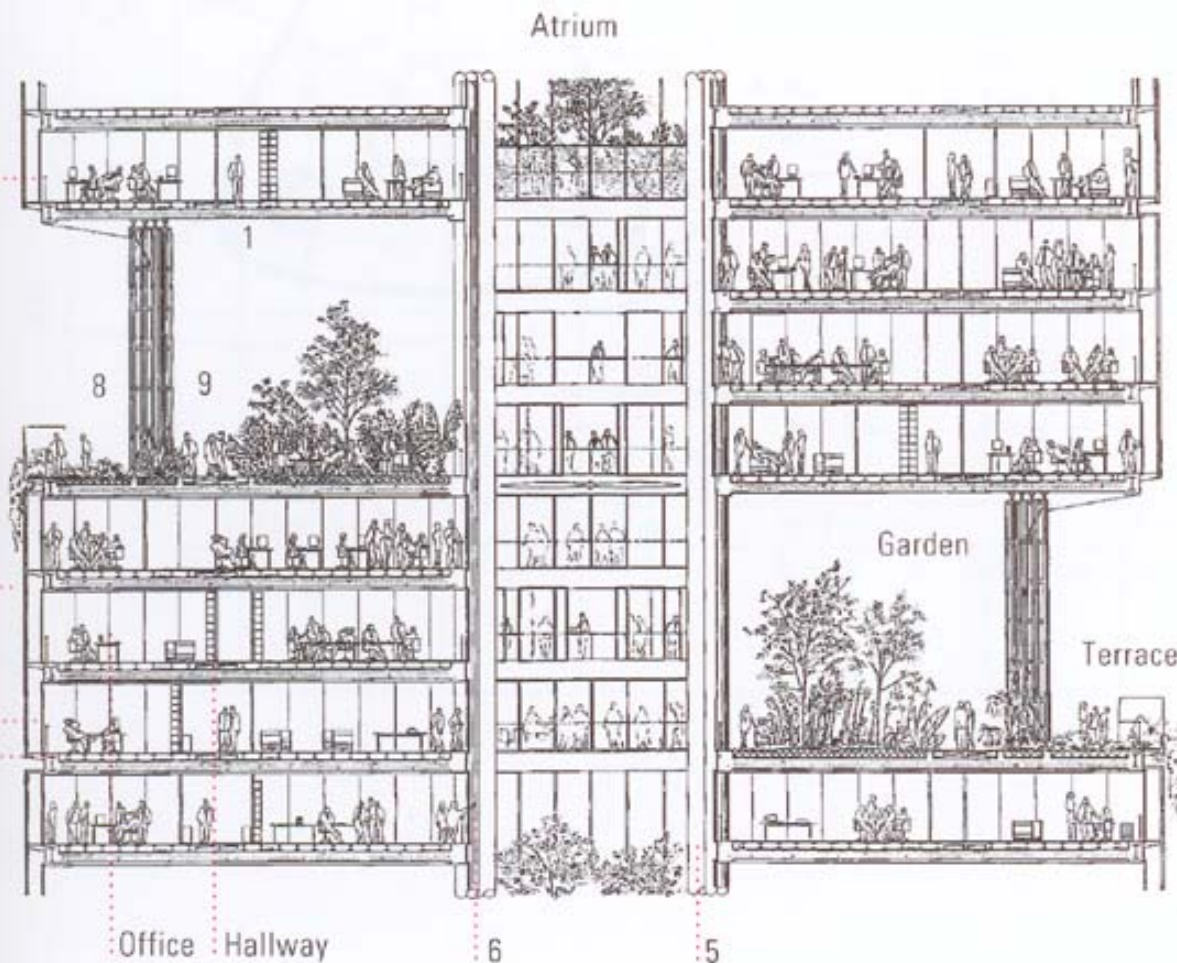

- 1 pre-stressed concrete ceiling with integrated air ducts
- 2 adjustable sun protection
- 3 single glazing
- 4 double-glazed, floor to ceiling sliding doors
- 5 atrium glazing, floor to ceiling sliding doors
- 6 glazed ballustrade
- 7 girders
- 8 double glazing with openable windows (top and bottom)
- 9 'Vierendeel' (quadrilateral) girder

Figure 98.1
 Temperature simulations
 (24 hours) in offices
 External and room temperatures
 over the course of one day
 left column day, right column night

Summer (September 1st)
 Transitional season (May 10th)

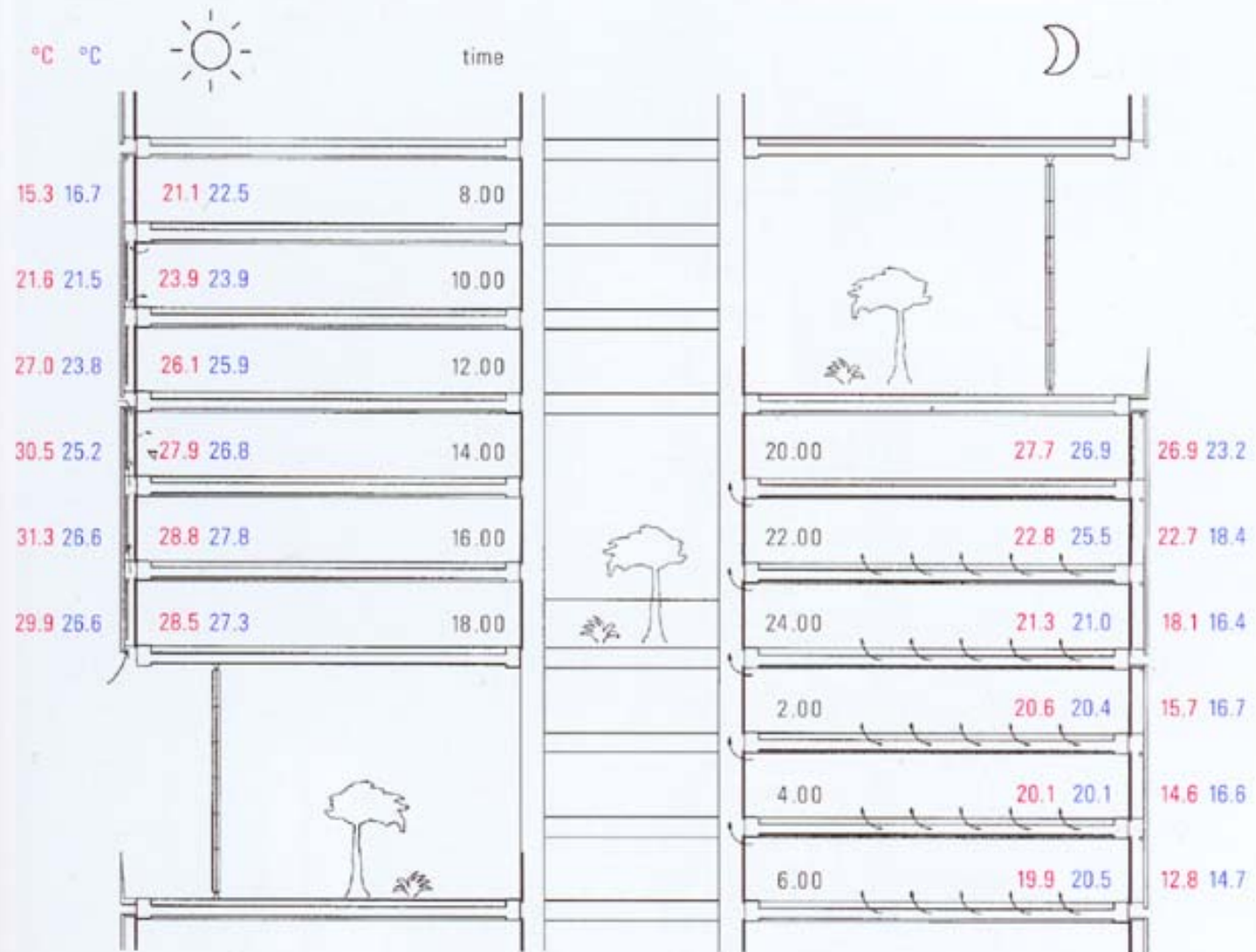



Views through central atrium



Helicon, Finsbury Pavement, Sheppard Robson, 1996:

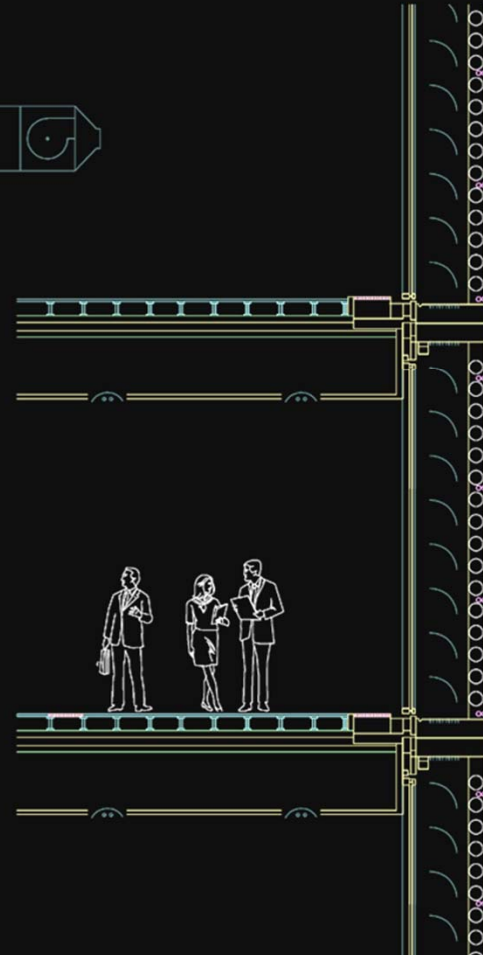

This building is an example of an **extract-air** system. No natural ventilation is provided. The cavity provides for solar control through quite orientation specialized shading provisions.

Helicon, Finsbury Pavement, Sheppard Robson, 1996:

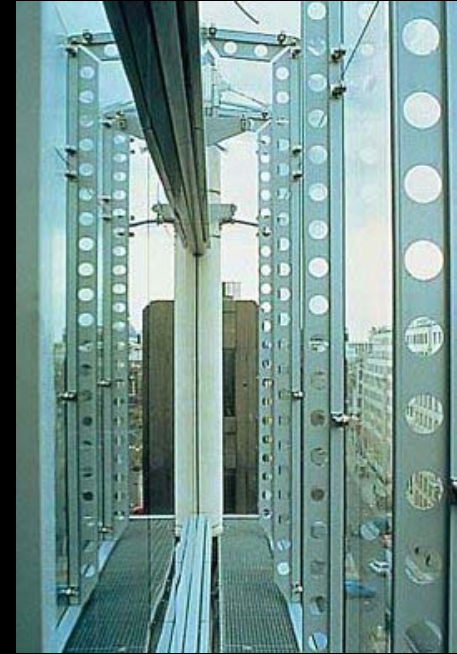

Views of the façade: the air intake from street level, looking up (right)

RWE AG, Germany, Ingenhoven Overdiek und Partner, 1997

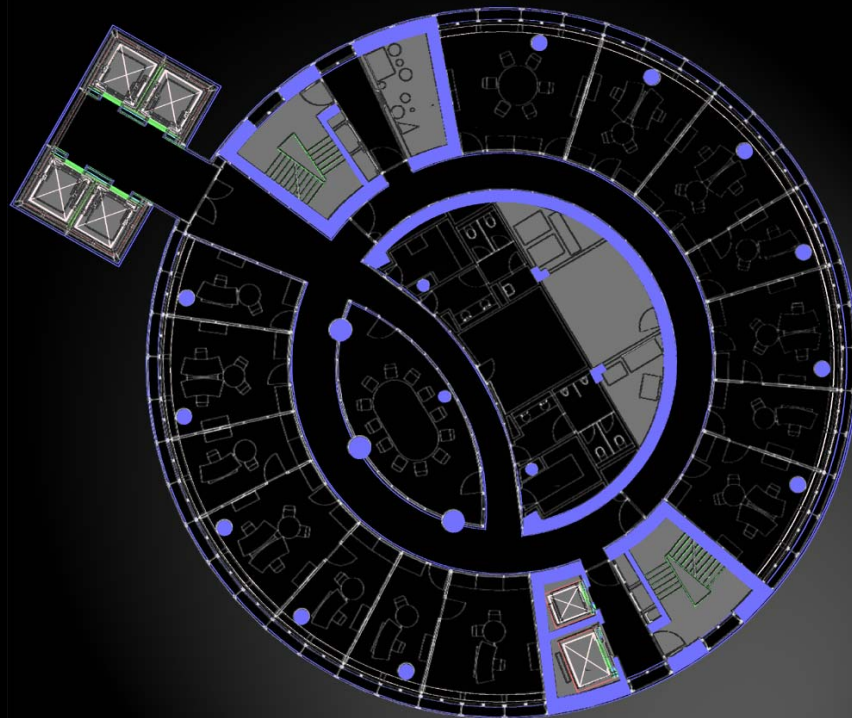

RWE is cited as one of the first high rise examples of double façade construction (Commerzbank would be the other). It uses **twin face** construction that has a divided air space. The patented “fish mouth” mullion system is used to control air flow in and out of the skin. The building is a response to German laws mandating the minimum distance between workers and daylight.

RWE AG, Germany, Ingenhoven Overdiek und Partner



The cavity in the double skin is far narrower than other examples. This is normally the case in divided air spaces. Instead of cleaning the cavity from within (hence the normal 900 to 1200 mm size), RWE has its interior skin operable for cleaning purposes.

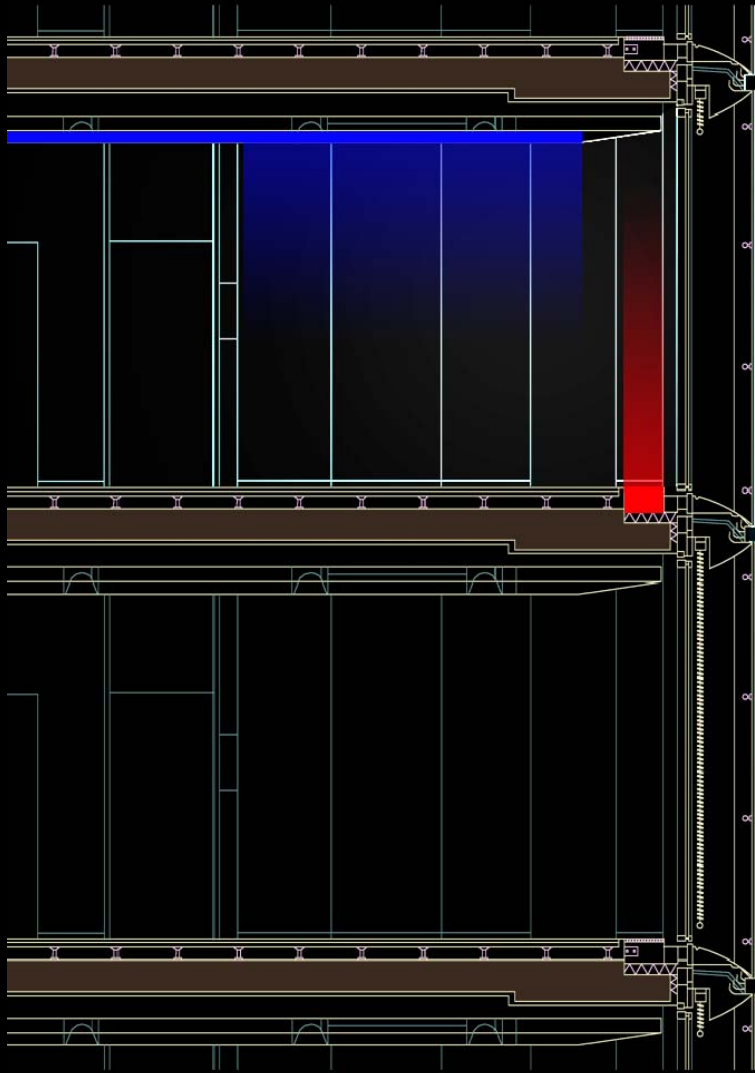

Wall Section

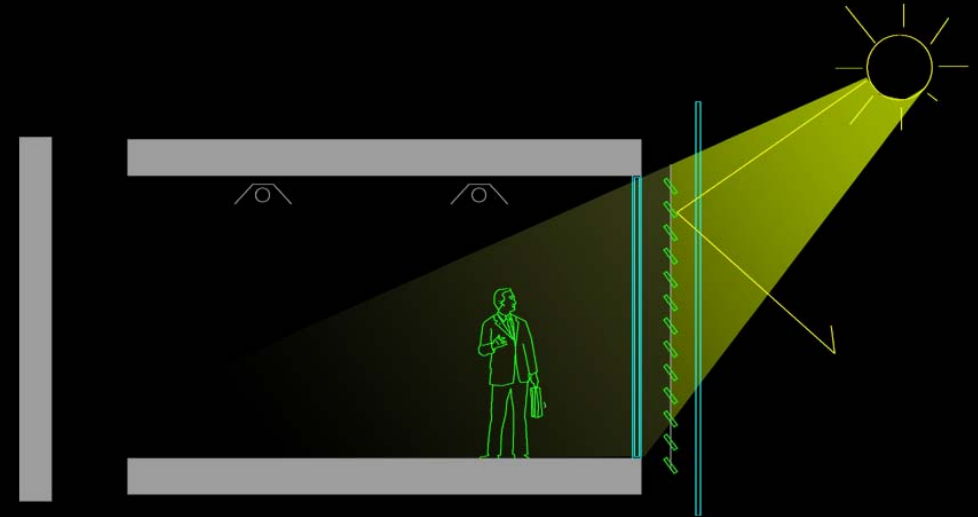

Passive Strategies

- Exposed thermal mass
- Height; allows higher temperature differential between supply and exhaust
- Solar controlling glazing
- Good solar shading
- Low level artificial lighting; link to daylight levels

Potsdamer Platz 1, Berlin (centre building)
Architect: Hans Kollhoff



Box façade type

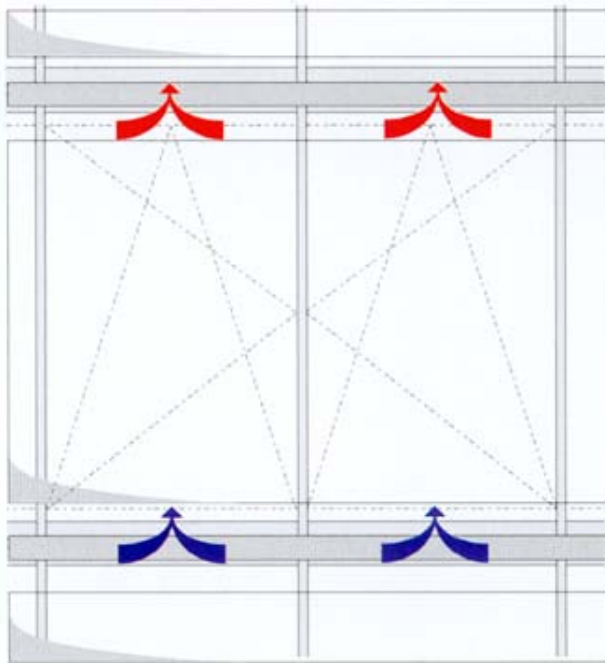

1.2 Elevation of box-window facade. The divisions between each bay mean that an opening light is also required for each bay.

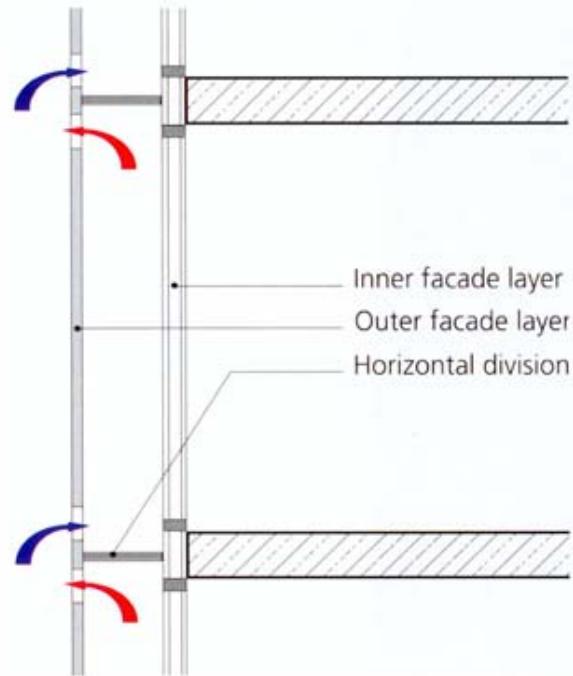

1.3 Section through typical box-window facade with separate ventilation for each bay.

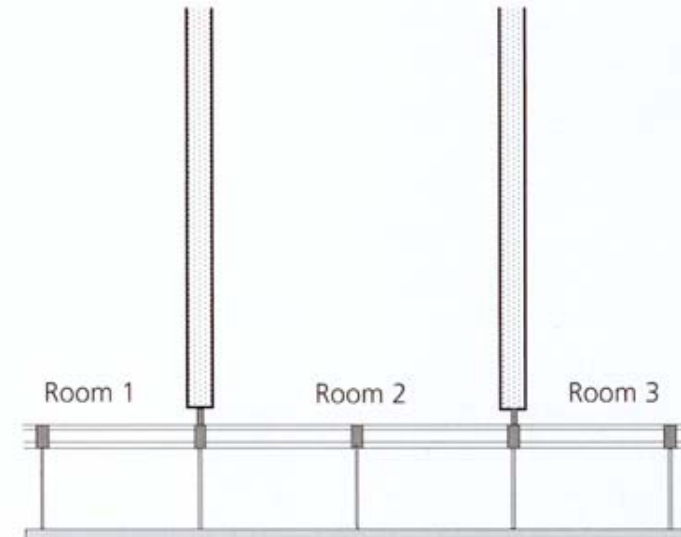

1.4 Plan of box-window facade. The divisions of the facade intermediate space are set on the construction axes.

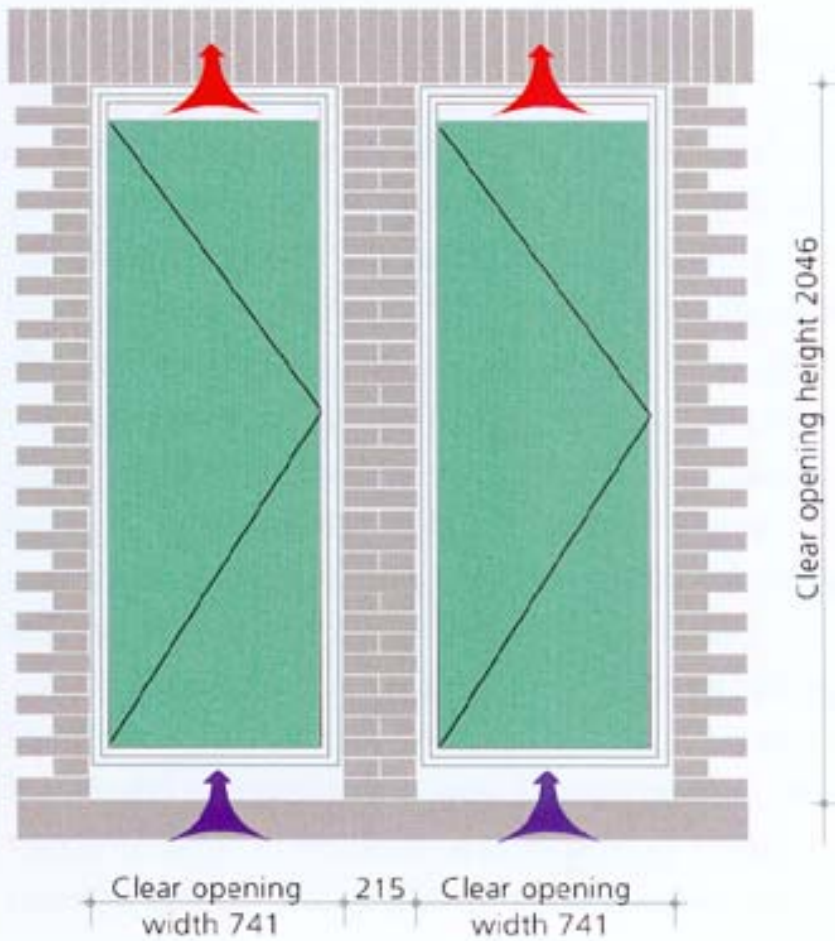

1.7 Potsdamer Platz 1:
diagrammatic section through
and elevation of box window,
showing route of airstream.

External pane in
toughened safety glass,
vertically sliding:
upper ventilation slit
closed in winter

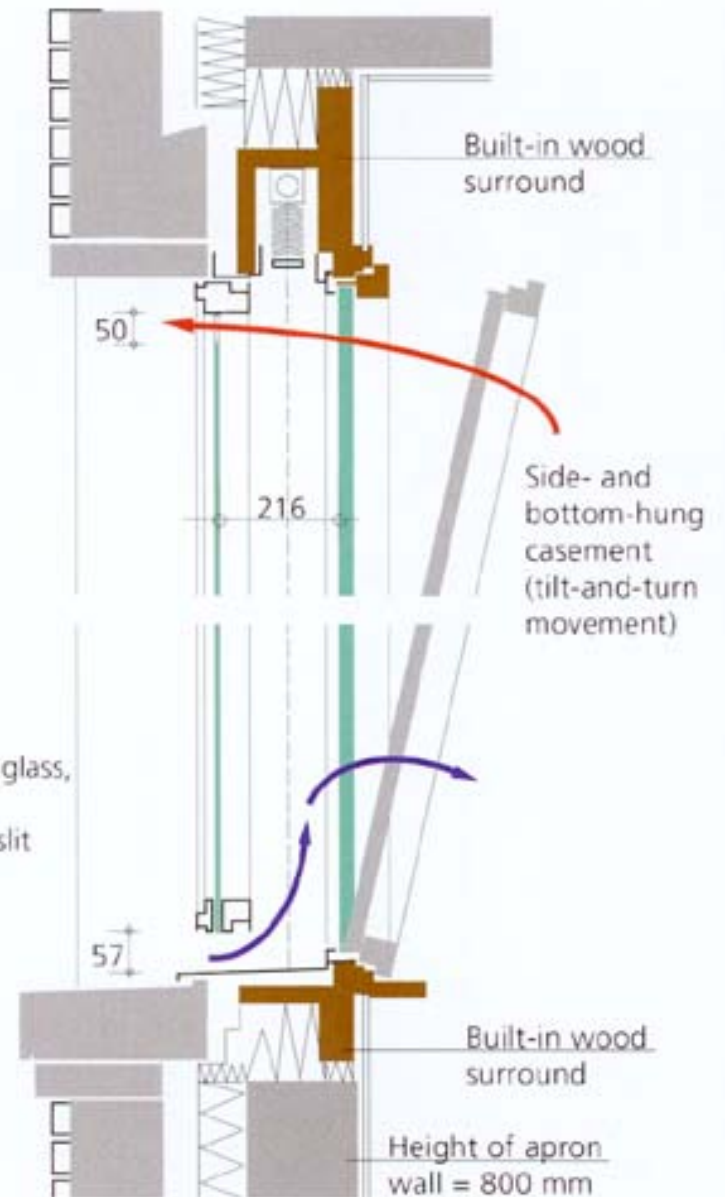

Some issues with TALL inward tilt windows include user “fear” that sometimes precludes their use.



ARAG 2000 Tower, Dusseldorf

- RKW Architects in collaboration with Norman Foster
- uses a **shaft-box façade** type of double skin
- based on twin face concepts
- alternation of box windows with vertical shafts



Shaft-box façade type

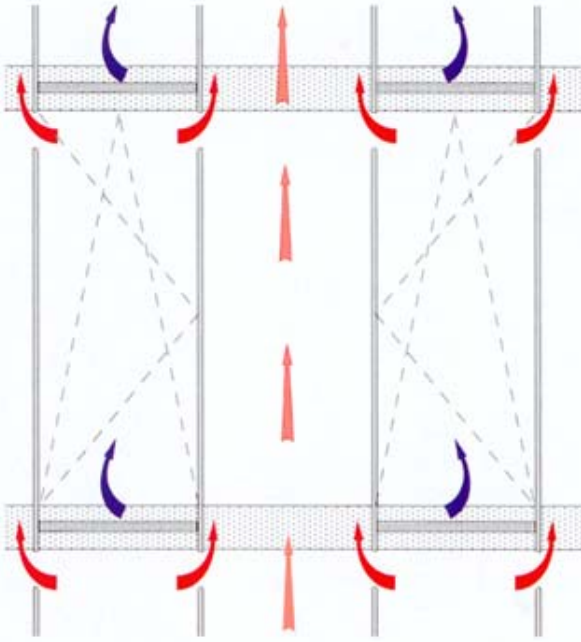

1.8 Elevation of a shaft-box facade. The arrows indicate the route of the airstream.

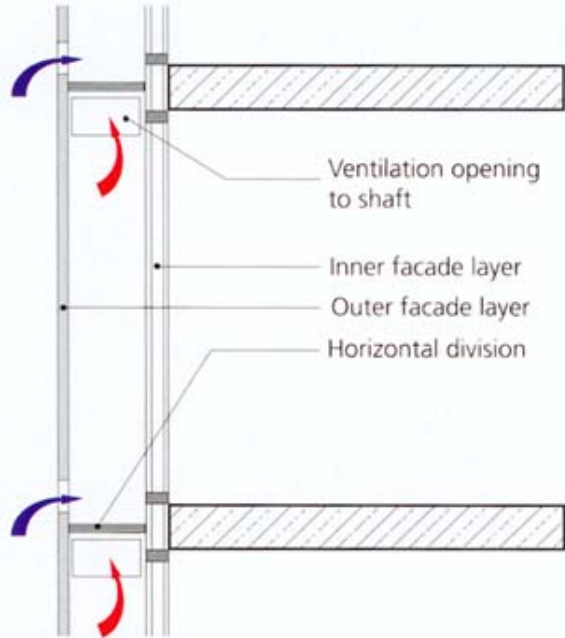

1.9 Section through a shaft-box facade. The arrows indicate the route of the airstream flowing through the box windows into the common ventilation shaft.

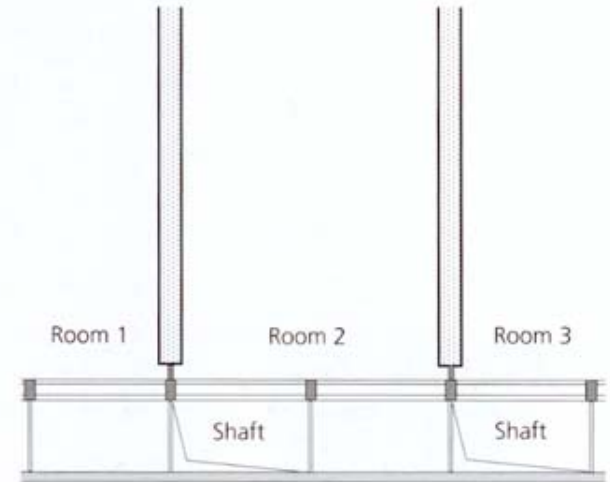

1.10 Plan of a shaft-box facade. There are side openings in the shaft divisions in the facade intermediate space.

ARAG 2000
 section showing
 flows of fresh and
 exhaust air
 throughout the
 building section

1.12 Diagram of ventilation principle in the 8-story-high shaft-box facade sections of the ARAG 2000 building.

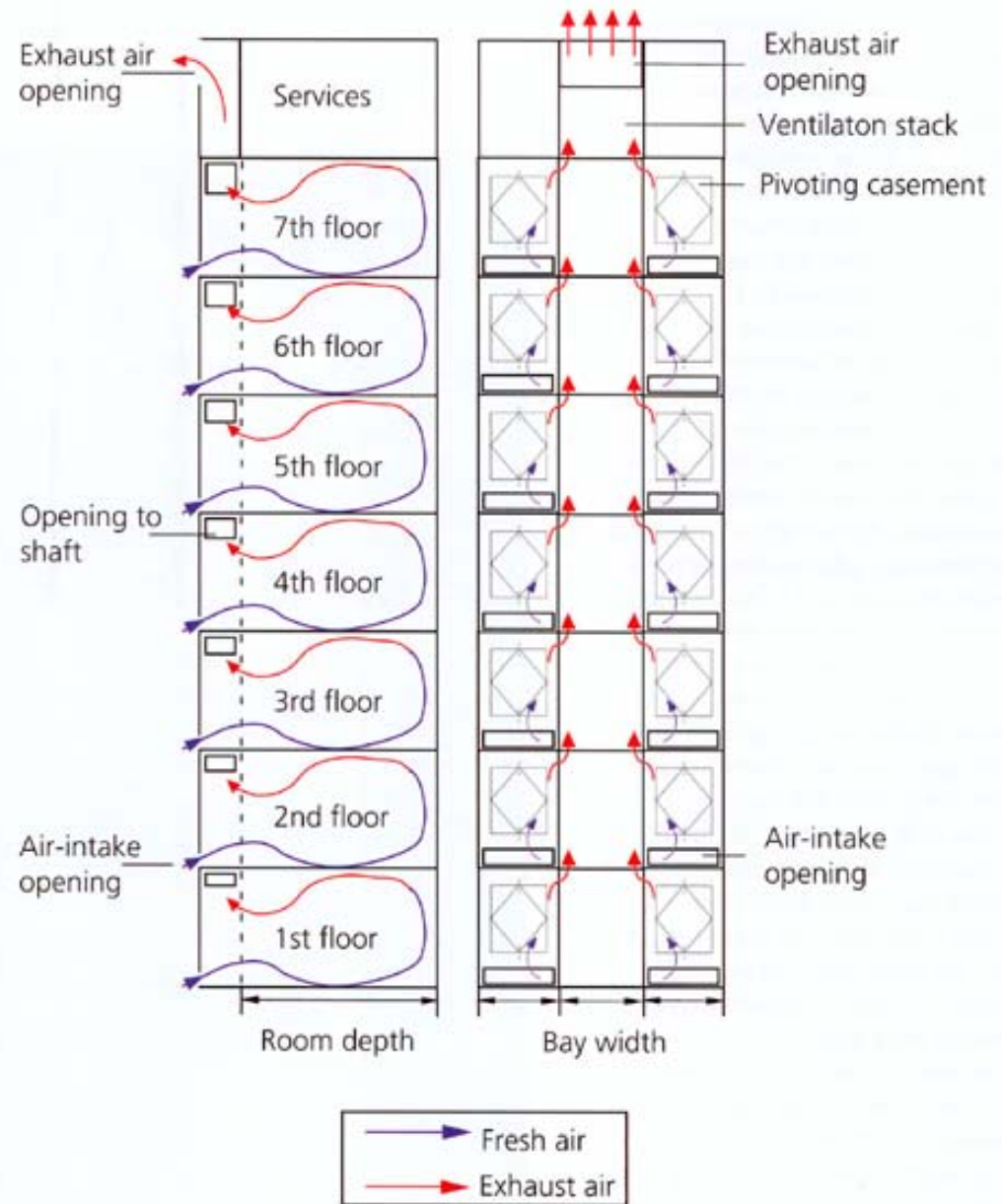



p.19

ARAG 2000: view of exterior detail

ARAG 2000: view of interior of double skin shaft-fox façade system

Note that the cavity is of adequate size that it can be entered for cleaning.



City-Gate, Dusseldorf
Architects: Karl-Heinz
Petzinka at Ingenhoven,
Overdied, Petzinka, Partner
1998
corridor façade type



Corridor façade type

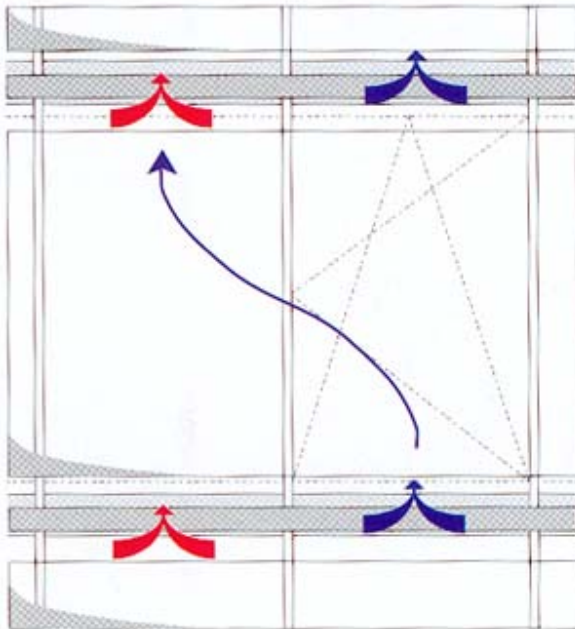

1.15 Elevation of corridor facade. Air flows on the diagonal to prevent vitiated air from the lower story being sucked in with the air supply of the floor above (recontamination).

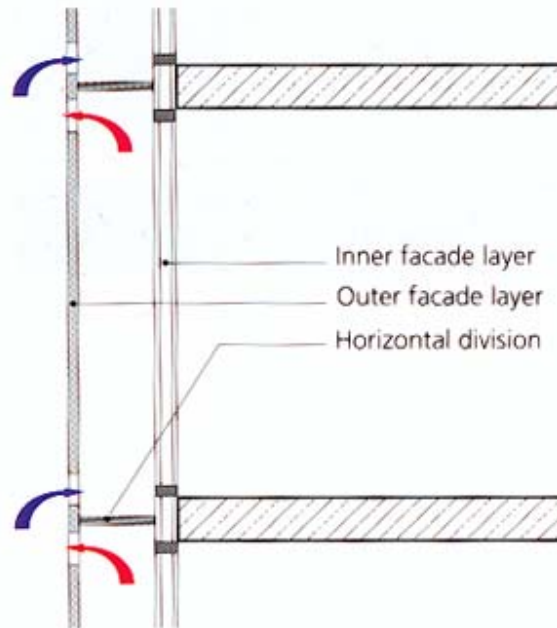

1.16 Section through a corridor facade. Separate circulation for each story.

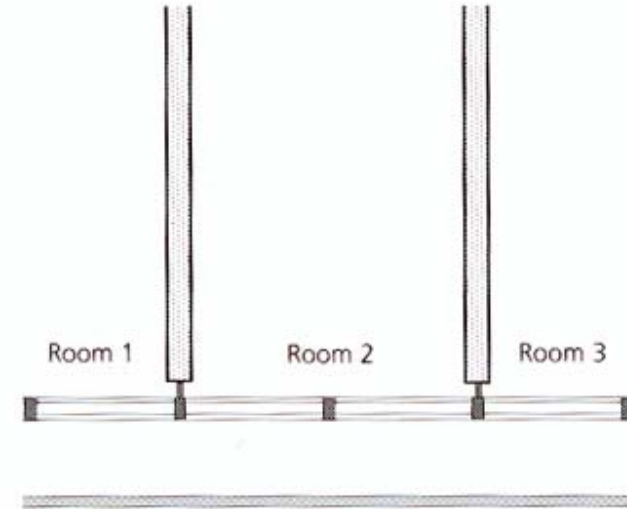

1.17 Plan of a corridor facade. The intermediate space is not divided at regular intervals along its horizontal length.

1.19 Section through and elevation of the corridor facade, "City Gate", Düsseldorf. A uniform "ventilation box" was used for all air-intake and extract elements.

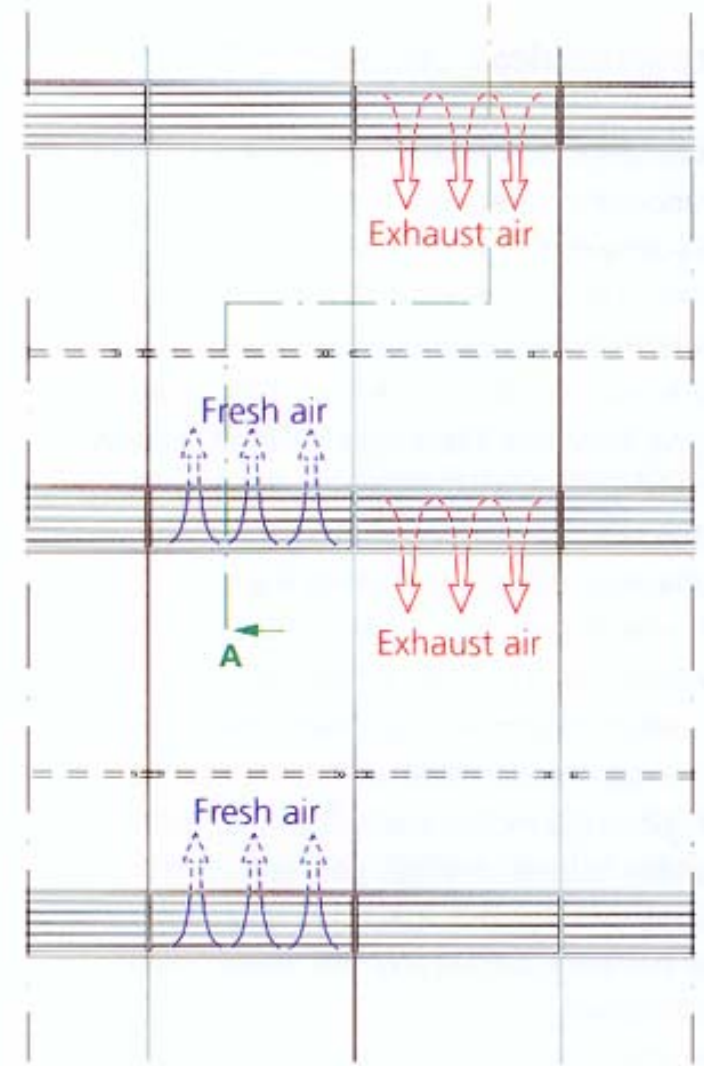
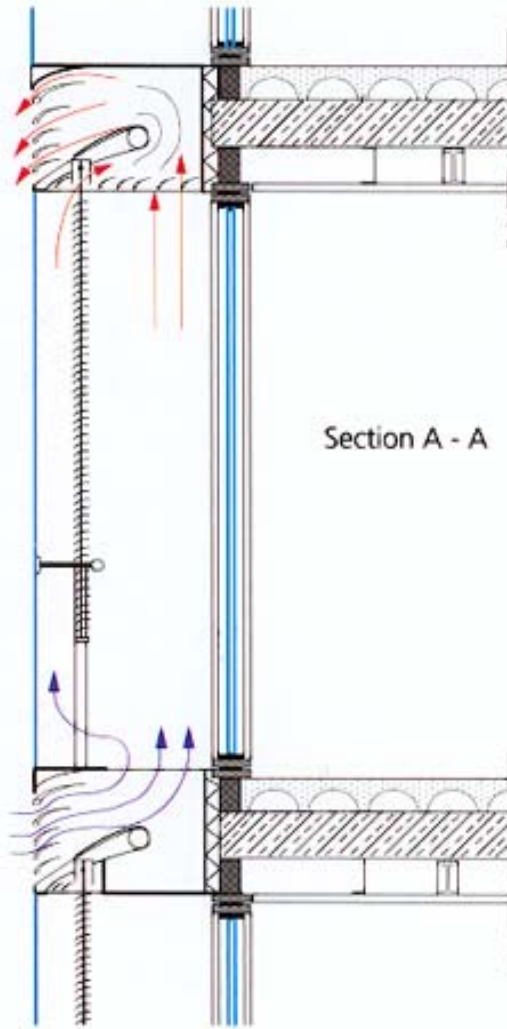

City-Gate: view of corridor
façade around exterior



Victoria Ensemble,
Cologne, Germany
“conical building”
Architect: Thomas van
den Valentyn
1996

multi-storey façade



Multi-storey façade type

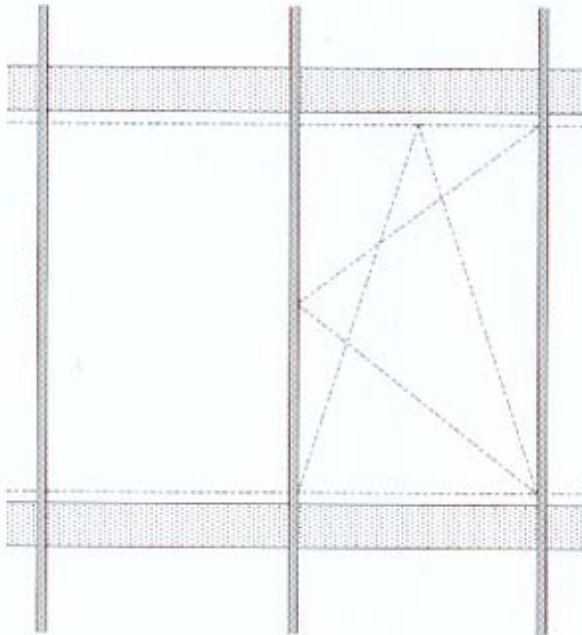

1.21 Elevation of part of a multi-story facade. The arrangement of the casement opening lights depends on the ventilation and cleaning concept chosen for the facade.

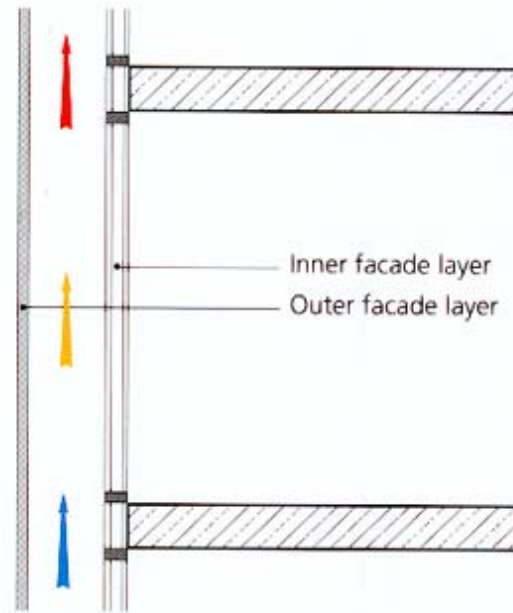

1.22 Section through a multi-story facade. The external skin is set independently in front of the inner facade. The intermediate space can be ventilated in all directions.

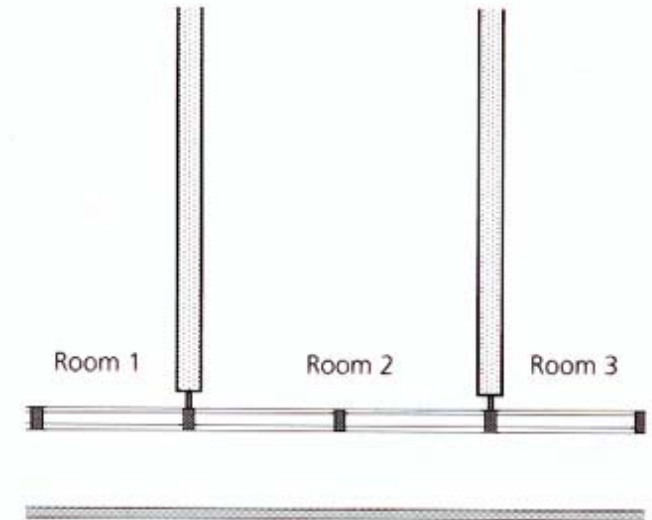

1.23 Plan of a multistory facade. The intermediate space is undivided and can be freely ventilated.

Section through the multi-storey sloped double façade along the exterior wall of the “conical building”

Note the air intake at the base and exhaust at the top of the cavity.

1.24 Section through the multistorey facade of the Victoria Ensemble, Cologne. Air streams into the intermediate space via a trench at the foot of the facade, ascends over the height of the building and is emitted at roof level.

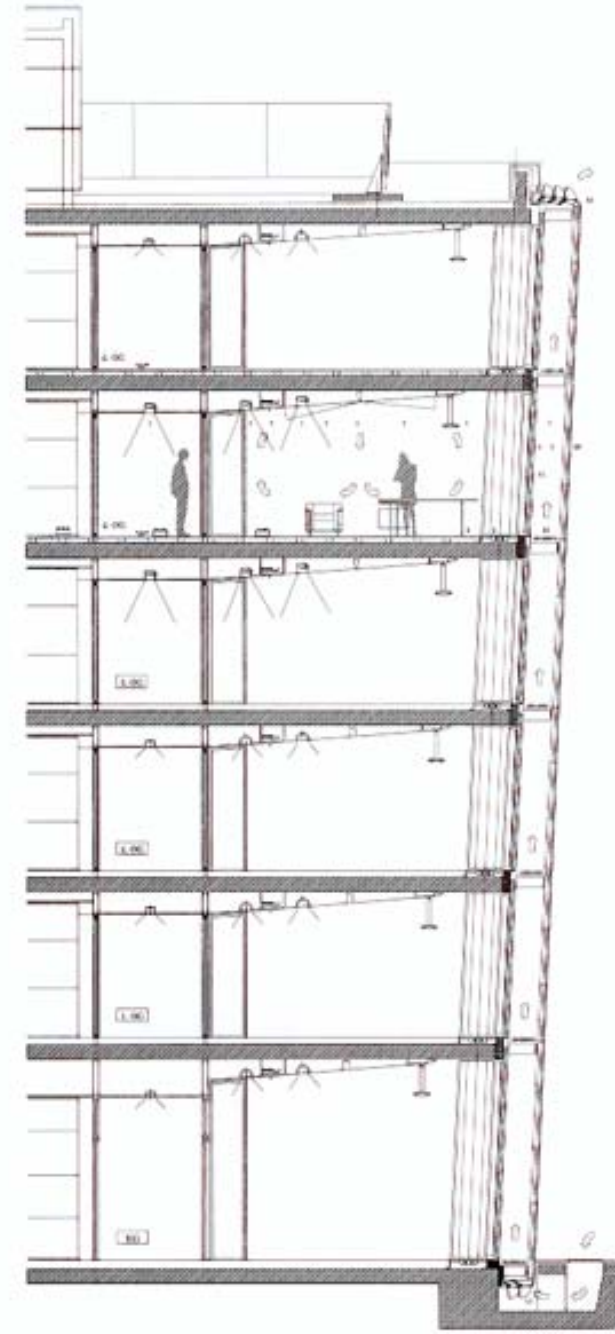

View inside air
space of
“conical
building”
façade



Business Tower,
Nuremberg
Architects: Durschinger
+ Biefang/Jorg
Spengler, 2000
134m tower
double skin façade with
permanently ventilated
cavity
unit construction
system with extremely
high level of
prefabrication



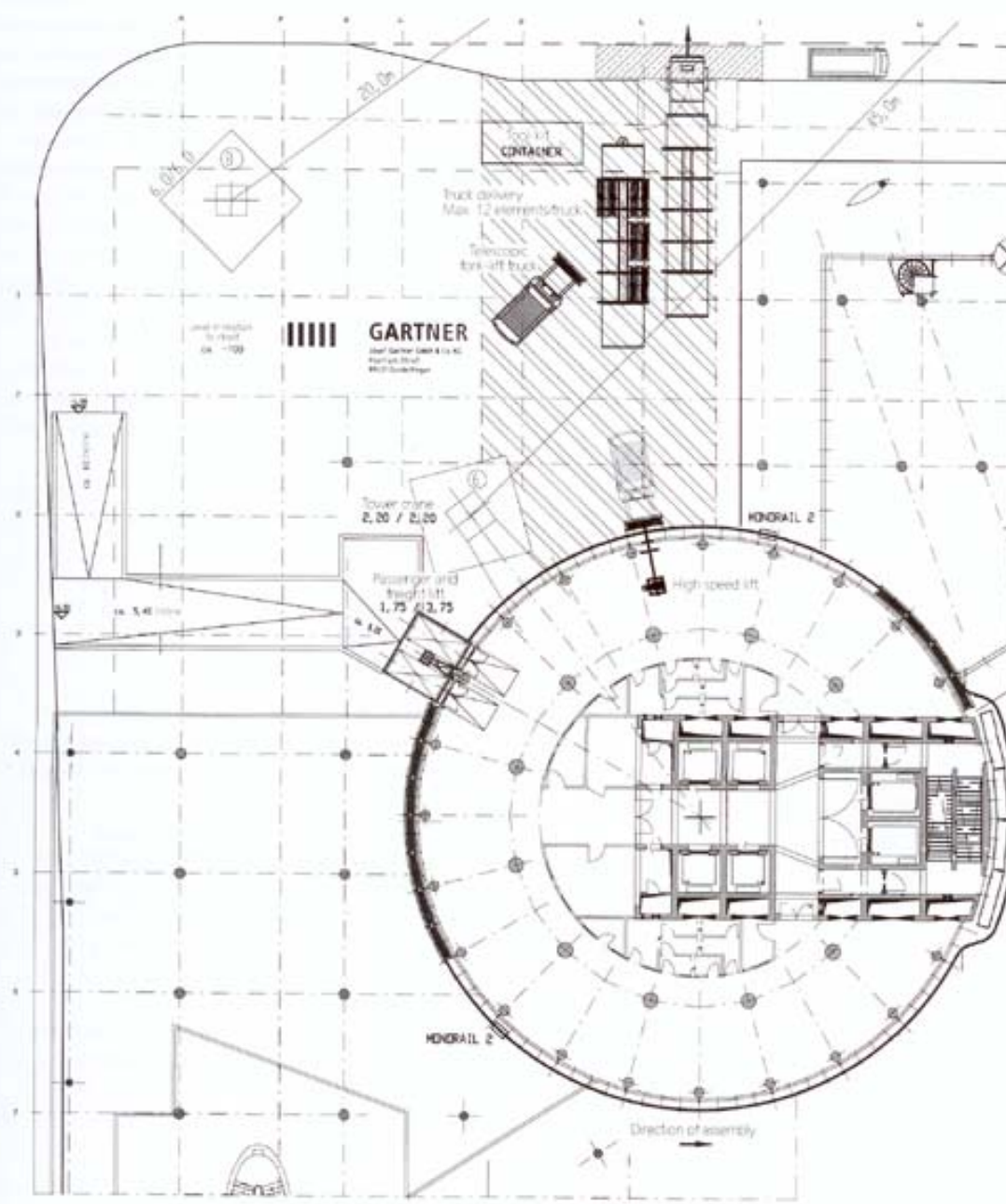

10-34 Plan of Business Tower building site, Nuremberg. The hatched area indicates the delivery zone for the facade elements.

Unlike a smaller building that can benefit via cross ventilation, the tall building must be compartmentalized to prevent cross ventilation across the interior or around the cavity.

9-6 Example of measures to achieve a windward/leeward separation by closing off compartments in the layout and in the facade: Business Tower, Nuremberg.

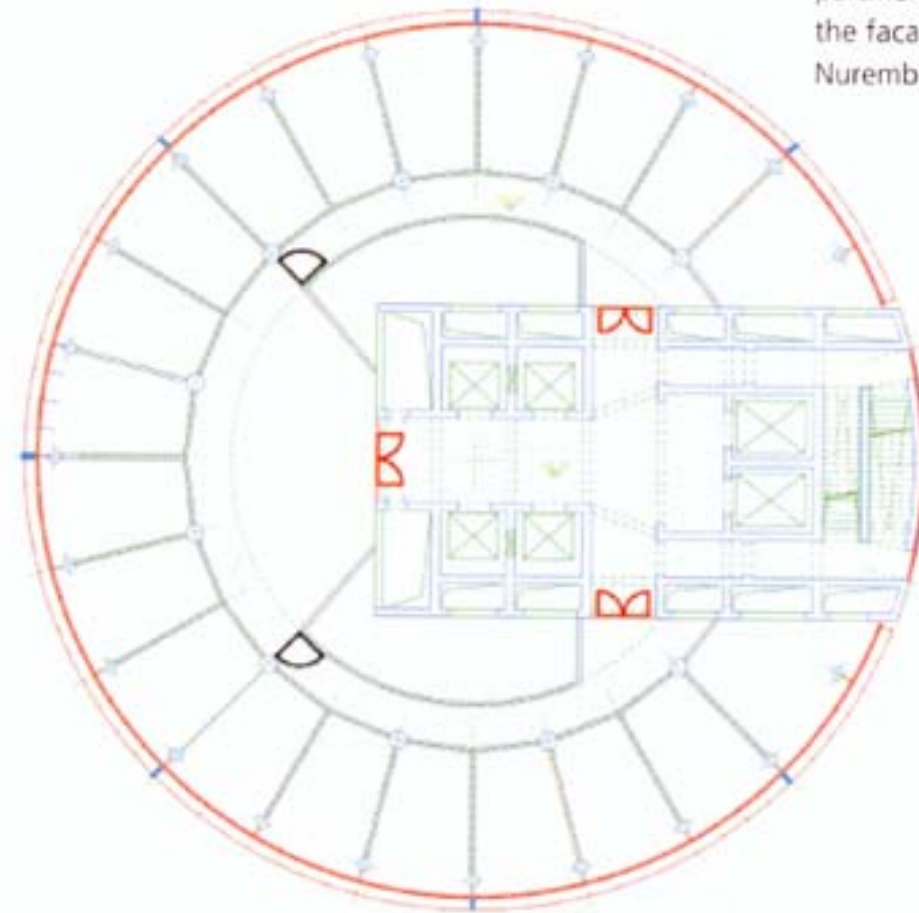

Elements of windward/leeward separation:

- Division of facade corridor into max. 45_i segments
- Division of main corridor into roughly 90_i segments
- Creation of air locks in core area

This project used a high level of prefabrication to design and erect the façade elements.

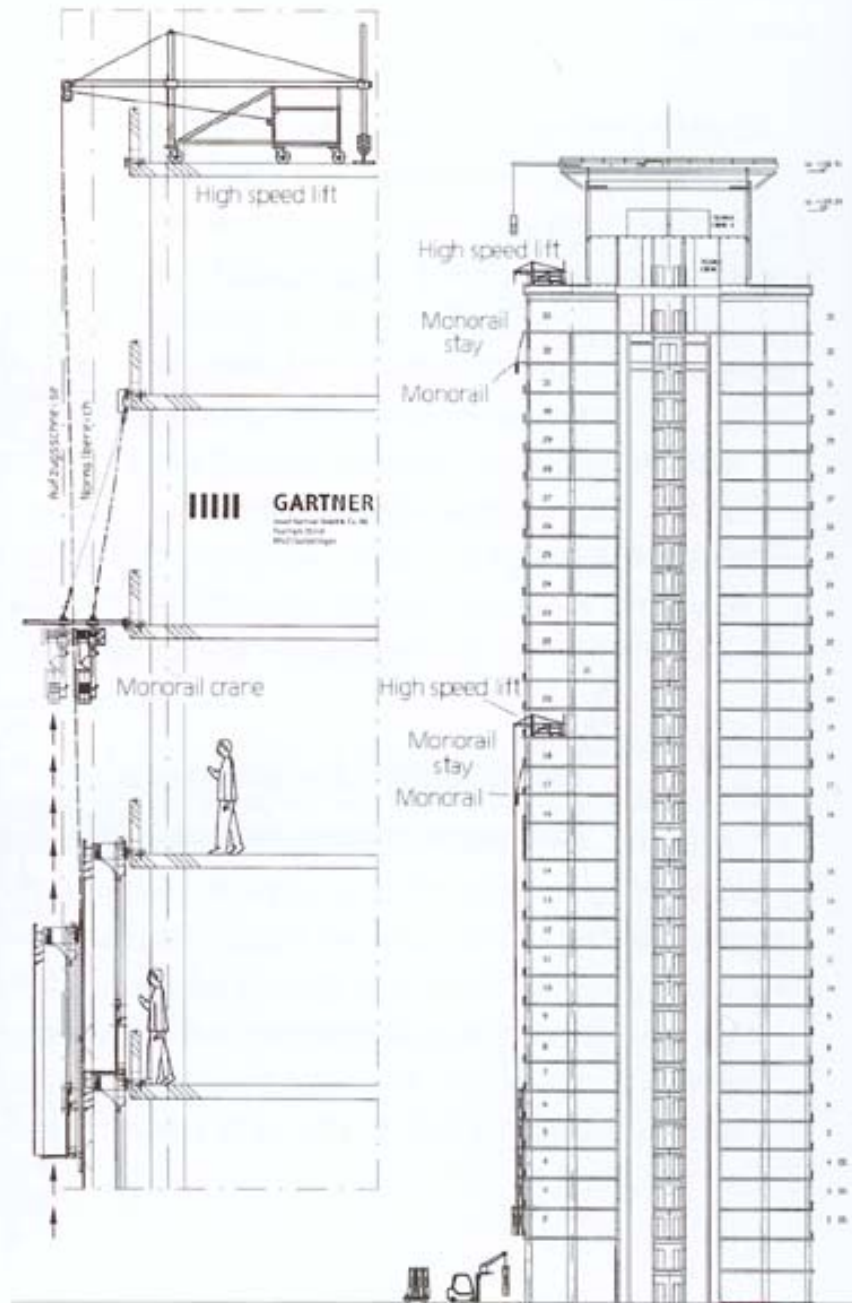

10-32 Far right: principle of lifting equipment with which the prefabricated elements are hoisted into position for assembly. Example: Business Tower, Nuremberg.

Detail of vertical section through one component. The heavy dashed lines at the floor show the start/finish/connection of one unit to the next.

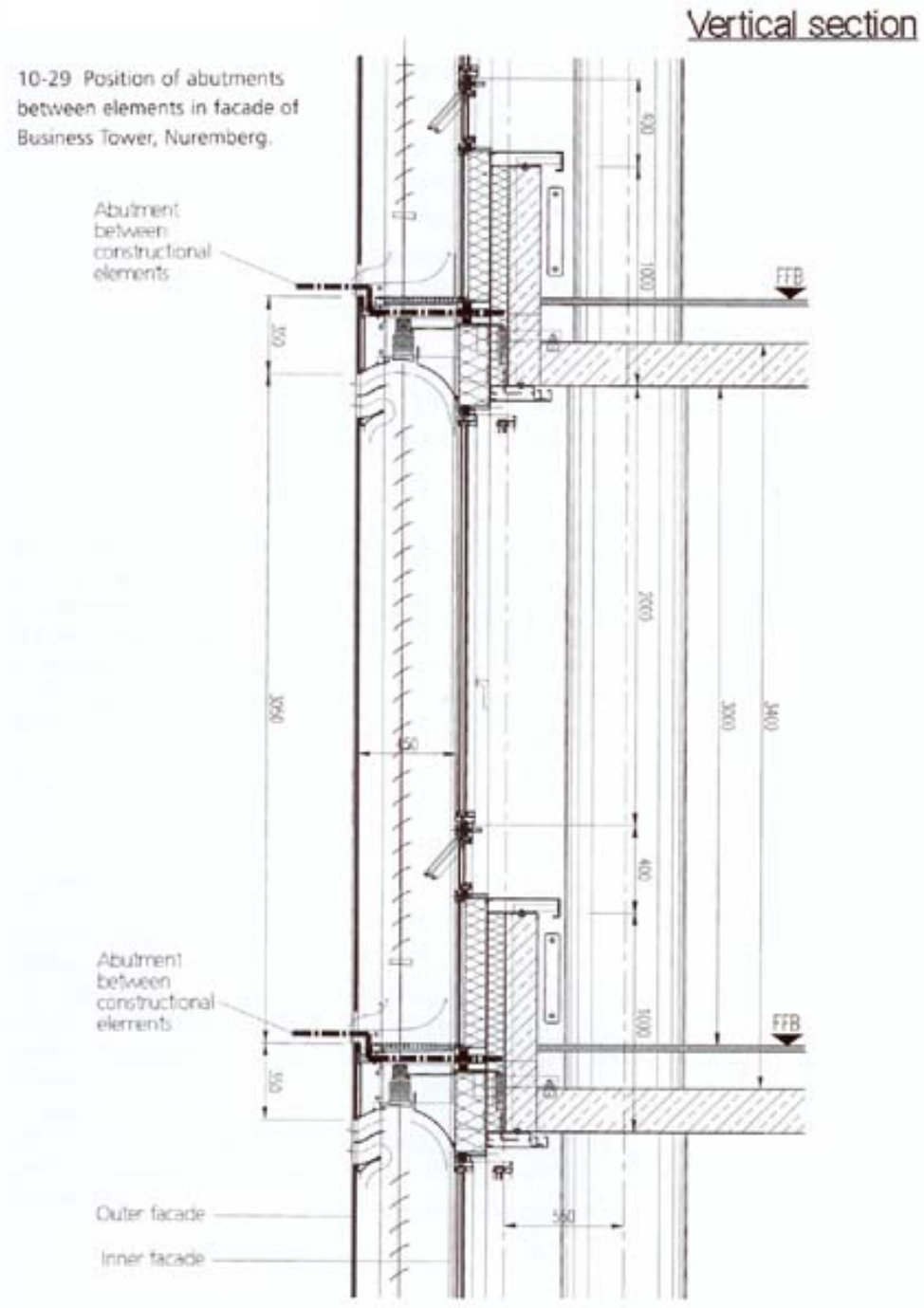



This image illustrates lifting a single element into position. The circular tower is actually segmented into a multi faceted circular plan, each component rectangular in itself.

Prefabrication is the only way to create some economy of cost and time in this type of project.

Overall view of tower, module installation in progress.



A very high degree of articulation is required in the assembly to control and direct the air flow.

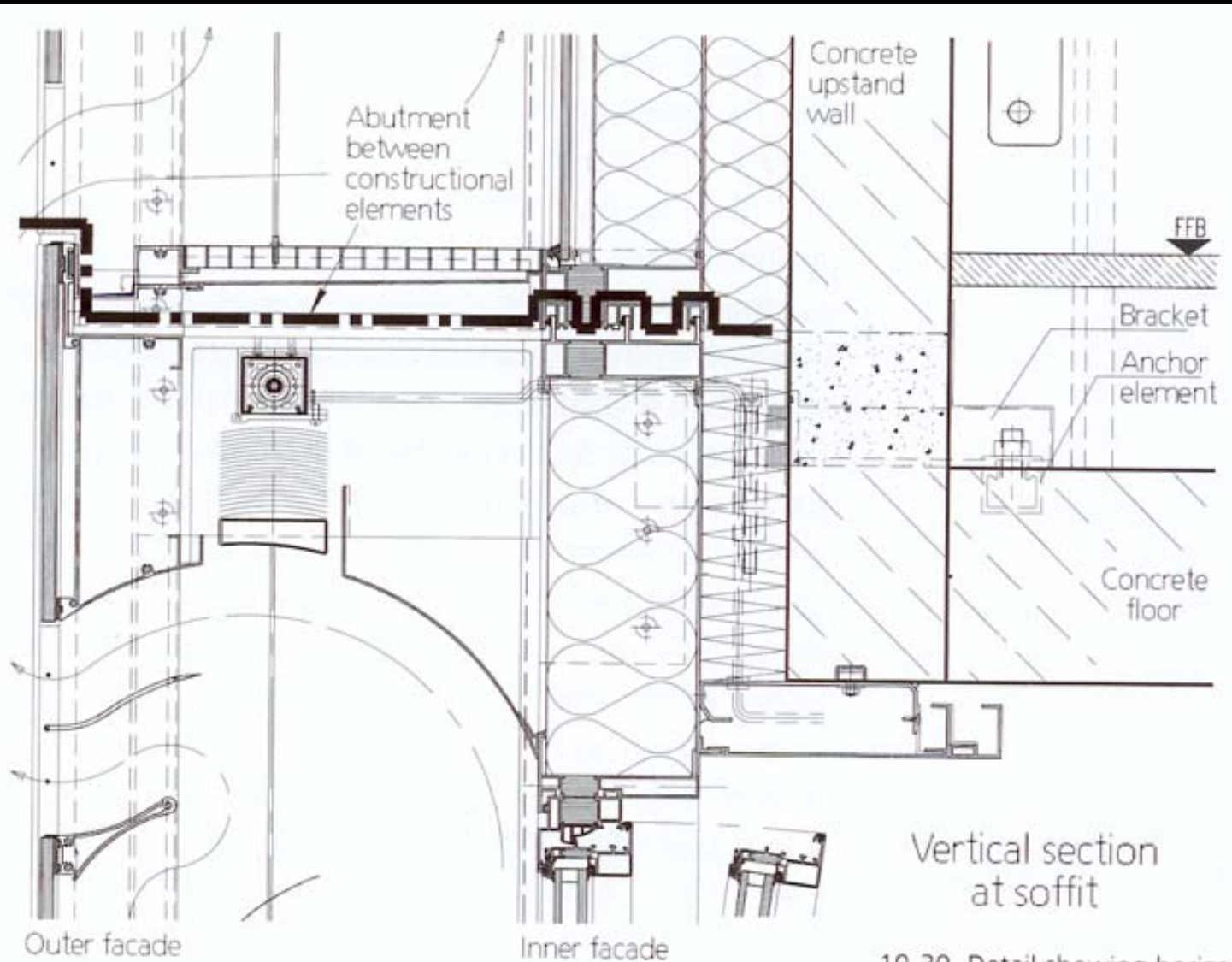

Vertical section at soffit

10-30 Detail showing horizontal line of abutment between elements at outer edge of floor slab in Business Tower, Nuremberg.

Horizontal section:
abutment between
constructional
elements

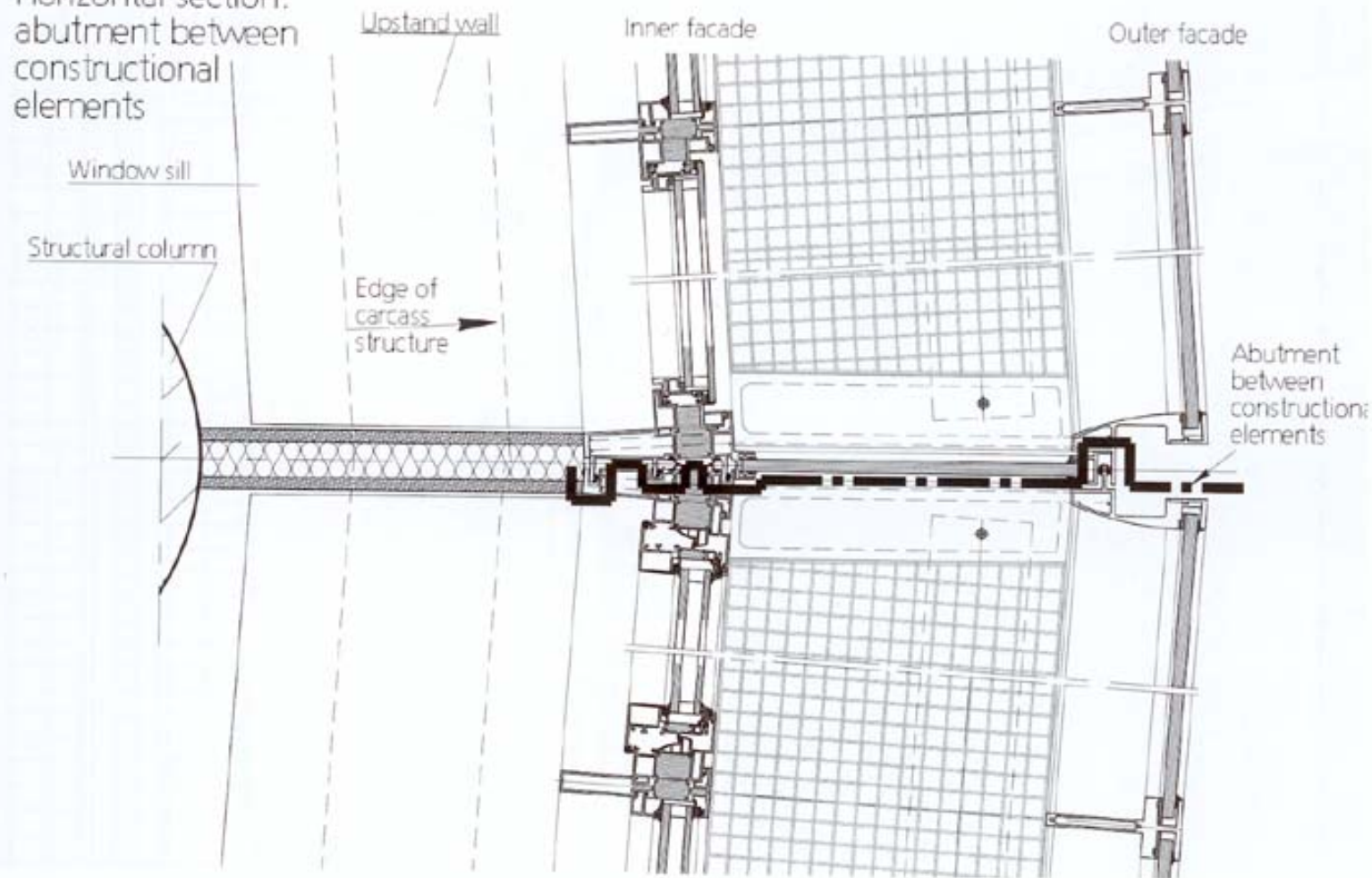

10-31 Detail showing vertical
line of abutment between
elements on facade axis of
Business Tower, Nuremberg.

The system is created with strict modularity to ensure that the components fit together properly. This can include working with odd geometries given the circular nature of this tower.

Debis Building, Potsdamer Platz,
Berlin

1998

Renzo Piano Workshop

hybrid type façade



Closer view of exterior of building façade system. It is generally speaking a twin-face system, however the terra cotta thermal elements and other unique features, class it more as a hybrid system.

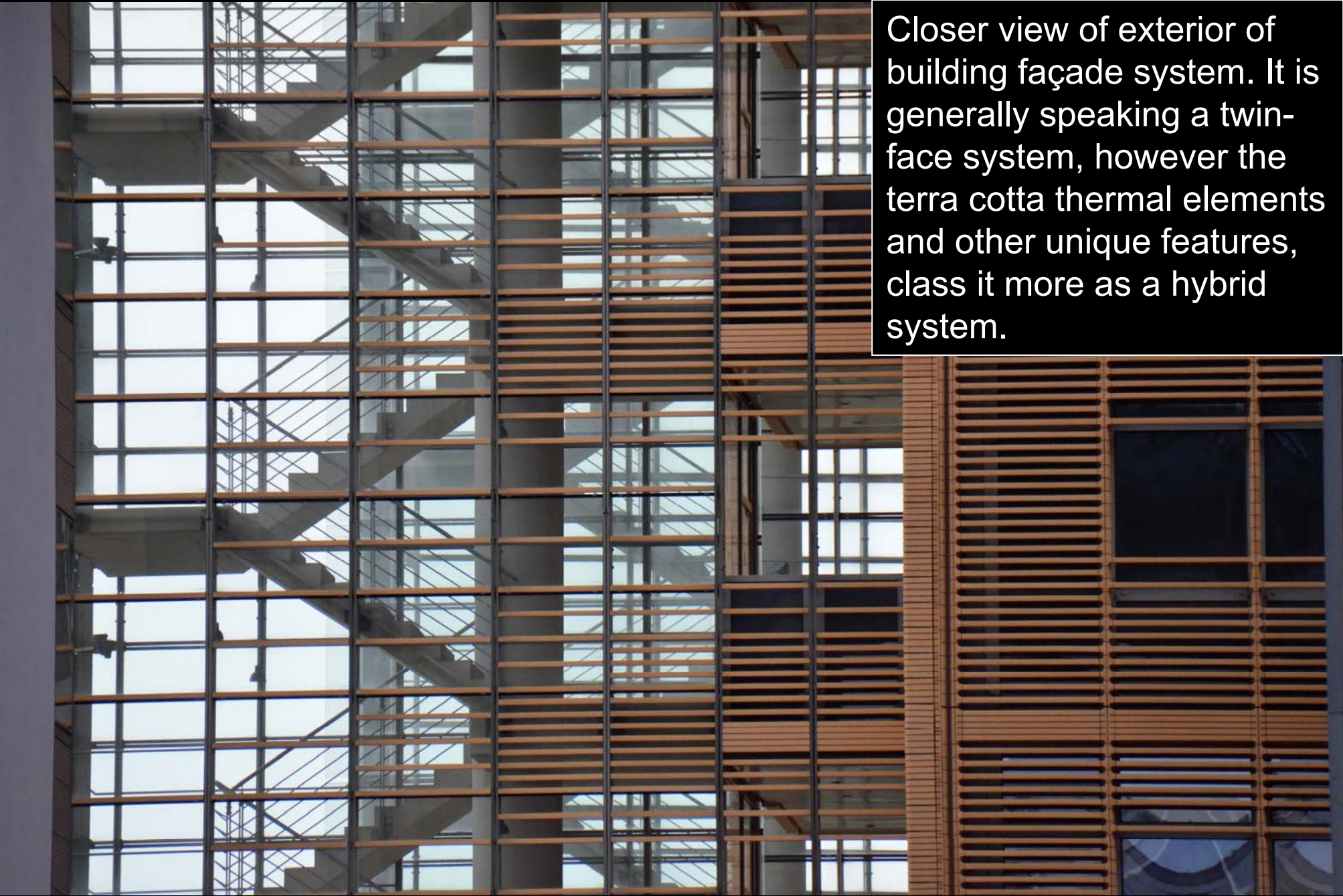

Detailed view
of some of the
terra cotta
elements that
are used in
the cavity for
both shading
and thermal
mass heat
control.

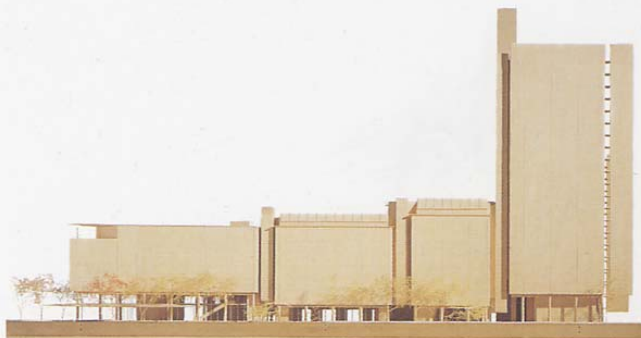
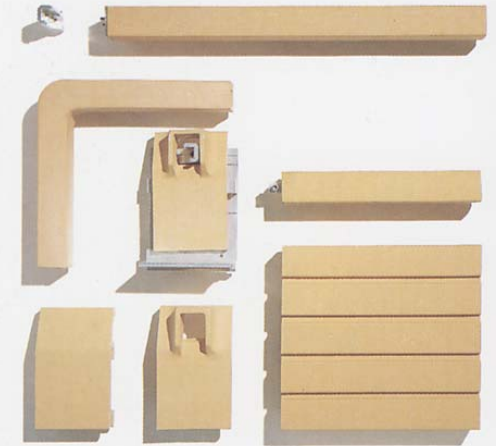



Section of façade

- 1 Tilt-and-turn window
- 2 Glass slats
- 3 Tilt-and-turn window (much like a jalousie)
- 4 Solar shading device
- 5 Rail, clad in terracotta
- 6 Fire resistant panels
- 7 Terracotta façade panel
- 8 Stainless steel grating
- 9 Safety glass
- 10 Fixed pane

The building users can control the fresh air entering the building by adjusting the angle of the outer glass slats as well as by two tilt type windows on the interior. The façade cavity is compartmentalized by floor.

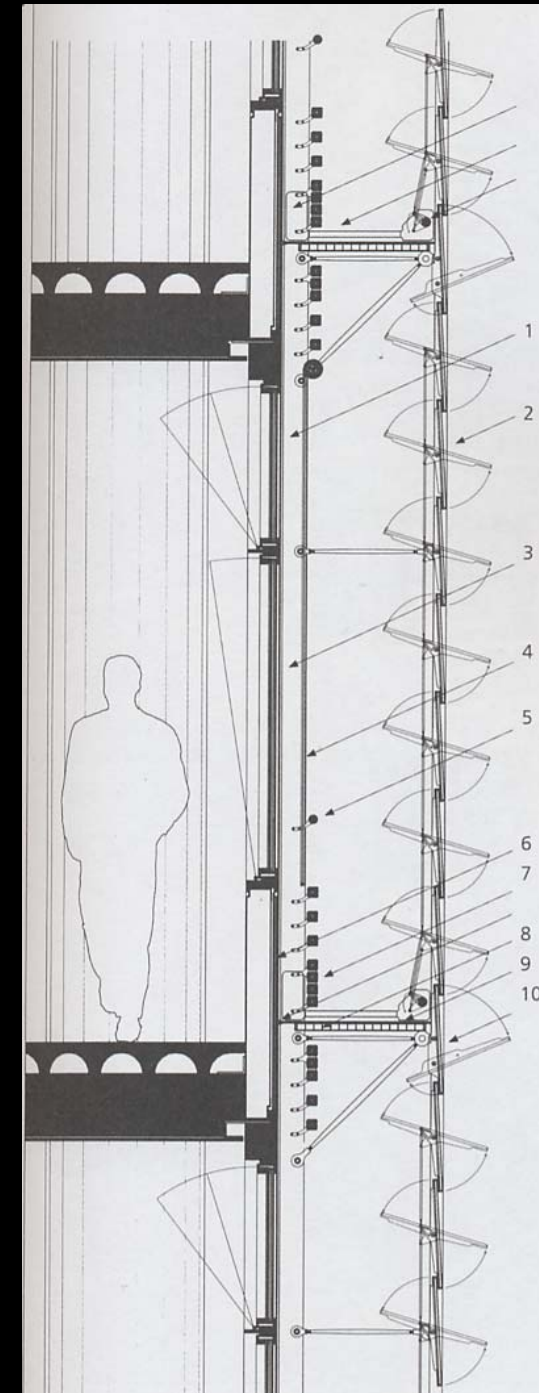

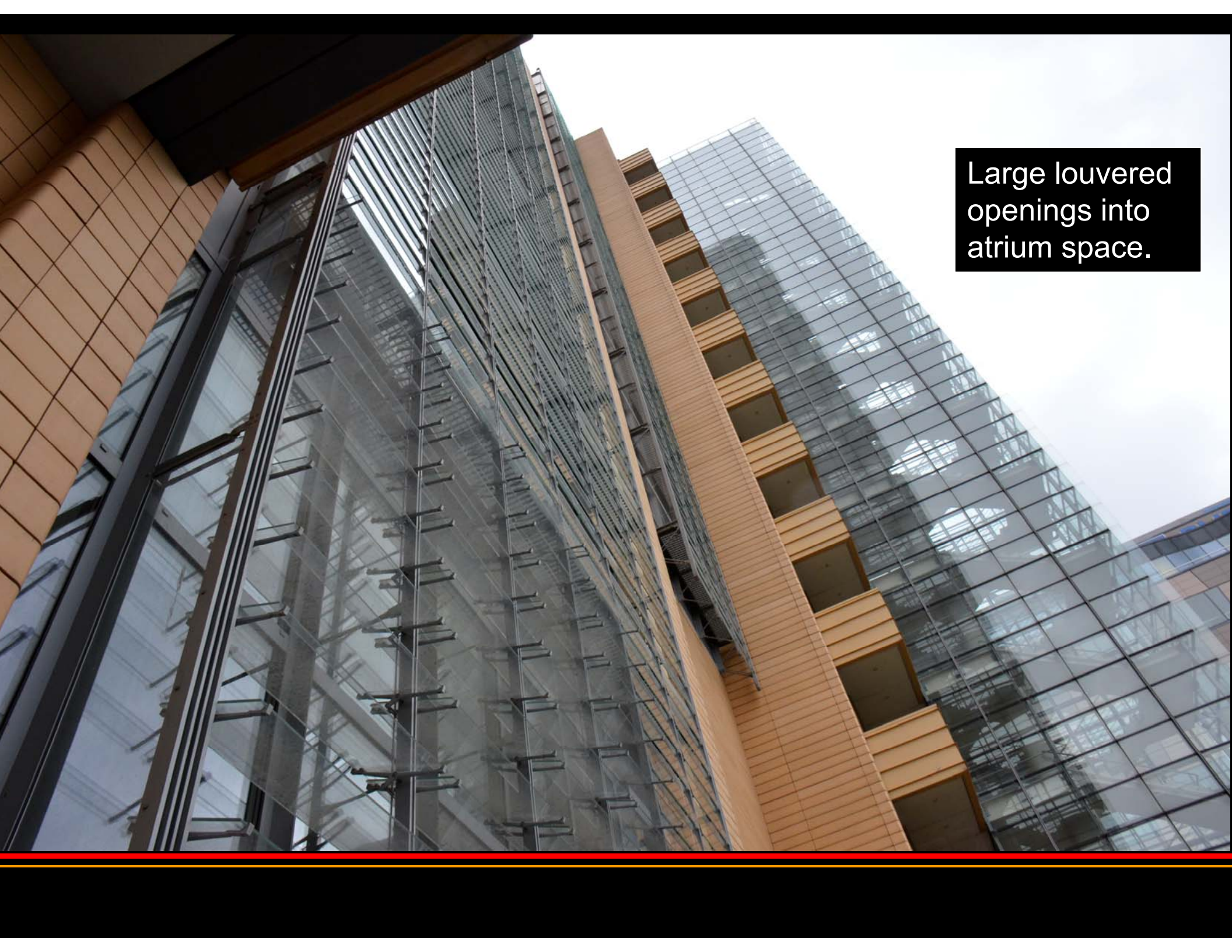

Large louvered openings into atrium space.

View along air space.

Note that the width is more than adequate for cleaning access.

In commercial buildings this does create issues with gross to net area calculations and “rentable space”.



12-6 Top: diagram of mechanical ventilation to room in debis building, Potsdamer Platz, Berlin, in winter.

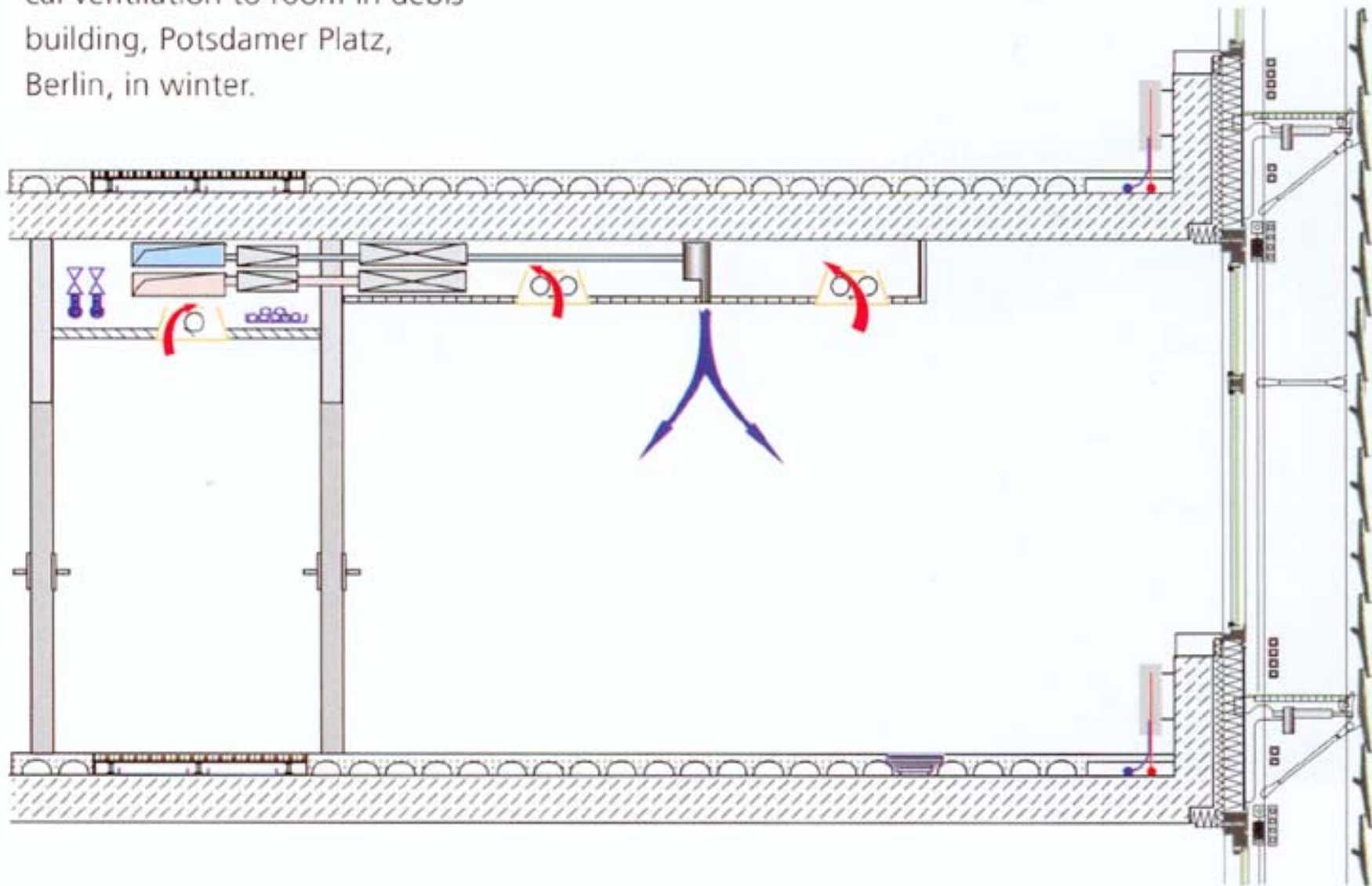

Mechanical ventilation, winter condition, exterior vents closed (heating mode).

12-7 Bottom: diagram of natural ventilation to room with open windows in debris building, Potsdamer Platz.

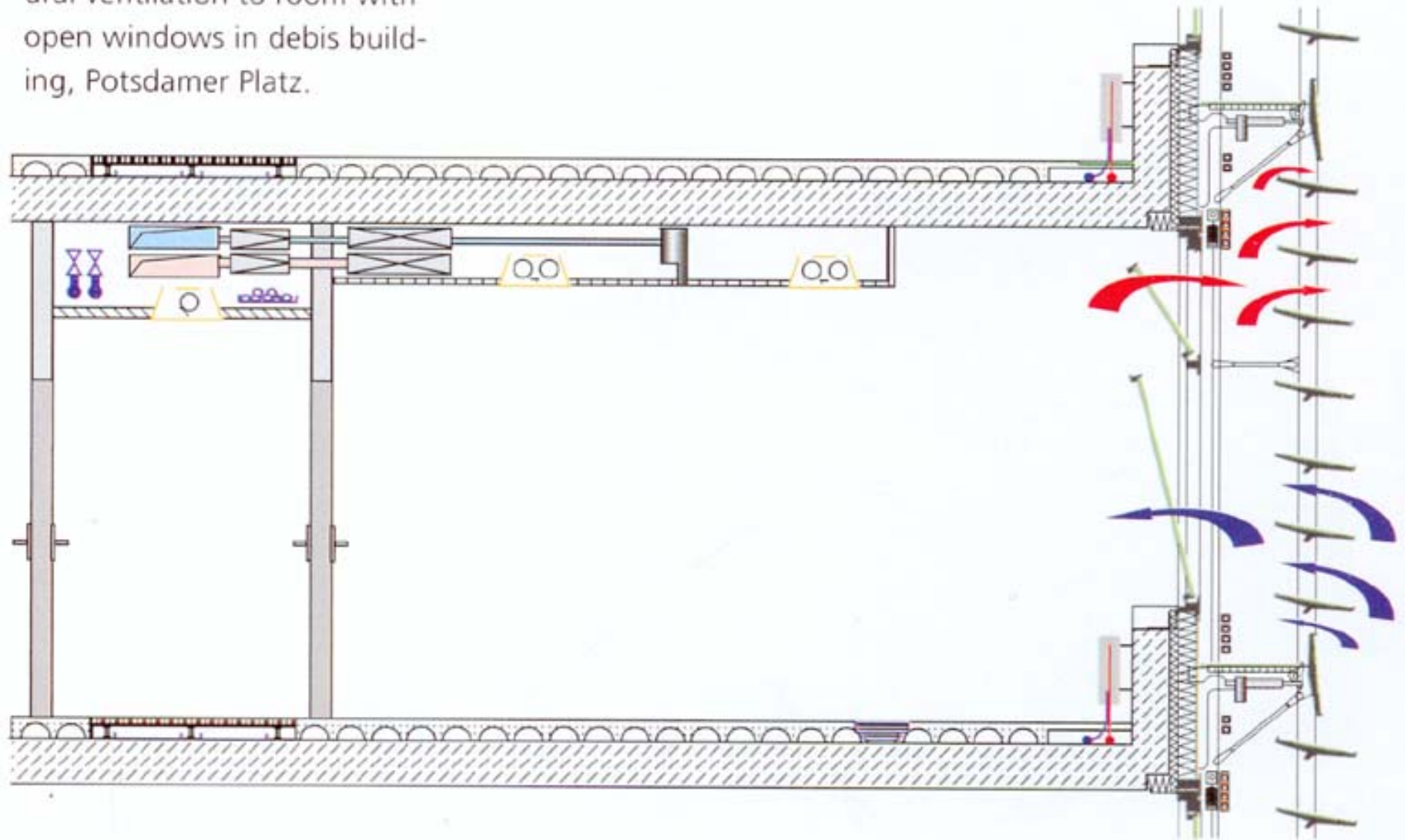

Ventilation strategy, cooling mode.

Interior view of typical office,
looking through double façade.



Swiss Re Headquarters, London, 2004
Architect: Sir Norman Foster



An ingenious use of natural ventilation creates an environmentally progressive working space. Daylight flooded interiors and the 360° panoramic view are complemented by superior, Class A performance specifications.

The building's fully glazed double-skinned façade is cooled by extract air from the offices, thus reducing the overall heat load. The façade has been designed to allow safe and efficient access to all internal and external glazing and cleanable surfaces. Goods access and handling areas are provided at basement level serviced by a vehicular access ramp from St Mary Axe.

A high performance grade A specification providing:

- Design criteria of one person per 10 sq m.
- Four pipe fan coil air conditioning system combined with
 - the option for natural ventilation.
- 2.75m typical finished floor to ceiling height.
- 150mm raised floors.
- 16 high-speed, high-capacity passenger lifts.
- 1.5m planning grid.

<http://www.30stmaryaxe.com/>



Structure and Cladding

The 180m tall tower is supported by a highly efficient structure consisting of a central core and a perimeter diagrid – a grid of diagonally interlocking steel elements. Some traditional central cored buildings of this height would use the core as a means of providing the necessary lateral structural stability. Because of the inherent stiffness of the external diagrid, the central core is required to act only as a load-bearing element and is free from diagonal bracing, producing more flexible floor plates.



The fully glazed skin of the building allows the occupants to enjoy increased external awareness and the benefits of daylight. The glazing of the office areas comprises two layers of glass with a cavity, which is ventilated by the used air drawn from the offices. This enables solar radiation to be intercepted before it reaches the office spaces to reduce the typically large air conditioning load.

The cladding of the lightwells consists of simple operable and fixed double glazed panels with tinted glass and a high-performance coating to reduce the penetration of solar radiation.

IMAGING SIX LAYERS OF ETHIC LINES, WRAPPED IN GLASS, AND SEALED TIGHTLY IN A CUBE

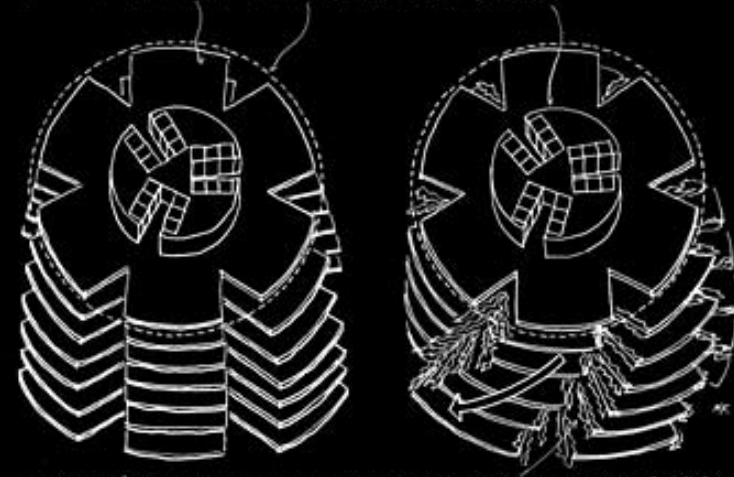

THESE ARE THEN ENCLOSED IN GLASS. THE PANELS ARE SEPARATED BY A SPACE TO OPEN SPACES - THE LAMP OF THE BUILDING



The structural steel “diagrid” has become popular in current buildings and presents geometrical issues when detailing the cladding systems.





Construction images

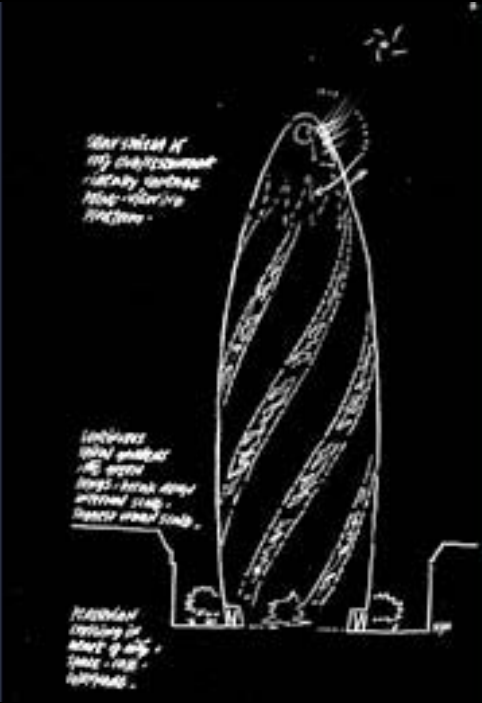



The building was used as a recognizable backdrop in "Basic Instinct 2"

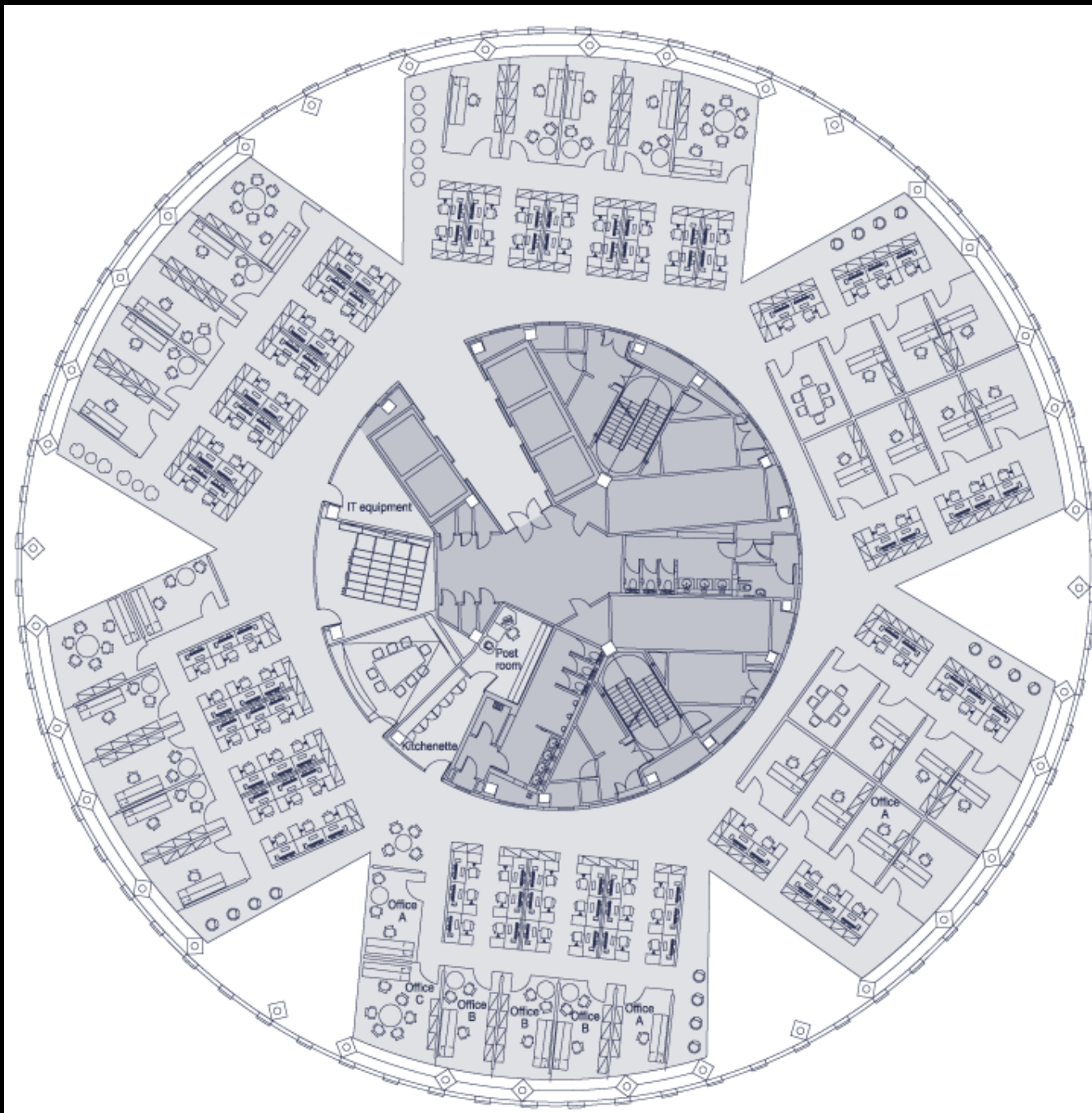

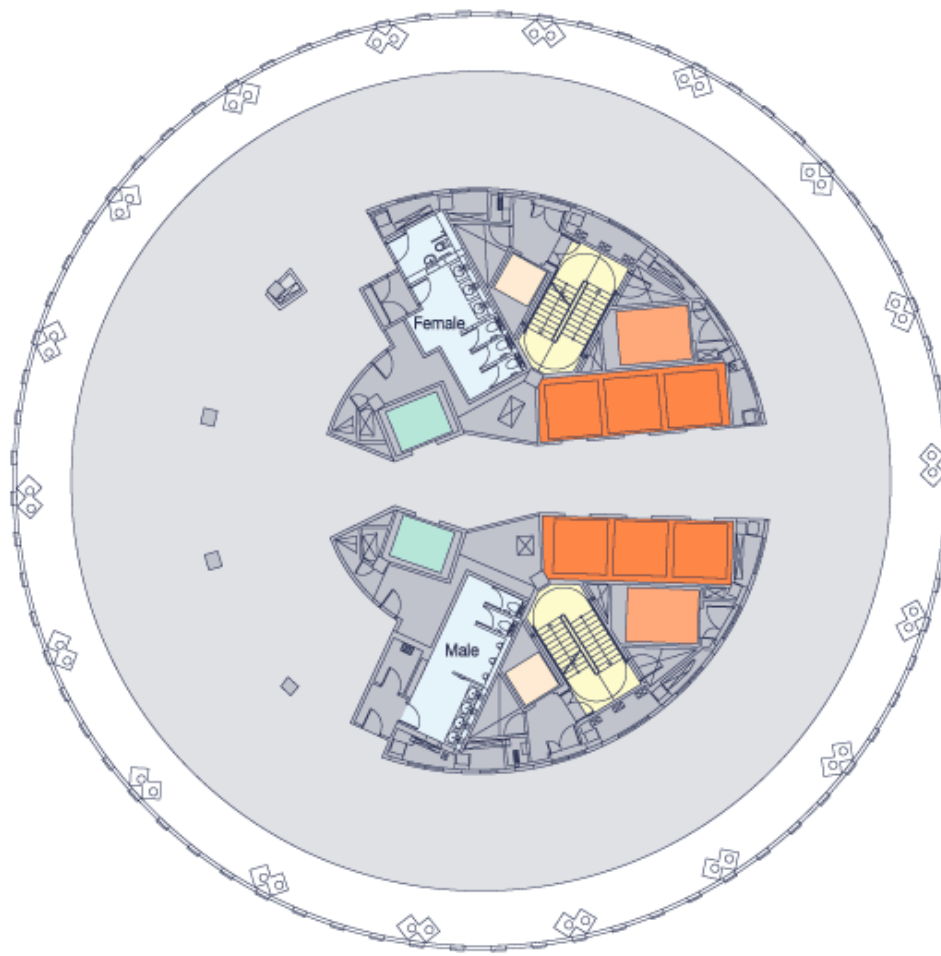

608 sq m
6,542 sq ft

- Passenger Lift
- Goods Lift
- Fire Lift
- Fire Stairs
- Toilets
- Core Area
- Floor Area
- - - Line of Floor Above



Exterior window cleaning to protect the “curved” glass

Office Building, Berlin
Petzinka Pink and
Partners

ventilated, acoustic
buffer façade

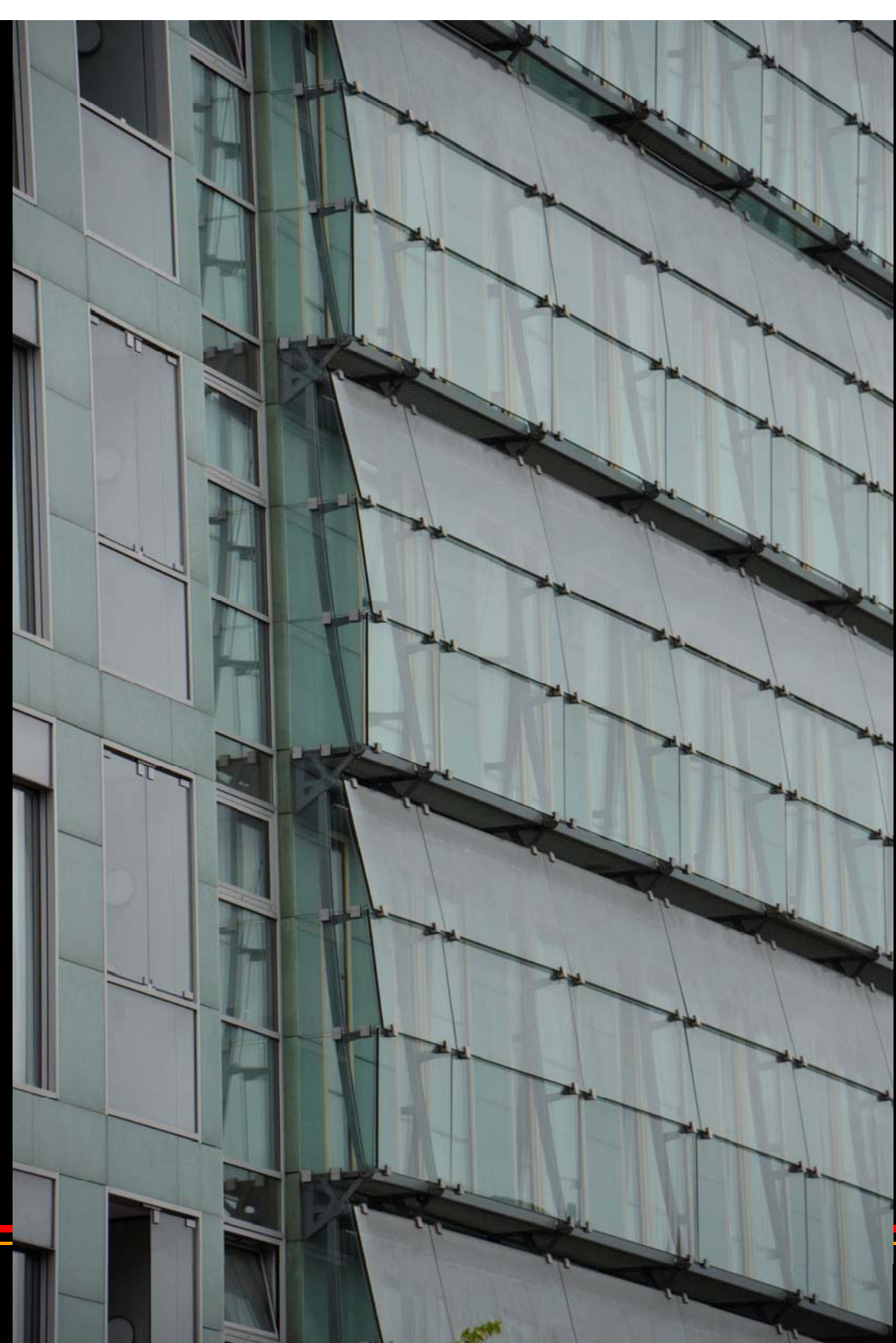
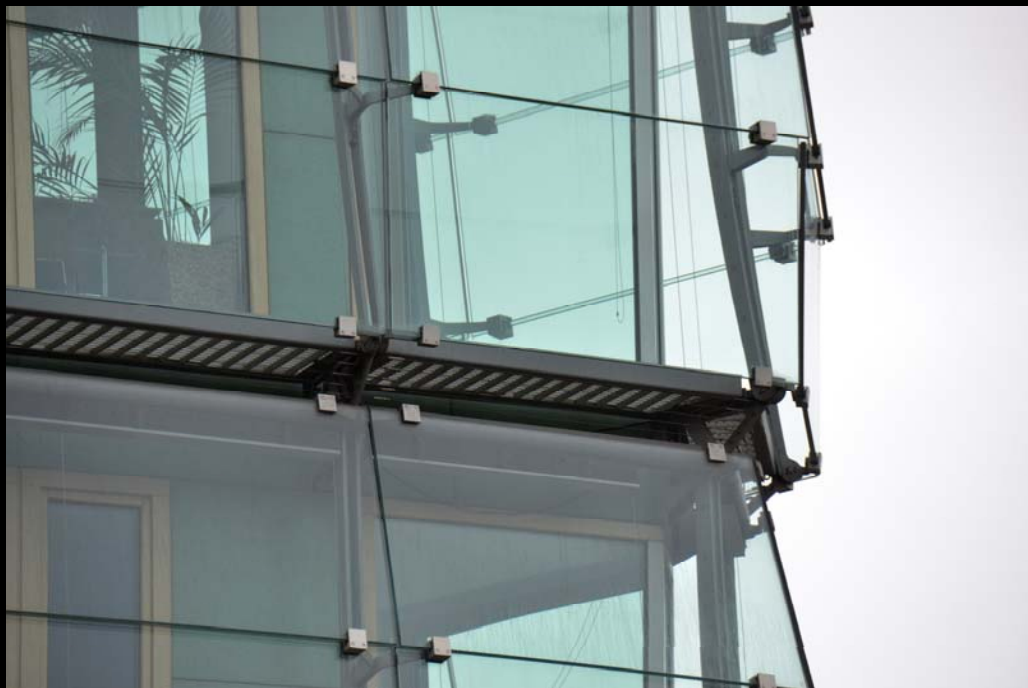

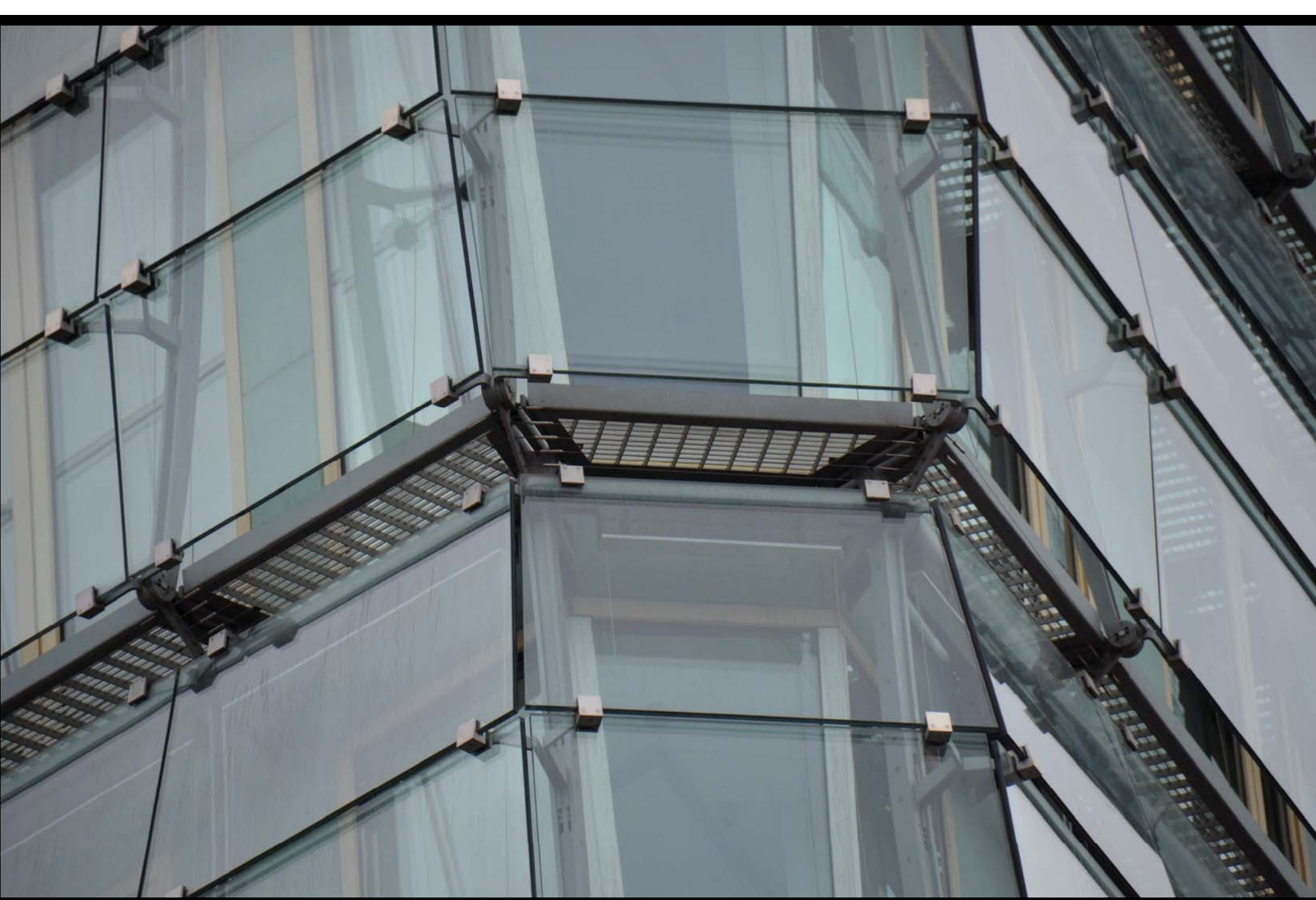



Office Building, Berlin

ventilated, acoustic
buffer façade



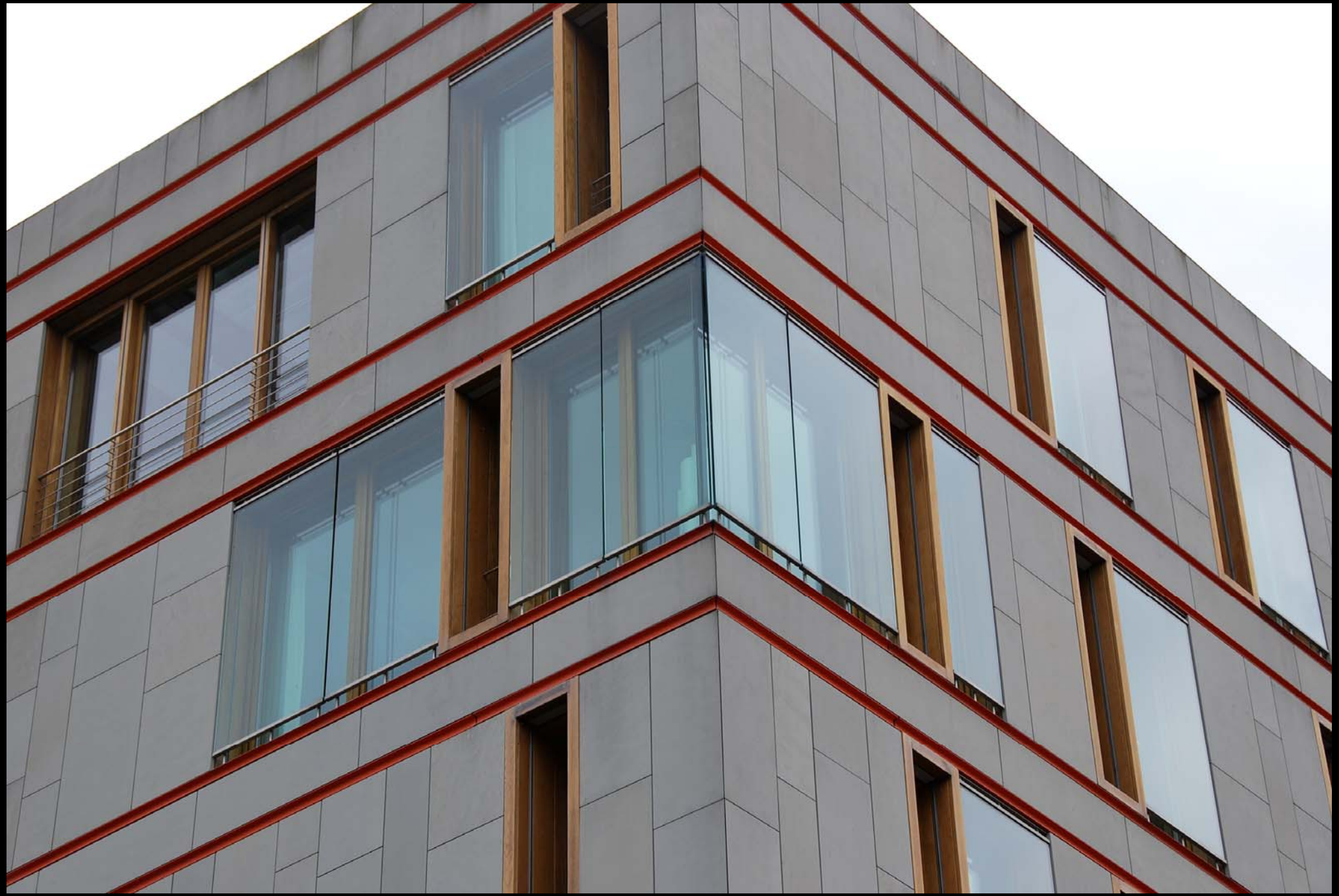





Operable windows on inside that tilt inward and operable vent at top of external pane of glass allow for flow through ventilation.

Lightweight venetian type blinds protected in cavity.

What are the issues regarding cleaning and access?

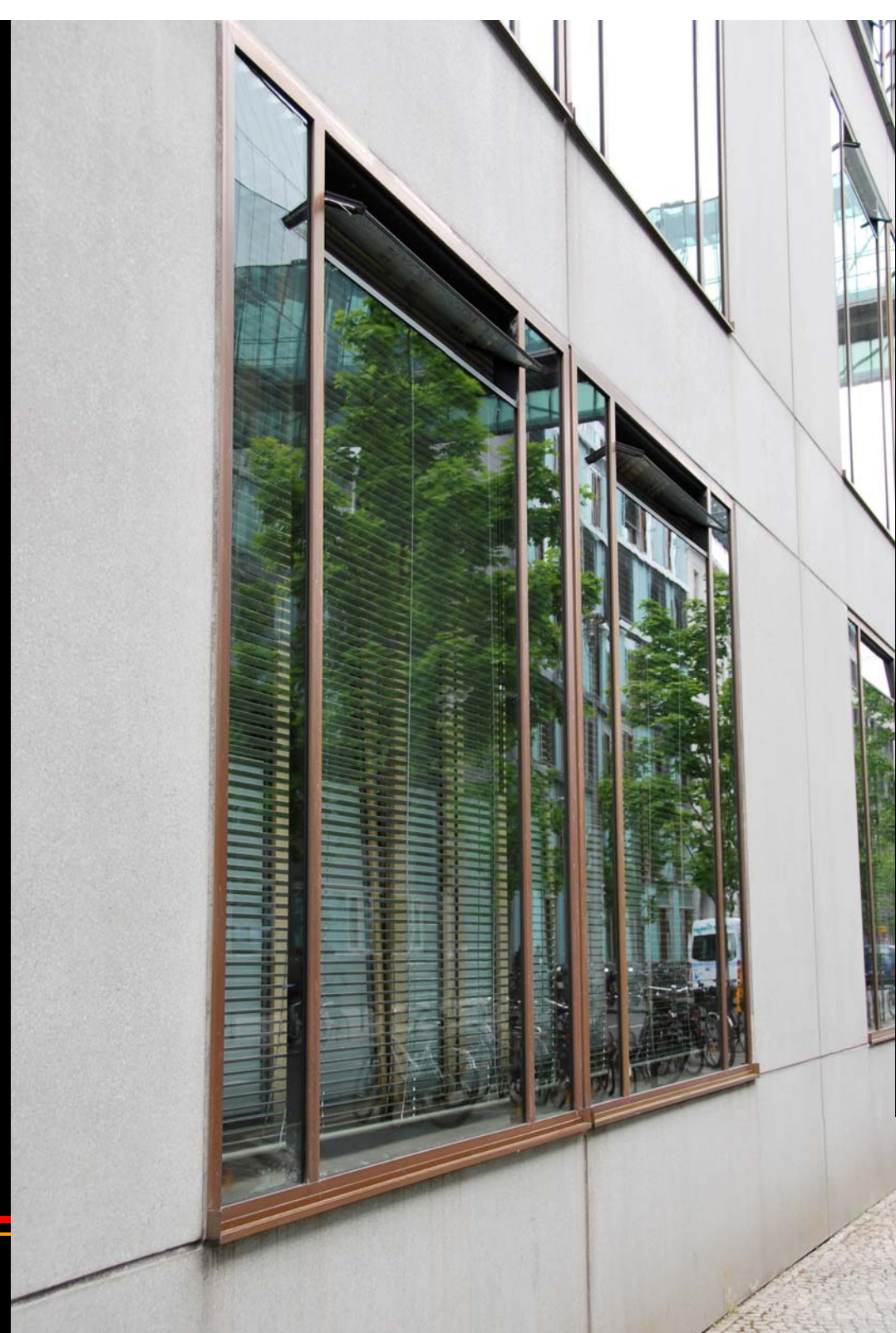

Office Building, Berlin

sealed, acoustic buffer
façade







Office Building, Berlin

moveable blinds as
second skin – modified
hybrid type of
application





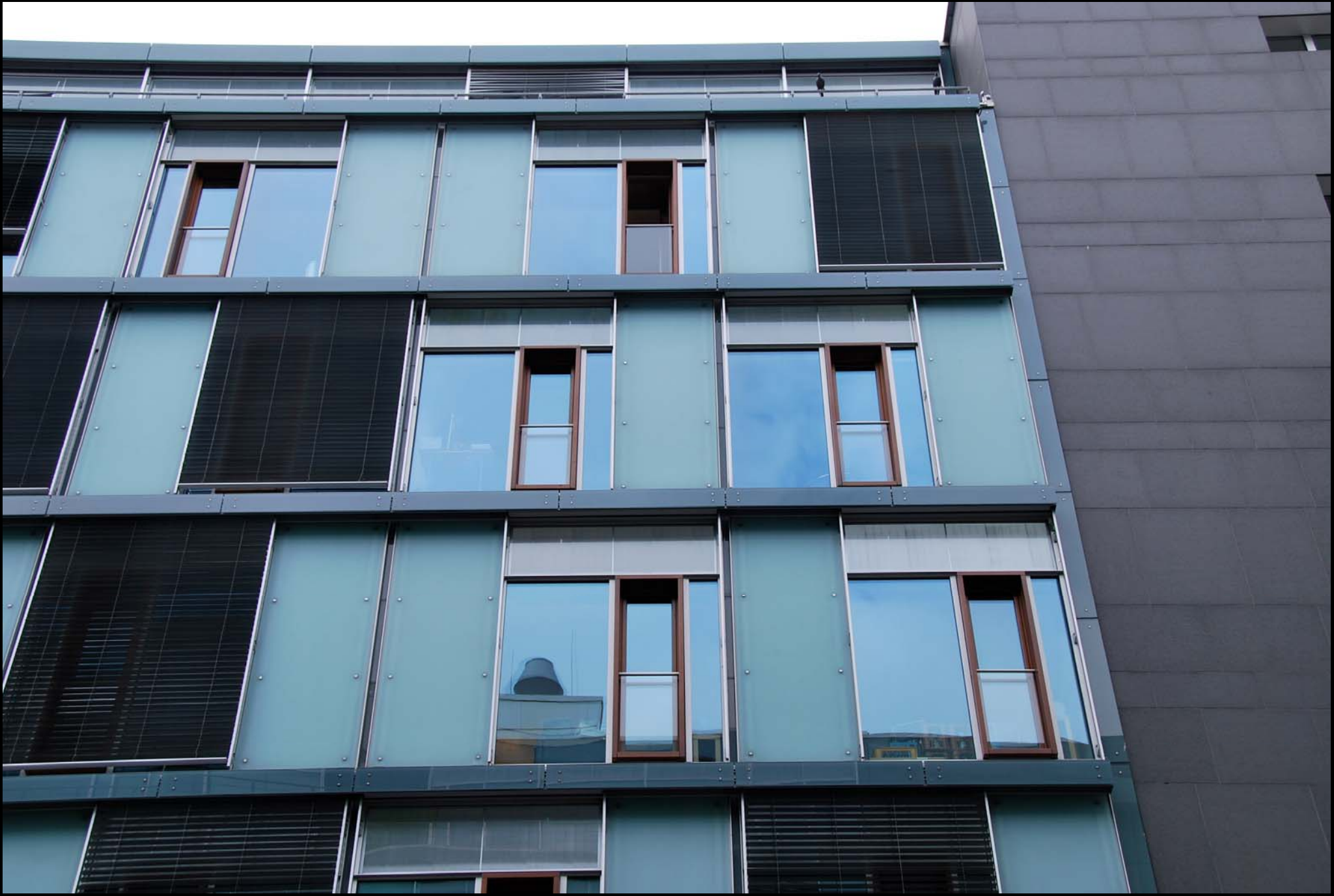



Office Building, Berlin

moveable blinds as second skin – lower part of shade is fixed to act as a balcony railing.





GSW Headquarters,
Berlin

Sauerbruch Hutton
Architekten w/Arup
2000

twin face system









Hot Climate Double Façades

- Issues of extreme heat lead to a priority for SOLAR AVOIDANCE
- Major issues with humidity
- Often problems associated with windborne sand
- Two types of façades have developed:
 - Where the exterior skin is a modified “mashrabiya” and is not glazed
 - Where the exterior skin is glazed but the shading devices are placed inside the building

Mashrabiya shading



The New Souk and Masdar City, Abu Dhabi, UAE – Foster + Partners

A louvered skin that is traditionally made from a wooden lattice. Affords airflow, prevents major solar penetration and provides privacy. Traditional Islamic vernacular.

Al Bahar Towers
Abu Dhabi, UAE

Aedas Architects w/ Arup

2011

A responsive shading façade covers the east, west and south faces of the towers.

North façade left clear for views to the city.







Doha Tower
Doha, Qatar

Ateliers Jean Nouvel

2010

A fixed exterior skin that acts as a shading device covers the all glass façade of the tower.

Opacity is varied according to the orientation.



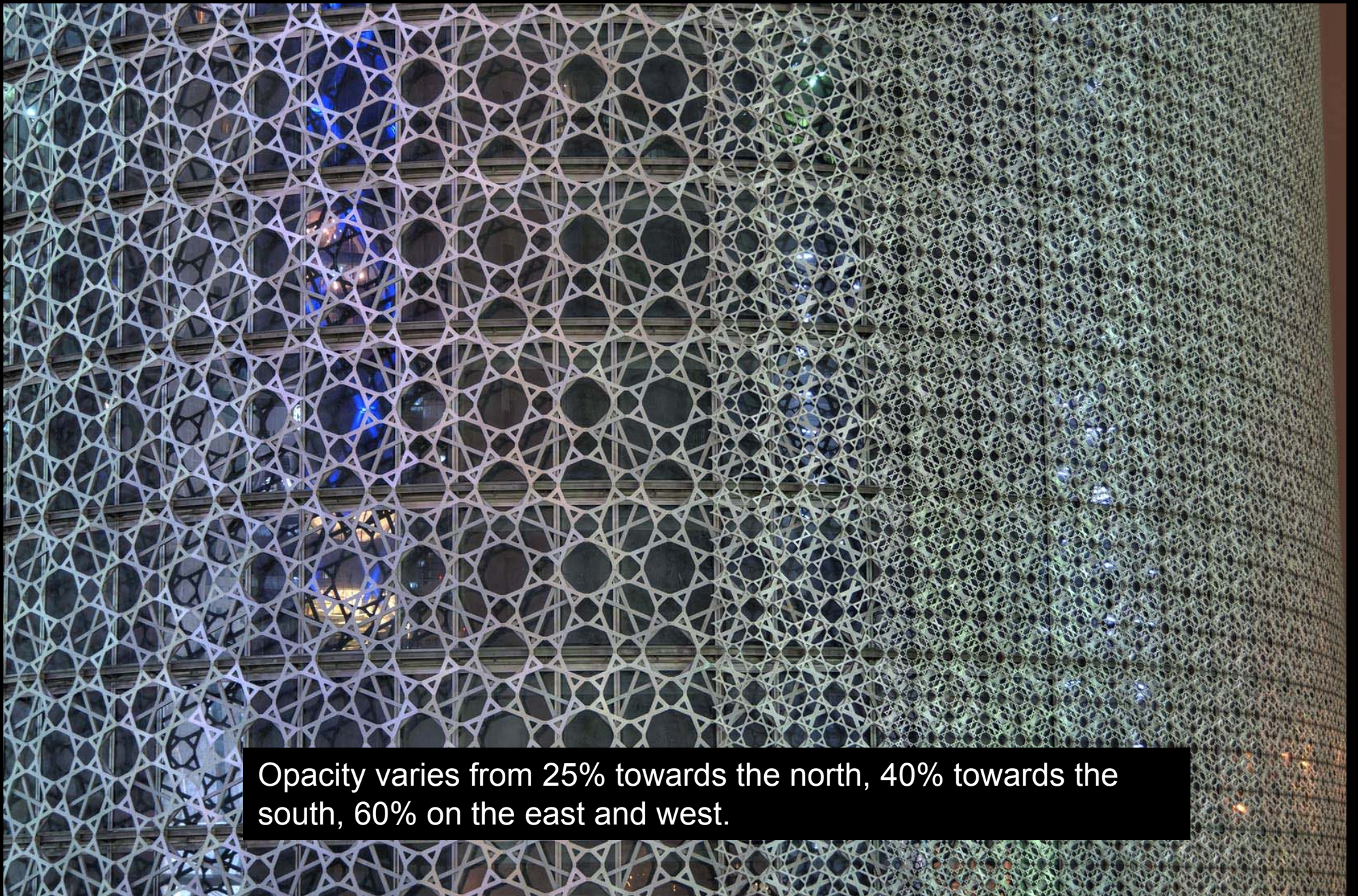

Opacity varies from 25% towards the north, 40% towards the south, 60% on the east and west.

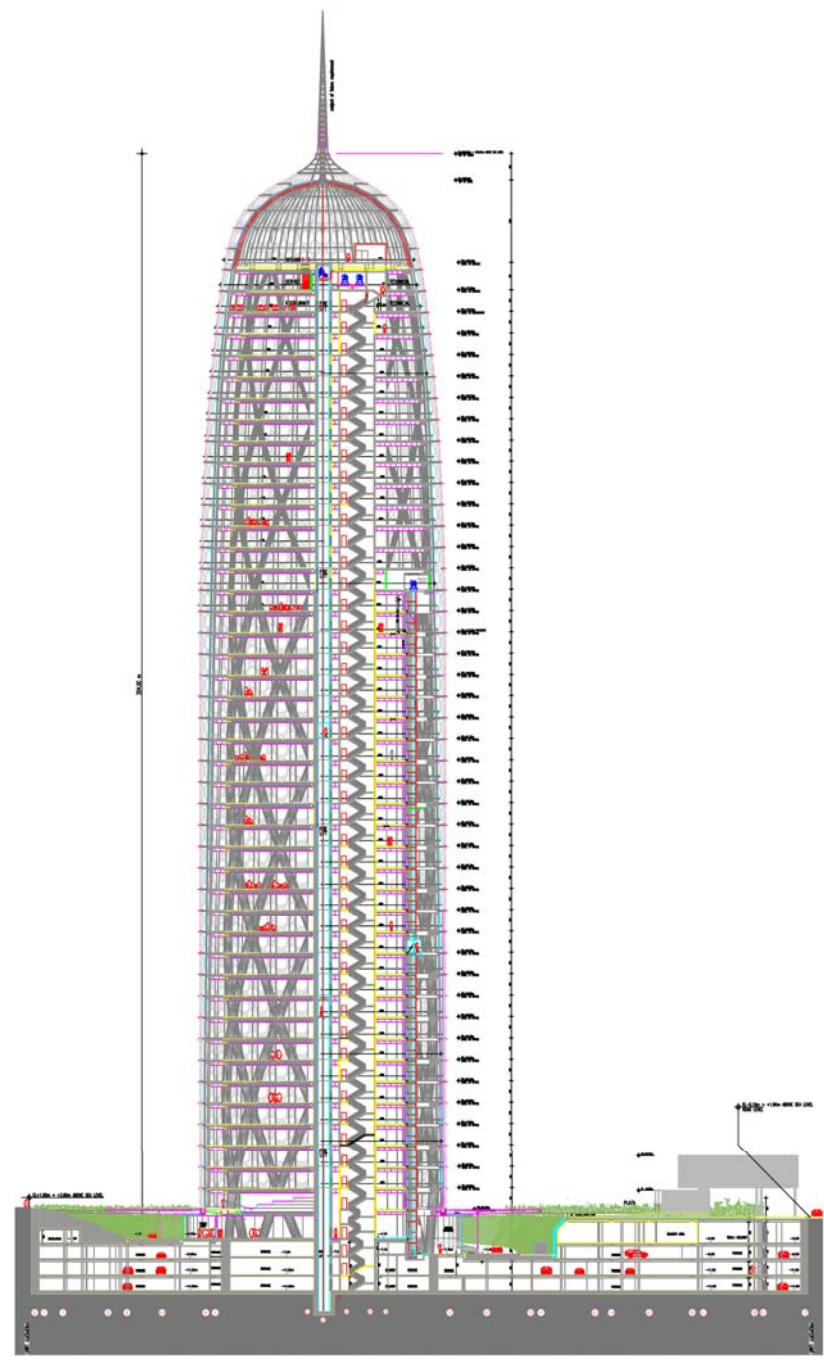
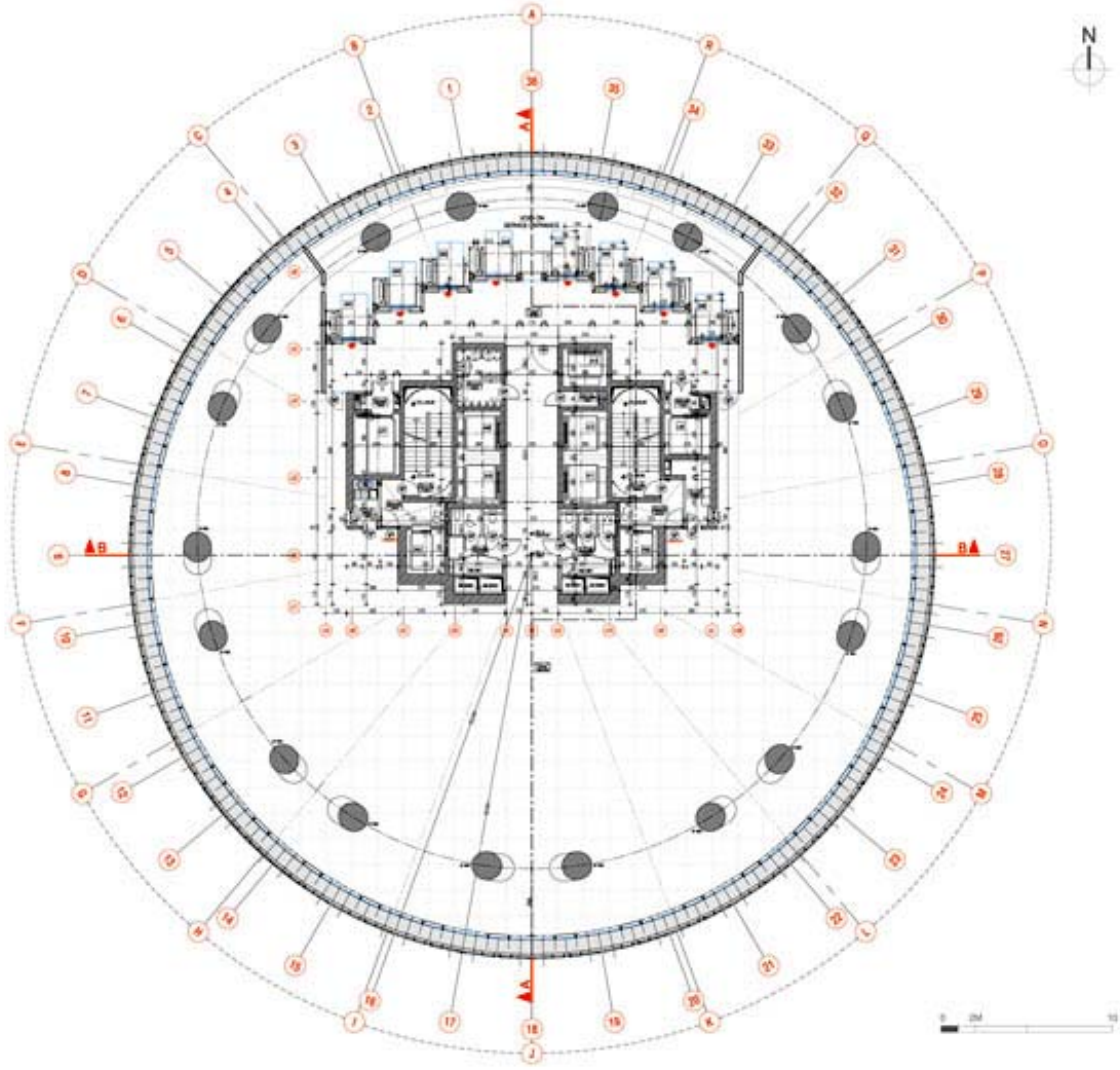

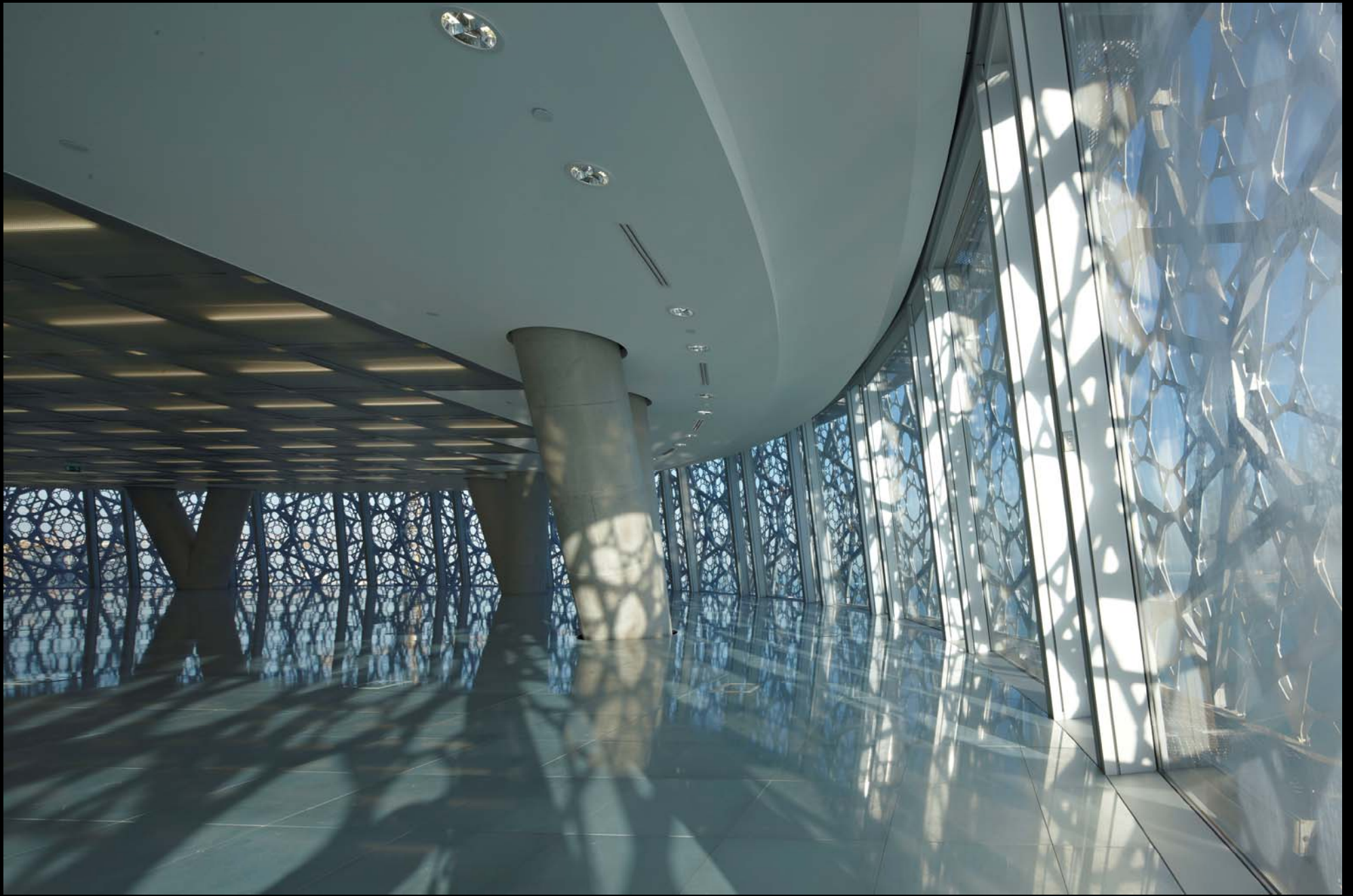

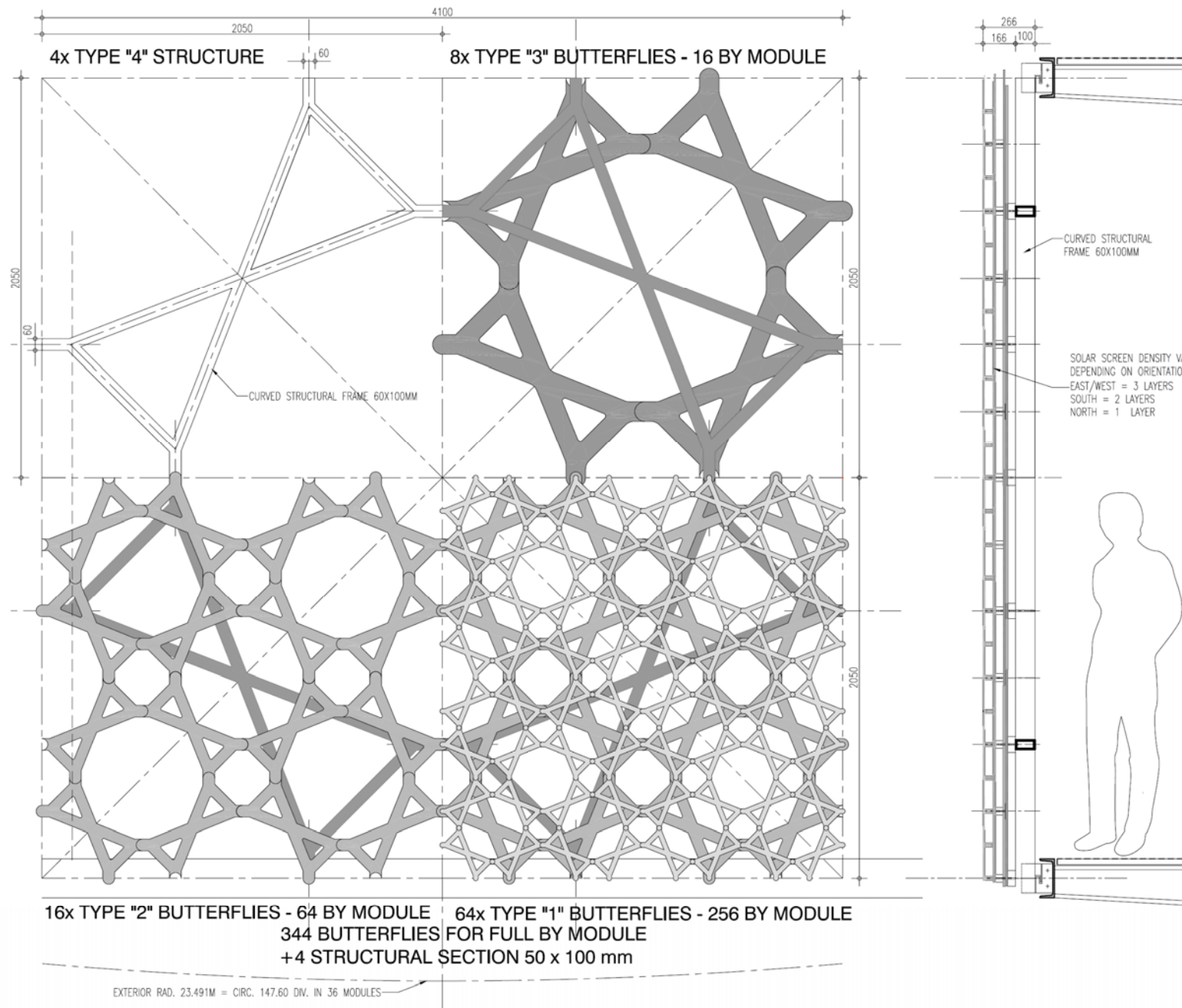

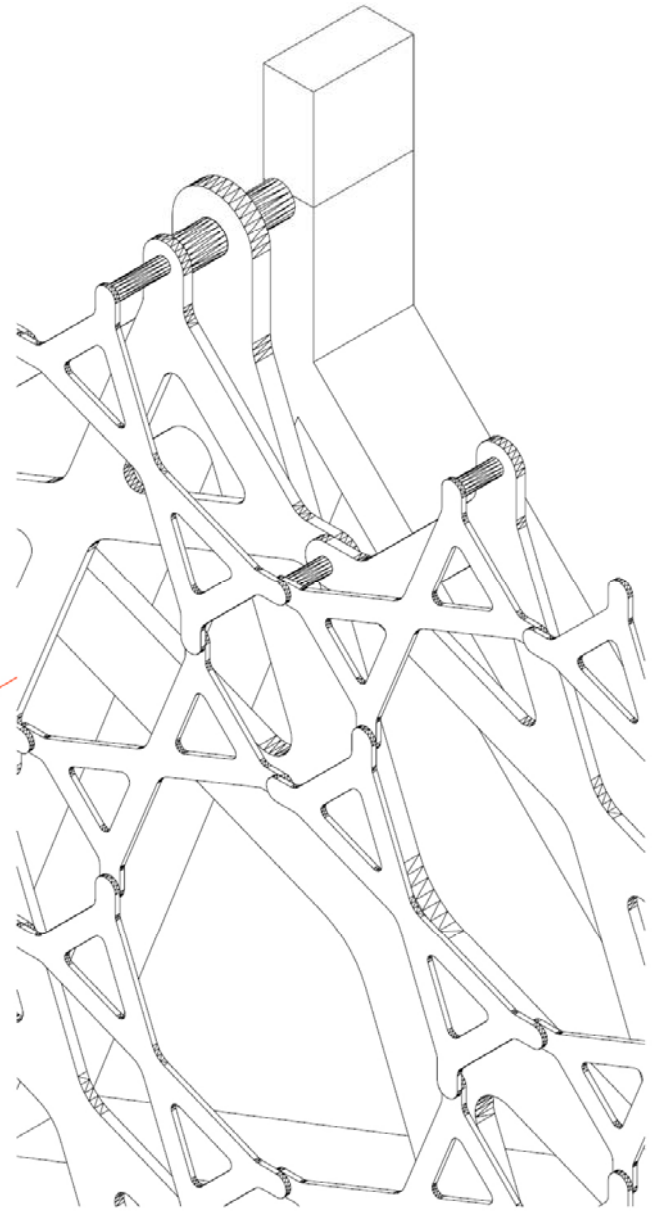
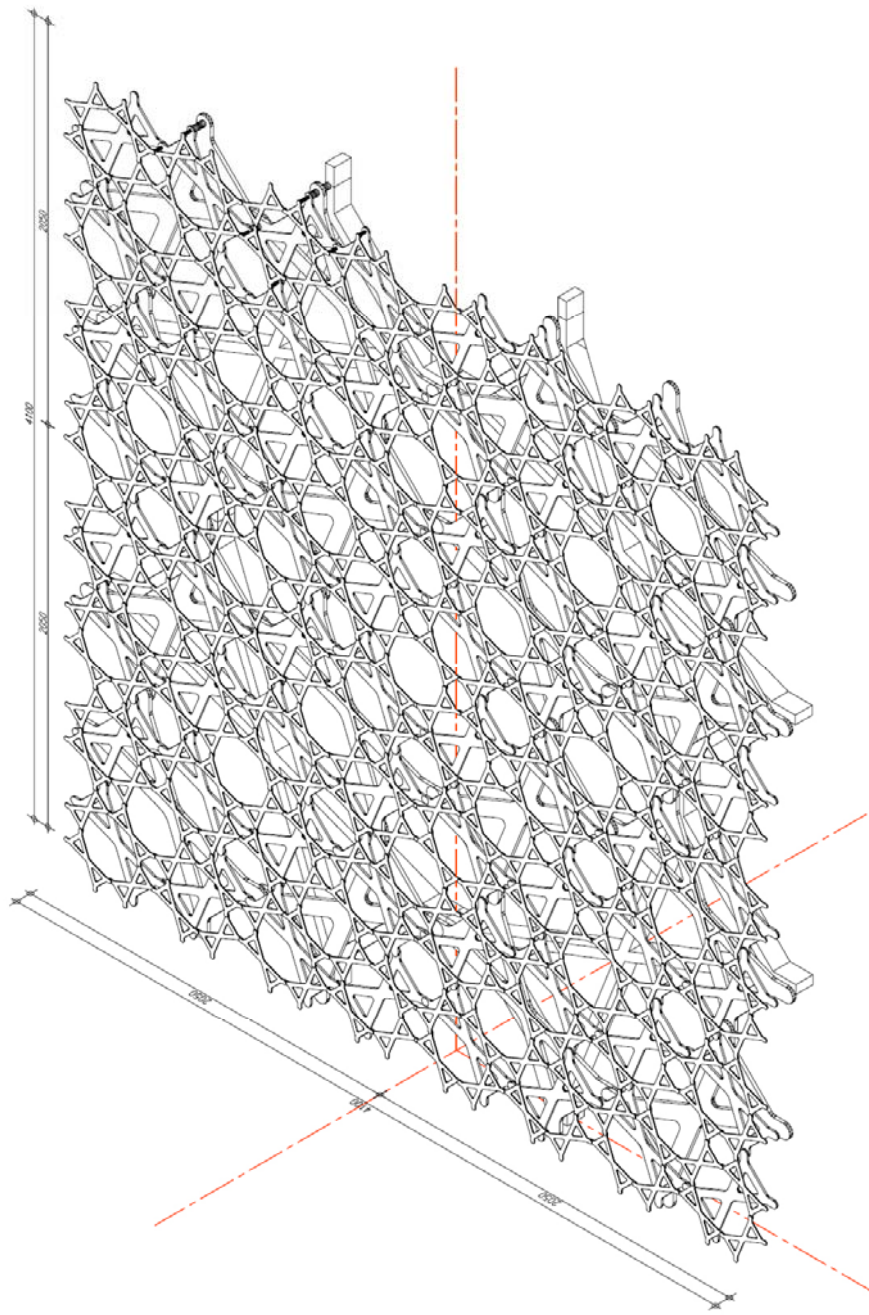

Capital Gate
Abu Dhabi, UAE

RMJM Architects

2012

Leans backwards 18°

Front side uses a metal screen for shading as the second façade

Top side opposite uses a more classic extract-air type façade to buffer the heat.

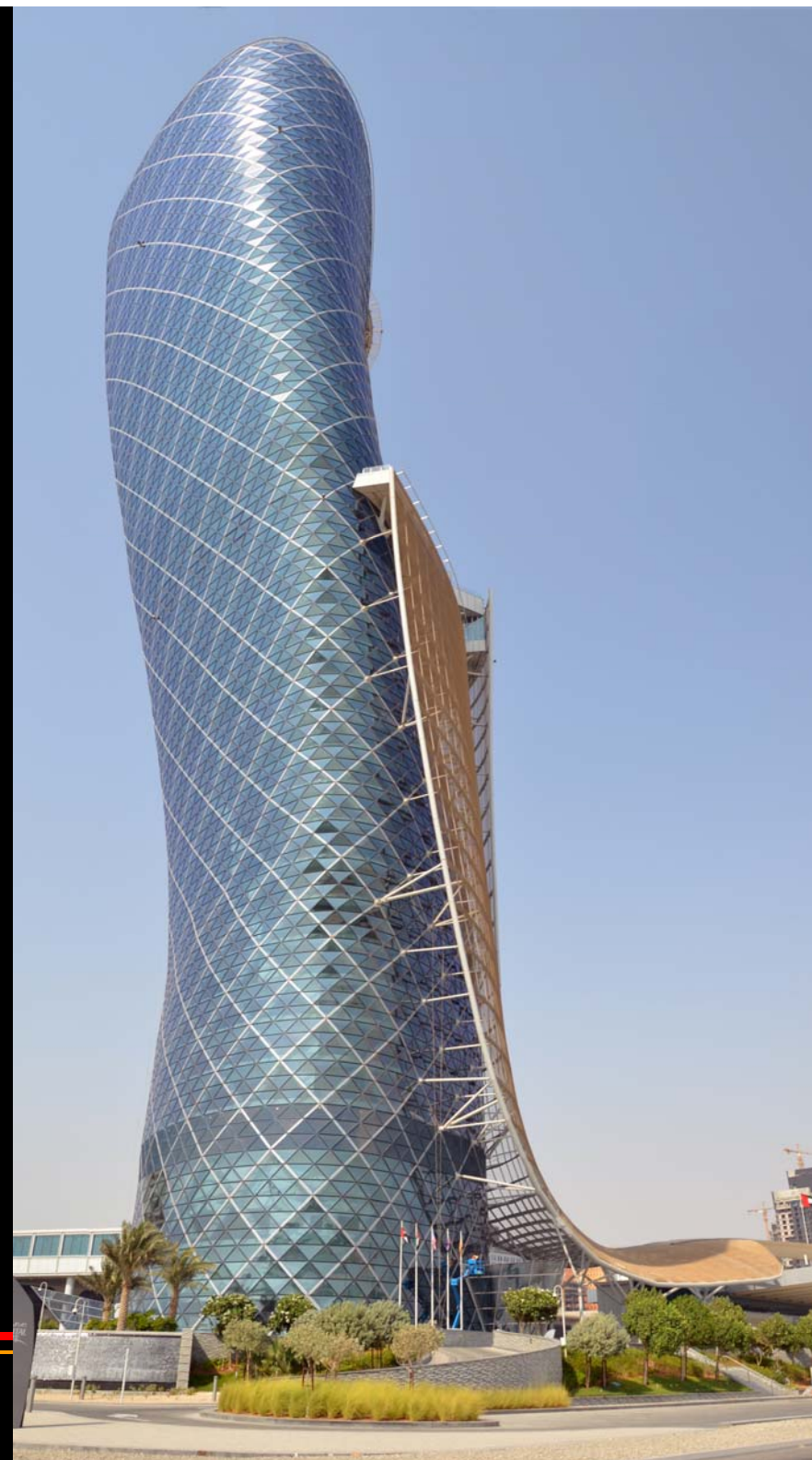

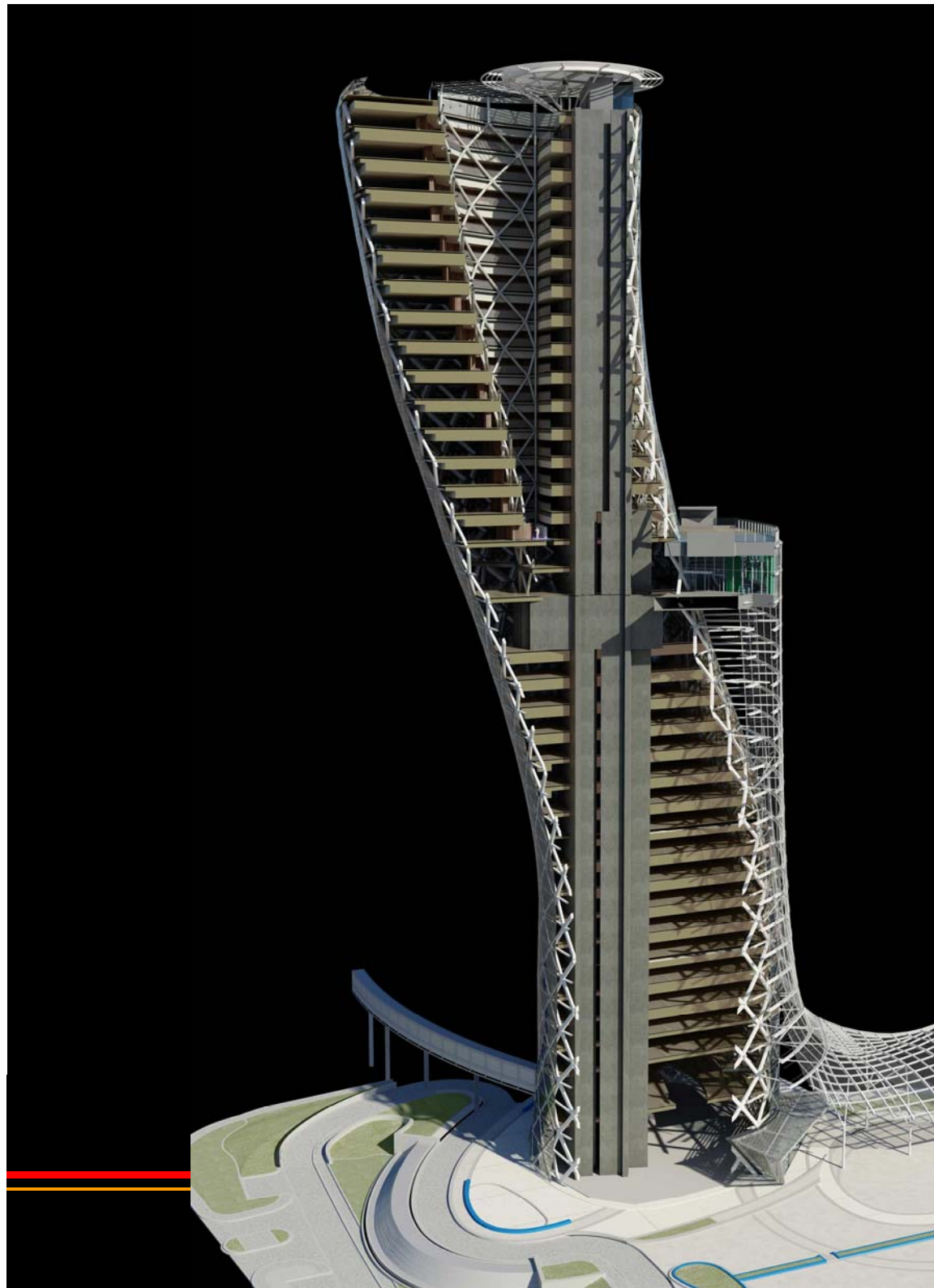
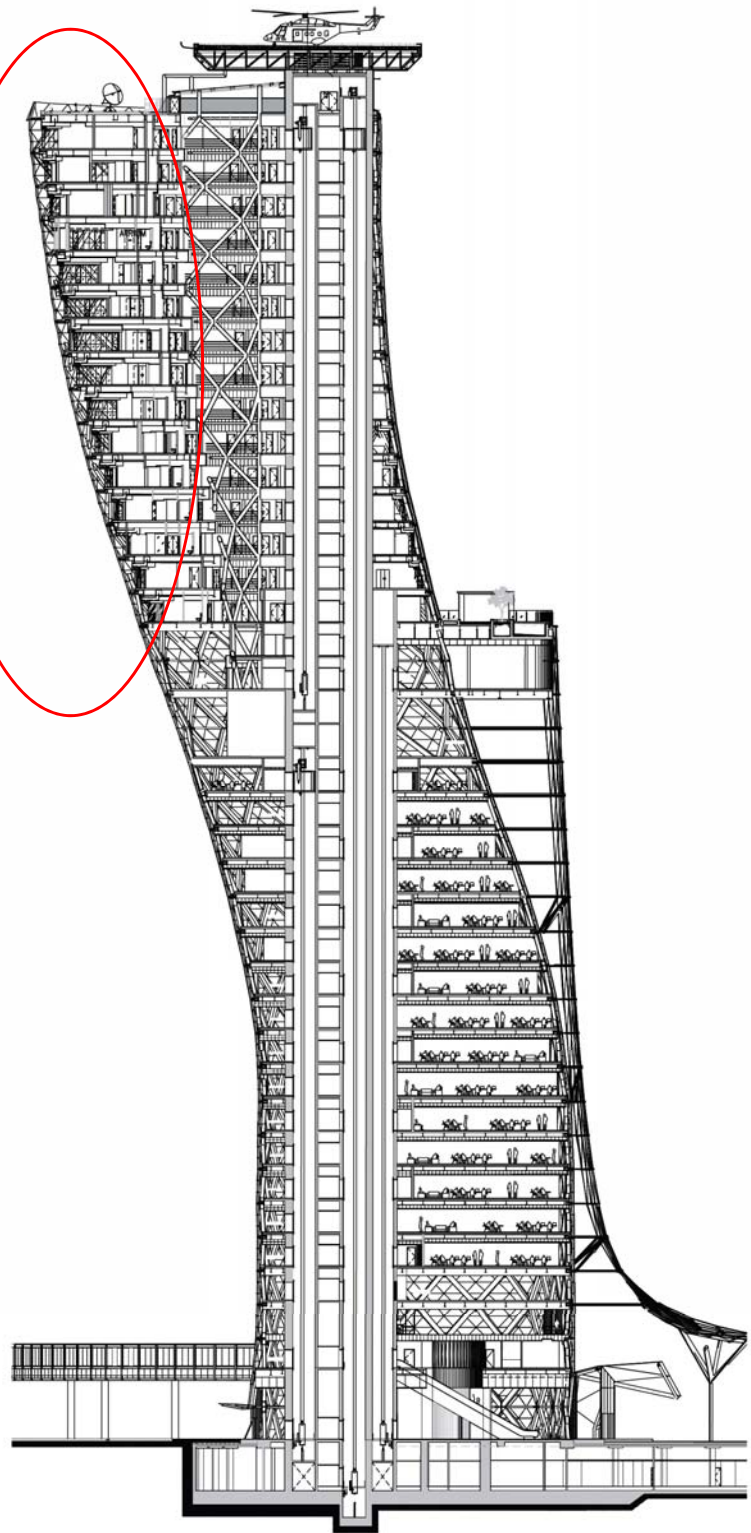

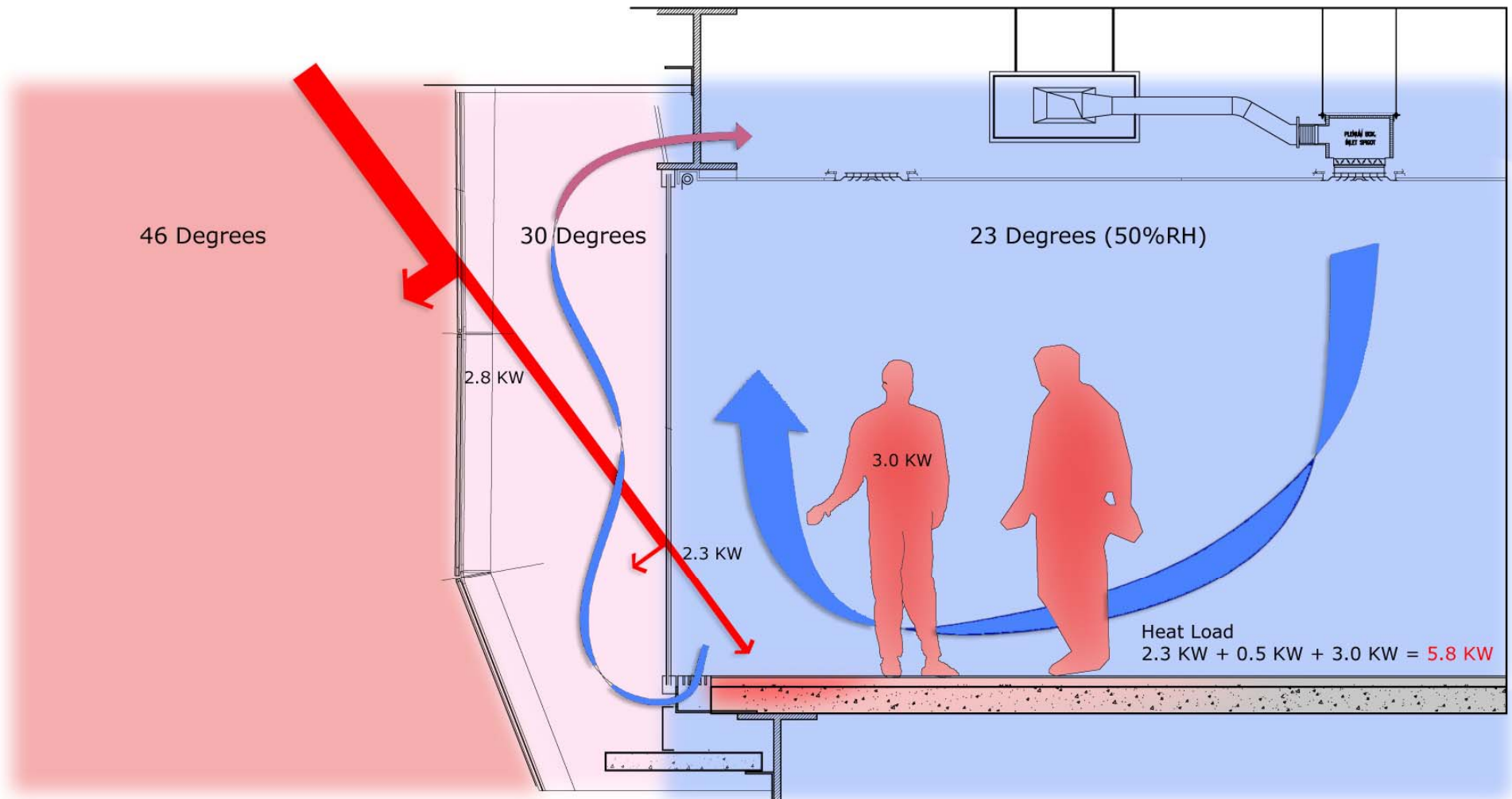

Solar Load
 U-Value = 1.8
 Sc = 0.35

Trans Load
 U-Value = 1.3 Total

Heating Gain from People,
 Lighting & Appliances
 = 3.0 KW

Heat Load
 $2.3 \text{ KW} + 0.5 \text{ KW} + 3.0 \text{ KW} = 5.8 \text{ KW}$

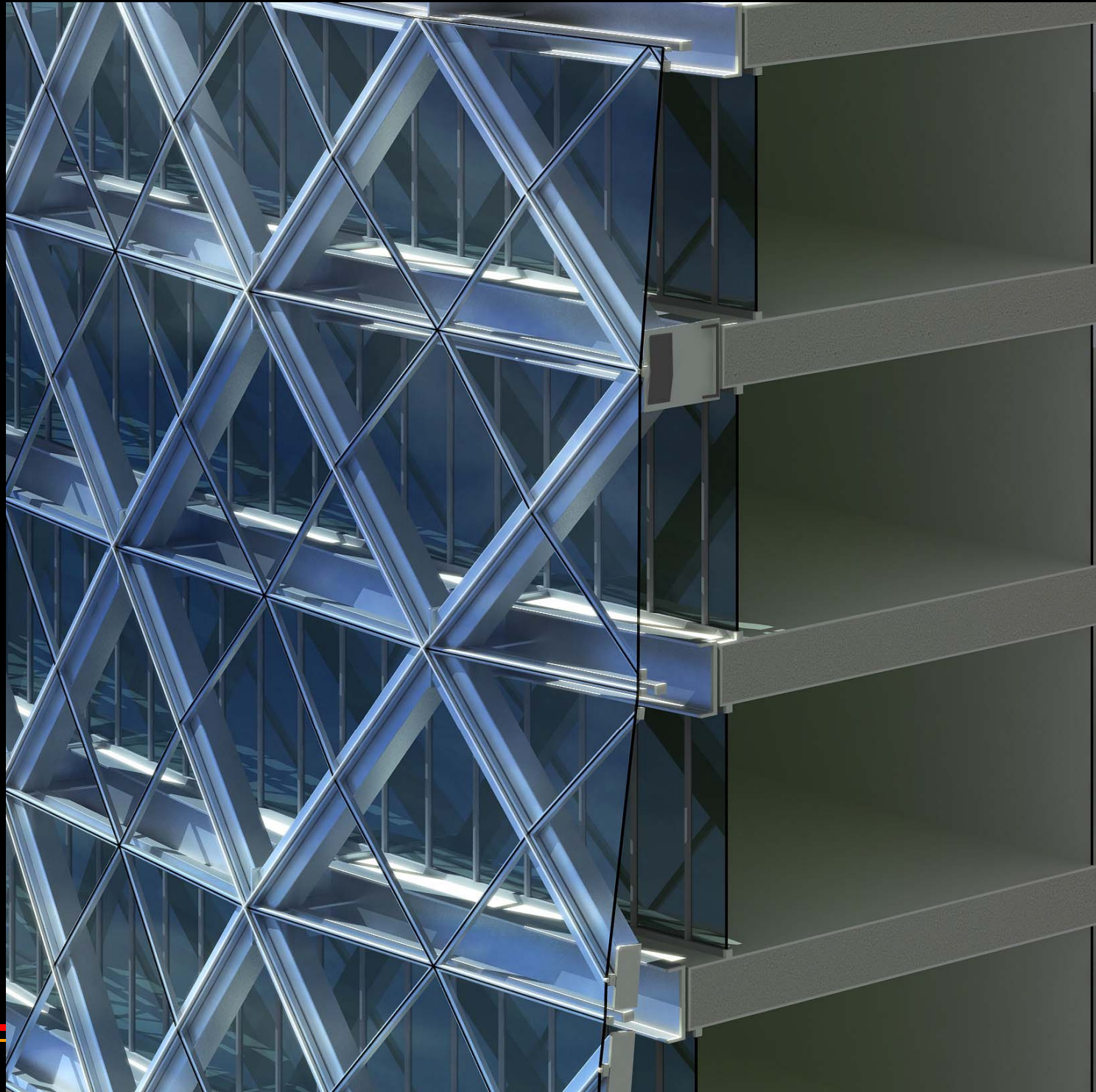

Sun's Rays at 12:00 Noon
South-South East



Sun's Rays at 16:00 PM
South-South West



Sun's Rays at 9:00 AM
South East



88 degrees

45 degrees

20 degrees

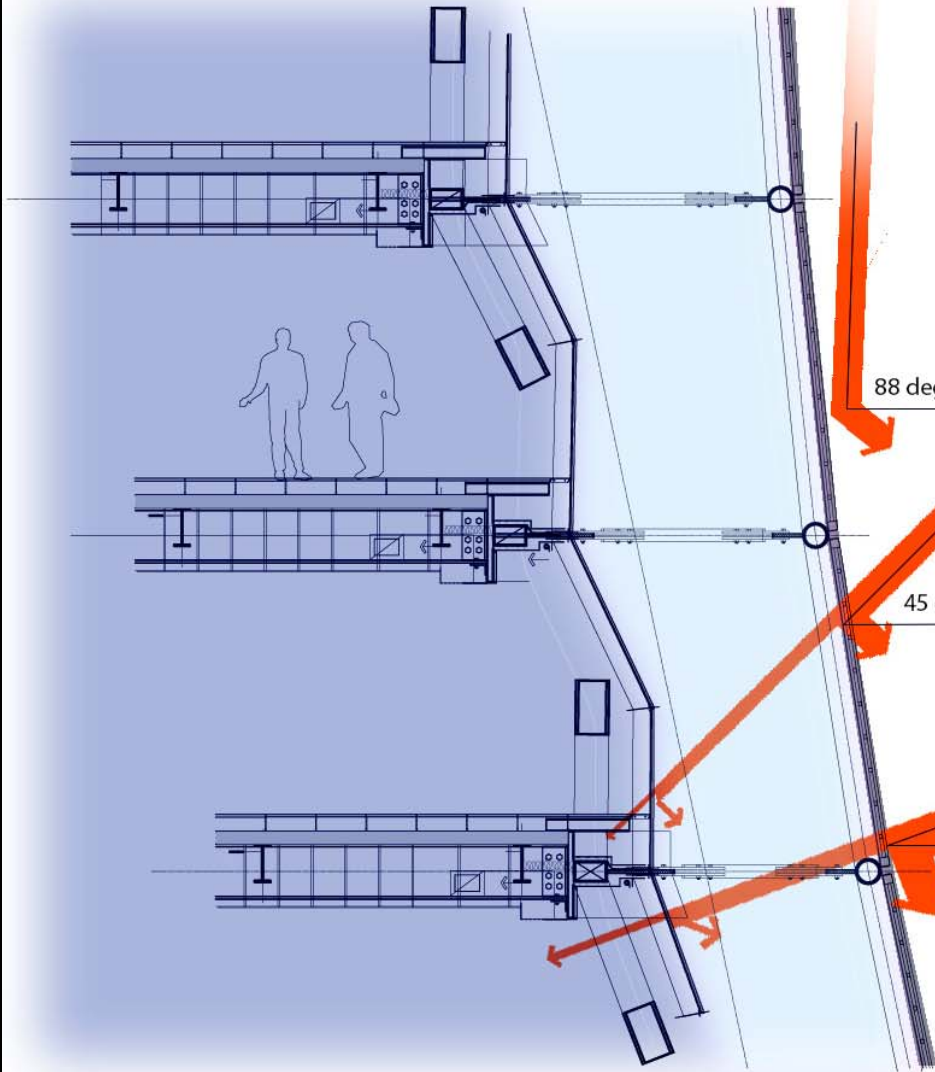



Looking to the Future:

Double Skins and Environmental Design:

The key “green” strategies of double façade buildings are noted as:

- provision of natural ventilation
- control of solar heat gain
- high levels of daylighting
- provision and protection of shading devices
- reduction in reliance on and size of mechanical systems
- high level of occupant comfort

References:

“Double-Skin Façades: Integrated Planning.” Oesterle, Lieb, Lutz, Heusler. Prestel, 2001.

■ “Intelligent Skins.” Michael Wigginton + Jude Harris. Gray Publishing, 2002.

■ “The Technology of Ecological Building.” Klaus Daniels. Birkhauser, 1997.

■ “Bioclimatic Skyscrapers: Hamzah & Yeang.” T.R. Hamzah + Yeang Sdn. Bhd. Ellipsis. 1994.

■ “Sustainable Architecture and High Technology: Eco-Tech.” Catherine Slessor. 1997/2001.

■ “The Green Skyscraper.”

