

Arch 172: Building Construction 1

Soils, Surveying, Excavation & Foundations



1960

The Architect

Alvin Kober

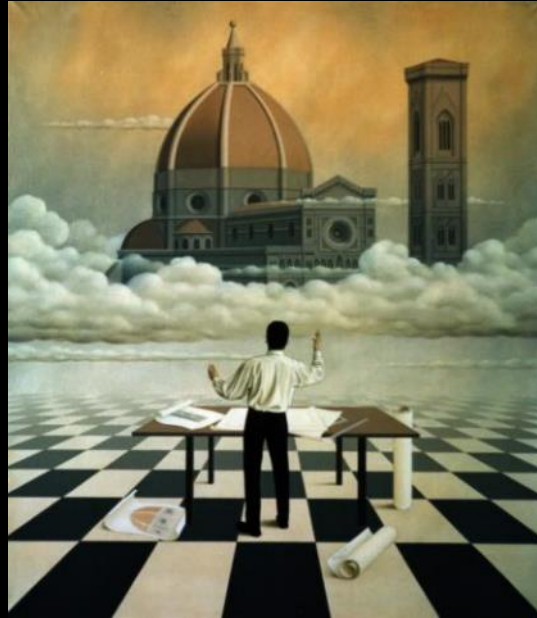

BOSTON
DAYTON & WENTWORTH,
MADE.



Only one building in the world is allowed to be famous for having a bad foundation design.

美丽的
莲花河畔景苑大楼
是怎样倒塌的

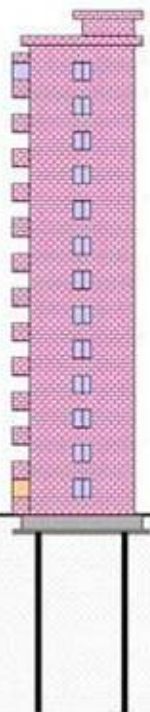

SINA 新浪论坛
bbs.sina.com.cn

莲花河畔景苑施工方案
先造楼，后造地下车库

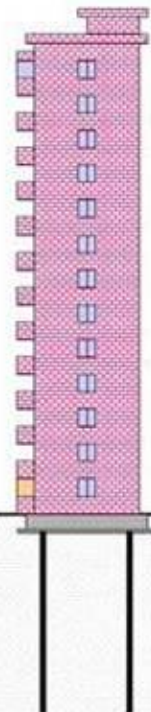

堆土挤打
SINA 新浪论坛
bbs.sina.com.cn

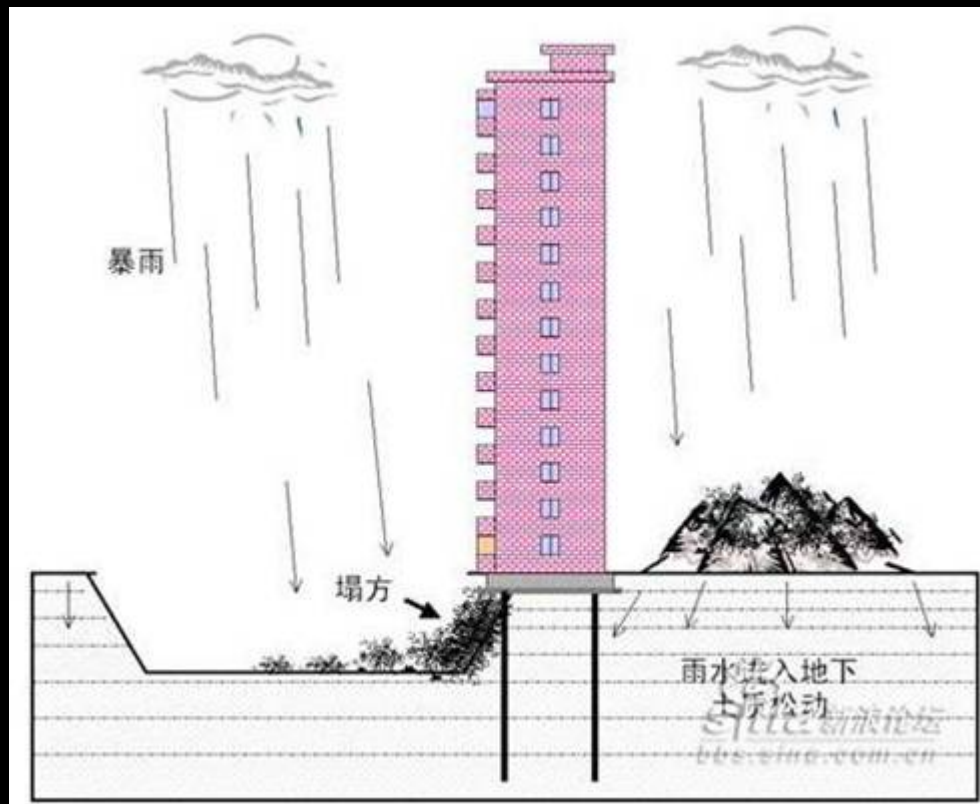

More on this one later...

Surveying



RECORD OF SURVEY
 LOCATED IN THE NE 1/4 OF SW 1/4
 SECTION 19, TOWNSHIP 17 NORTH, RANGE 3 EAST, WILLAMETTE MERIDIAN
 THURSTON COUNTY, WASHINGTON

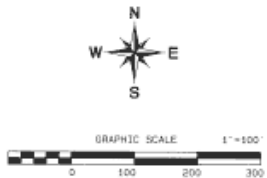

- LEGEND:**
- (P1) MCKENZIE'S ADDITION TO TOWN OF YELM, THURSTON CO., WASHINGTON.
 - (CP1) MCKENZIE'S ADDITION TO TOWN OF YELM, THURSTON CO., WASHINGTON CALCULATED.
 - (P2) MCKENZIE'S SECOND ADDITION TO YELM, WASHINGTON.
 - (CP2) MCKENZIE'S SECOND ADDITION TO YELM, WASHINGTON CALCULATED.
 - (R1) ROS #1074990, VOL. 10, PG. 140
 - (R2) ROS #9310180025, VOL. 10, PG. 9
 - (R3) ROS #890260030, VOL. 24, PG. 153
 - (R4) ROS #930100253, VOL. 31, PG. 160
 - (R5) SS #600310157, VOL. 26, PG. 389
 - (R6) ROS #3008714
 - (M) MEASURED
 - (P6) PROPORTIONED
 - (C) CALCULATED



- ① FOUND 3/4" IRON PIPE, FILLED WITH CONCRETE, WITH NAIL, DOWN 0.5', APPROXIMATELY 1 NELY X 2' SELY OF AS-BUILT INTERSECTION.
- ② FOUND 3" DIA. DOMED BRASS DISK (T.C. MONUMENT) STAMPED: "EPS 362" WITH LARGE PK STRADDLES, APPROXIMATELY 7' SWLY OF AS-BUILT INTERSECTION.
- ③ FOUND BRASS PIN UP 1/2", SET IN CONCRETE IN 2" (OD) IRON PIPE, DOWN 0.4', IN IRON CASE, AT AS-BUILT INTERSECTION.
- ④ FOUND 2" DIA. BRASS DISK STAMPED WITH 1/2" WIDE "X", SET IN CONCRETE, DOWN 0.2', APPROXIMATELY 2.5 SELY OF AS-BUILT INTERSECTION.
- ⑤ FOUND 2" DIA. BRASS DISK STAMPED WITH 1/2" WIDE "X", SET IN CONCRETE, DOWN 0.2', AT AS-BUILT INTERSECTION.
- ⑥ FOUND 5/8" REBAR FLUSH WITH ROAD SURFACE, AT AS-BUILT INTERSECTION.
- ⑦ FOUND CONCRETE NAIL WITH FENDER WASHER AT ROAD SURFACE AT AS-BUILT INTERSECTION.
- ⑧ CONCRETE NAIL WITH FENDER WASHER KNOWN BY THIS SURVEYOR TO BE TYPICALLY SET FOR LANCE KEYS, PLS.
- ⑨ FOUND 5/8" REBAR WITH YELLOW CAP STAMPED: "KEYS L816R10", AT RECORD POSITION.
- ⑩ FOUND 2" BRASS DISK WITH "X", STAMPED: "22346", SET IN CONCRETE AT ROAD SURFACE, APPROXIMATELY 3' SWLY OF AS-BUILT INTERSECTION.
- ⑪ FOUND 2" BRASS DISK WITH "X", STAMPED: "22346", SET IN CONCRETE AT ROAD SURFACE, AT AS-BUILT INTERSECTION.

LINE	BEARING	DISTANCE	RECORD
L1	S82°37'59"E	300.50'	(R2) 28°00'E 100.00' (P1)
L2	N08°18'20"W	150.45'	(R2) 28°00'E 100.00' (P1)
L3	S82°38'49"W	300.44'	(R2) 28°00'E 100.00' (P1)
L4	S99°38'45"E	121.13'	(R2) 28°00'E 100.00' (P1)
L5	S28°38'49"E	300.39'	(R2) 28°00'E 100.00' (P1)
L6	N02°30'24"W	150.33'	(R2) 28°00'E 100.00' (P1)
L7	S82°38'24"E	300.33'	(R2) 28°00'E 100.00' (P1)
L8	N02°30'04"W	150.38'	(R2) 28°00'E 100.00' (P1)
L9	S37°21'56"W	309.77'	(R1) (P1)
L10	S89°38'45"E	87.32'	(R2) 28°00'E 100.00' (P1)
L11	S82°38'49"E	298.44'	(R2) 28°00'E 100.00' (P1)
L12	S49°14'00"W	132.82'	(R4) 28°00'E 100.00' (P1)
L13	S82°38'45"E	86.89'	(R2) 28°00'E 100.00' (P1)
L14	S99°38'44"E	85.86'	(R2) 28°00'E 100.00' (P1)
L15	S37°14'44"W	129.01'	(R1) 28°00'E 100.00' (P1)
L16	S49°14'06"W	132.79'	(R4) 28°00'E 100.00' (P1)
L17	S82°38'45"W	182.34'	(R2) 28°00'E 100.00' (P1)

0-28-01

SHEET ONE OF TWO

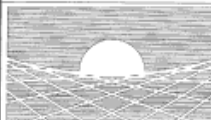

Geomatics, P.S., Inc.
 Geomatics Land Surveying
 104 Berry Valley Road
 P.O. Box 2540, Yelm, Washington 98597-2550
 360.400.LAND (5263) fax 360.400.5264
 drb@geomaticslandsurveying.com



SURVEYOR'S CERTIFICATE
 THIS MAP CORRECTLY REPRESENTS A SURVEY MADE BY ME OR UNDER MY DIRECTION, IN CONFORMANCE WITH THE REQUIREMENTS OF SURVEYING ACT AS AT THE REQUEST OF CLIENTS ENCLOSED IN LINE OF 2001.

DAVID RAY BAEER
 LS 11019 (2011) SURVEYOR

AUDITOR'S CERTIFICATE
 FILED FOR RECORD THIS 28th DAY of August 2001 AT THE REQUEST of Erling Barkland

AUDITOR'S FEE NO. 33751013

Erling Barkland
 COUNTY AUDITOR

RECORD OF SURVEY FOR: YELM COMMUNITY SCHOOLS

DRAWN BY: DRB
 CHECKED: DRB
 SCALE: AS SHOWN
 JOB NO: 1021
 DATE: AUGUST 24, 2001
 COPYRIGHT: © 2001, GEOMATICS, P.S., INC.

PLAN OF SURVEY

SCALE: 1" = 20'

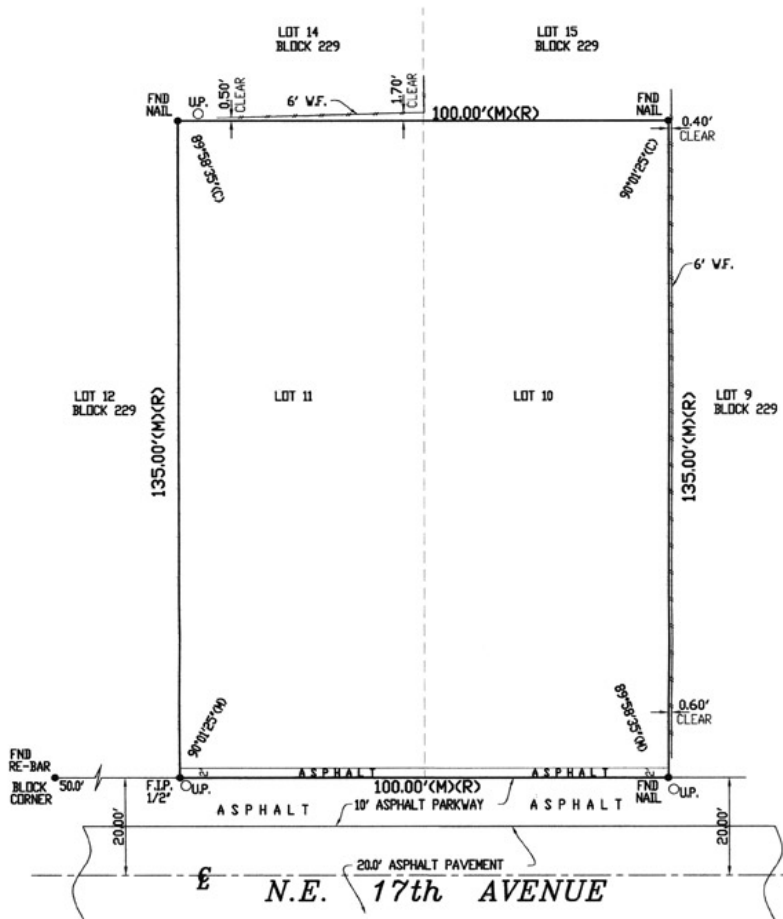

RECORD OF SURVEY
 LOCATED IN THE NE 1/4 OF SW 1/4
 SECTION 19, TOWNSHIP 17 NORTH, RANGE 2 EAST, WILLAMETTE MERIDIAN
 THURSTON COUNTY, WASHINGTON

SURVEYOR'S NOTES:

- BEARING DATUM: MCKENZIE'S SECOND ADDITION TO YELM, WA.
- BASIS OF BEARING: BRASS DISKS AT THE INTERSECTIONS OF N 1ST ST WITH NE JEFFERSON AVE AND NE VAN TRUMP AVE.
- METHOD OF MONUMENT LOCATION WAS BY FIELD TRAVERSE.
- INSTRUMENT UTILIZED: GEODIMETER SYSTEM 6005 D92000.
- THE FIELD SURVEY WAS CONDUCTED IN JUNE AND JULY, 2001.
- THE LOT CORNERS WERE SET JULY 6, 2001.
- THE STREET AND AVENUE NAMES ARE FROM THE ROAD BURNED, THURSTON COUNTY STREET ATLAS - 2000 EDITION.
- ALL OR A PORTION OF PARCEL "A" (TAX PARCEL'S #4400100100 AND #4421000100) IS SUBJECT TO A UTILITY EASEMENT FOR SANITARY SEWER SYSTEM PURPOSES, RECORDED UNDER THURSTON COUNTY AUDITOR'S FEE NO. 2: 020390003 AND 040310004. THE LOCATION OF SAID UTILITY EASEMENT WAS NOT DETERMINE THIS SURVEY.
- HELD ROS #8351080025, DISTANCE OF 101.83' FROM FOUND MONUMENT AT THE INTERSECTION OF YELM AVE WITH 1ST ST, ON LINE WITH THE FOUND MONUMENT AT THE INTERSECTION OF YELM AVE WITH NW SLOBERG ST, ALONG WITH THE ANGLE OF 101°07'33" FOR THE CENTERLINE OF THE RAILROAD RIGHT OF WAY, AND THE DISTANCE OF 50' PERPENDICULAR TO AND PARALLEL WITH SAID ESTABLISHED CENTERLINE FOR RIGHT OF WAY LIMITS.
- HELD THE BEARING FROM THE FOUND MONUMENT AT THE INTERSECTION OF YELM AVE WITH 2ND ST, PROJECTED THROUGH THE FOUND MONUMENT AT THE INTERSECTION OF YELM AVE WITH 1ST ST, AND THE DISTANCE OF 30' PERPENDICULAR TO AND PARALLEL WITH SAID ESTABLISHED BEARING FOR NORTHERLY RIGHT OF WAY/SOUTHERLY LIMITS OF BLOCK 1 OF MCKENZIE'S FIRST ADDITION, AS WAS DONE FOR THE SOUTHERLY RIGHT OF WAY/SOUTHERLY LIMITS OF BLOCK 2 OF MCKENZIE'S FIRST ADDITION FOR ROS #2002100223104) AND ROS #3009714106).
- THIS SURVEY WAS PERFORMED TO LOCATE ALL OR A PORTION OF THE EXTERIOR BOUNDARY LINES OF THE DESCRIBED PARCEL AND DOES NOT NECESSARILY SHOW ANY OF ALL EASEMENTS, RESTRICTIONS AND/OR RESERVATIONS WHICH MAY AFFECT THIS PARCEL. GEOMATICS, P.S., INC. ASSUMES NO RESPONSIBILITY FOR ANY ENCUMBRANCES OTHER THAN THOSE SHOWN.
- THIS SURVEY MEETS OR EXCEEDS THE STANDARDS AND GUIDELINES SET FORTH IN THE "SURVEY RECORDING ACT" CHAPTER 82B RCW. THE FINAL RESULTS MEETS OR EXCEEDS THE STANDARDS CONTAINED IN WAC 330-140-090.
- THIS DRAWING IS THE PROPERTY OF GEOMATICS, P.S., INC. AND SHALL NOT BE USED FOR ANY PURPOSE WITHOUT THE WRITTEN CONSENT OF AN AUTHORIZED AGENT OF GEOMATICS, P.S., INC. GEOMATICS, P.S., INC. ACCEPTS NO RESPONSIBILITY FOR THE USE OF THIS DRAWING FOR ANY PURPOSE AFTER SIX MONTHS FROM THE RECORDING DATE.
 ©2001, GEOMATICS, P.S., INC.

LEGEND:

- SET 1/2" DIA. REBAR WITH GRANGE CAP STAMPED "GEOMATICS P.S. 19972" (TYPICAL REBAR)
- SET 2" W/ 1-1/2" W/ASHER STAMPED "GEOMATICS 35972" (TYPICAL PK)
- FENCE: 6' CHAIN-LINK
- FENCE: 3' IRON PIPE
- ▭ BUILDING
- EDGE OF PAVEMENT
- ▭ ROCK RETENTION WALL
- ▭ CONCRETE
- ▭ ASPHALT
- ▭ GRAVEL LIMITS

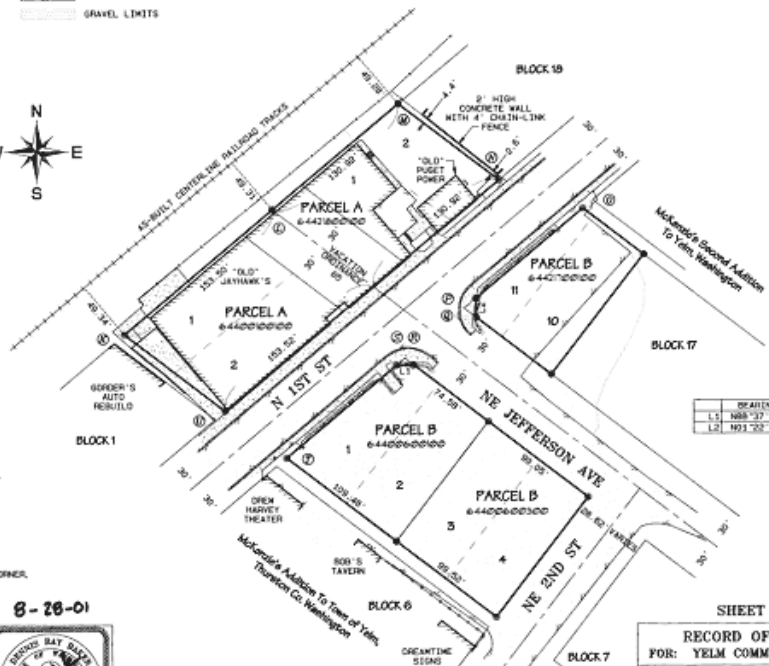

BEARING	DISTANCE
L1: N88°37'41"E	13.61'
L2: N01°32'22"W	10.05'

LAND DESCRIPTION:

PARCEL A:
 LOTS 1 AND 2 OF BLOCK 1, OF MCKENZIE'S FIRST ADDITION TO YELM, AS RECORDED IN VOLUME 8 OF PLATS, PAGE 36; AND LOTS 1 AND 2 OF BLOCK 18, OF MCKENZIE'S SECOND ADDITION TO YELM, AS RECORDED IN VOLUME 8 OF PLATS, PAGE 104, TOGETHER WITH THAT PORTION OF JEFFERSON STREET VACATED UNDER ORDINANCE NO. 65, LYING BETWEEN SAID BLOCKS.

PARCEL B:
 LOTS 1, 2, 3 AND 4, BLOCK 6, MCKENZIE'S FIRST ADDITION AS RECORDED IN VOLUME 8 OF PLATS, PAGE 26, AND LOTS 10, 11, BLOCK 17, MCKENZIE'S SECOND ADDITION AS RECORDED IN VOLUME 8 OF PLATS, PAGE 104, EXCEPT THAT PORTION OF LOTS 1 AND 11 CONVEYED TO THE TOWN OF YELM BY DEED RECORDED MAY 10, 1990 UNDER FILE NO. 9005100142.

IN THURSTON COUNTY WASHINGTON,
 SUBJECT TO EASEMENTS, RESTRICTIONS AND RESERVATIONS OF RECORD,
 THE ABOVE LAND DESCRIPTION WAS MODIFIED FROM THURSTON COUNTY TITLE COMPANY, ORDER NO.: 117270, ALTA COMMITMENT, SCHEDULE A, WITH THE EFFECTIVE DATE OF JULY 6, 2001 AT 8:00 A.M.

- Ⓢ DRILLED HOLE IN CONCRETE, SET TYPICAL PK 4.1" WELY X 0.1" SELY OF EDGE, 10.7" FROM HELY EDGE OF GARDEN'S BUILDING.
- Ⓢ SET TYPICAL REBAR IN GROUND, 2.9" WELY OF EDGE OF BUILDING, 13.0" SELY OF 6' CHAIN-LINK FENCE.
- Ⓢ SET TYPICAL REBAR IN GRAVEL, 11.2" SELY X 5.1" SWLY OF 6' CHAIN-LINK FENCE.
- Ⓢ SET TYPICAL PK IN ASPHALT, 3.4" SELY X 2.6" SWLY OF CONCRETE WALL CORNER, 5.8" WELY OF BACK OF CONCRETE WALK.
- Ⓢ SET TYPICAL PK IN ASPHALT, 5.0" SELY OF BACK OF CONCRETE WALK.
- Ⓢ DRILLED HOLE IN CONCRETE, SET TYPICAL PK 0.2" WELY OF BACK OF CONCRETE WALK.
- Ⓢ SET TYPICAL PK IN ASPHALT, AT T/OE OF ROCK RETENTION WALL, 2.5" SELY OF BACK OF CONCRETE WALK.
- Ⓢ DRILLED HOLE IN ROCK, SET TYPICAL PK 1.6" SELY OF BACK OF CONCRETE WALK.
- Ⓢ DRILLED HOLE IN ROCK, SET TYPICAL PK 2.0" SELY OF BACK OF CONCRETE WALK.
- Ⓢ SET TYPICAL PK IN ASPHALT, 5.0" SELY OF BACK OF CONCRETE WALK.
- Ⓢ DRILLED HOLE IN CONCRETE, SET TYPICAL PK 5.2" WELY X 2.3" SWLY OF BUILDING CORNER, 1.2" SELY OF BACK OF CONCRETE WALK.

8 - 28 - 01

Geomatics, P.S., Inc.

Geomatics Land Surveying
 104 Berry Valley Road
 P.O. Box 2150, Yelm, Washington 98597-2150
 360.400.LAND (5263) fax 360.400.5264
 dl@geomaticslandsurveying.com

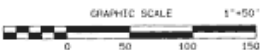

SHEET TWO OF TWO

RECORD OF SURVEY
 FOR: YELM COMMUNITY SCHOOLS

DRAWN BY:	DRB
CHECKED BY:	DRB
SCALE:	AS SHOWN
JOB NO:	5021
DATE:	AUGUST 24, 2001
COPYRIGHT:	© 2001, GEOMATICS, P.S., INC.

Prepared for and certified only to:
 JACK C. MAY
 SUE B. MAY
 THEIR NATIONAL BANK
 THEIR TITLE INSURANCE CO.

$$\text{AREA} = \frac{10,969 \text{ Sq. Ft.}}{0.251 \text{ Acres}}$$

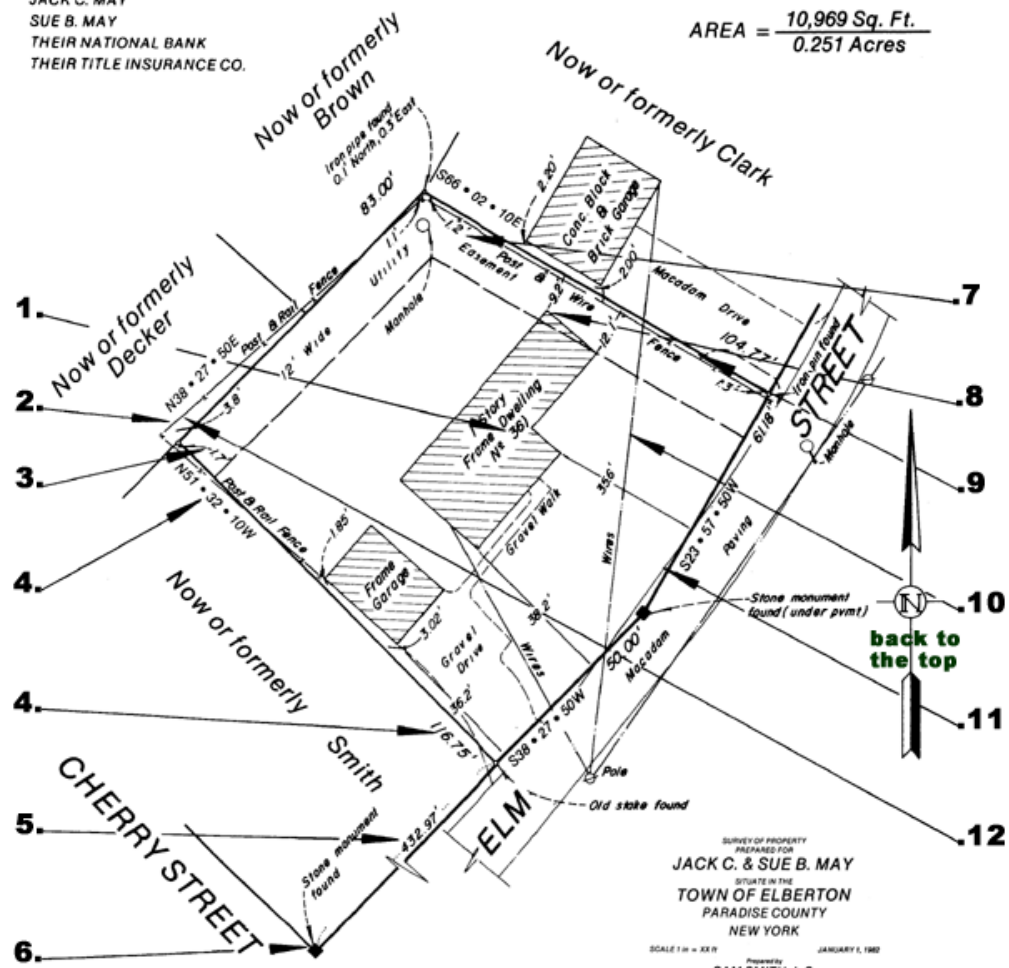

SURVEY OF PROPERTY
 PREPARED FOR
 JACK C. & SUE B. MAY
 SITUATE IN THE
 TOWN OF ELBERTON
 PARADISE COUNTY
 NEW YORK

SCALE 1" = 33' JANUARY 1, 1982

Prepared by
 SAM SMITH, L.S.

Sam Smith

N.Y.S. LICENSE NO. 0020



STATE ROUTE 37

VILLAGE OF GRANVILLE, OHIO
794 - 317

30.06' 382°04'50"E 342.32' 392.38' (T)

GRANVILLE FINANCIAL CENTER
31 - 982
Tr. 1

CONT. 5.221 AC. ±

GRANVILLE FINANCIAL CENTER
840 - 419

Tr. 2
Par. 1

JACK T. & JUDITH B. FEID
788 - 801

E CURVE DATA

M	R	E	F	Δ	A	CHORD
1	5729.50	0.04	20.31	0°24'22"	40.61'	N5°10'43"E 40.51'
2	40926	1.00	28.61	7°59'46"	37.12'	N38°58'09"W 37.07'

- LEGEND -
- - IRON PIN FOUND
 - - IRON PIN SET
 - △ - RAILROAD SPIKE

TOWNSHIP ROAD 131

PT. STA. 375 + 60.39

STATE ROUTE 37

- PREPARED BY -
JONES, HENDERSON & ASSOC., INC.
1649 GRANVILLE RD.
NEWARK OHIO 43055

William B. Henderson
WILLIAM B. HENDERSON
P.E. #2442



HAROLD C. PARKER
473 - 645

PT. STA. 214+57.55

TOWNSHIP ROAD 131

JOHN E. & ALICE L. SPRAY
844 - 24

PLAT FOR
GRANVILLE FINANCIAL
CENTER SURVEY
TOWNSHIP OF GRANVILLE
COUNTY OF LICKING
OHIO
BEING PART OF LOTS 14 & 15
3/4 QTR, T-2, R-13
U.S.M.L.
SCALE: 1"=50'
DATE: FEBRUARY, 1990

FILE: 90-08

Soils



....pst....wanna buy some cheap swampland in Florida?

PRESUMPTIVE SURFACE BEARING VALUES OF FOUNDATION MATERIALS

Class of material	Tons per square foot
1. Massive crystalline bedrock including granite, diorite, gneiss, trap rock, hard limestone and dolomite	100
2. Foliated rock including bedded limestone, schist and slate in sound condition	40
3. Sedimentary rock including hard shales, sandstones, and thoroughly cemented conglomerates	25
4. Soft or broken bedrock (excluding shale), and soft limestone	10
5. Compacted, partially cemented gravels, and sand and hardpan overlying rock	10
6. Gravel and sand gravel mixtures	6
7. Loose gravel, hard dry clay, compact coarse sand, and soft shales	4
8. Loose, coarse sand and sand-gravel mixtures and compact fine sand (confined)	3
9. Loose medium sand (confined), stiff clay	2
10. Soft broken shale, soft clay	1.5

Note 1 ton per square foot = 9765 kg/m².

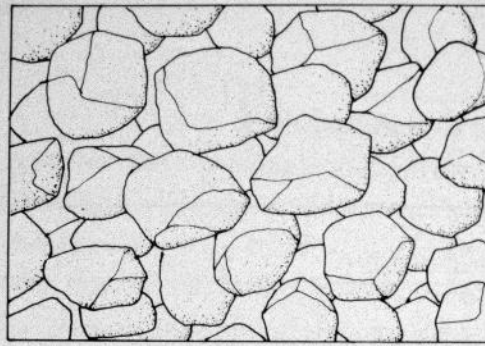

Silt Particles

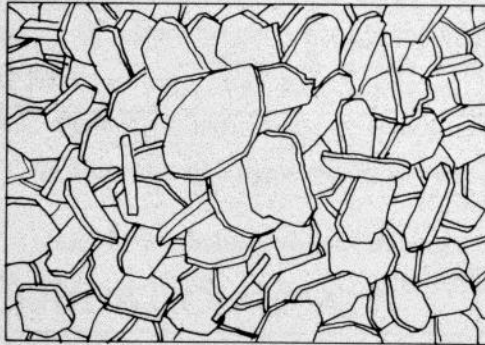

Clay Particles

FIGURE 2.3

Silt particles (top) are approximately equidimensional granules, while clay particles (bottom) are platelike and generally much smaller than silt. The clay structure shown here is flocculated. In some other types of clays the particles lie in parallel relationships, either more closely packed, or dispersed by electrostatic forces.



Silty soil



Clay



Clay soil



sandy soil

Sandy soil



Pea Gravel



Clean Gravel



Gravel with fines

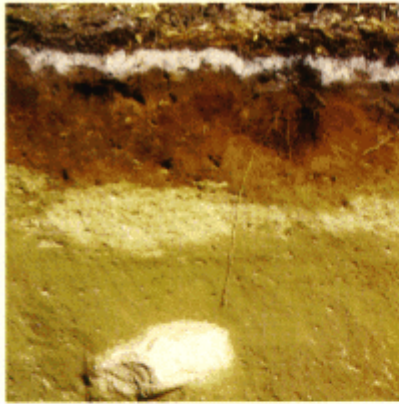

20



21

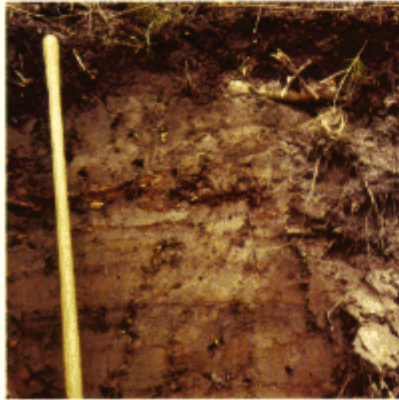

22

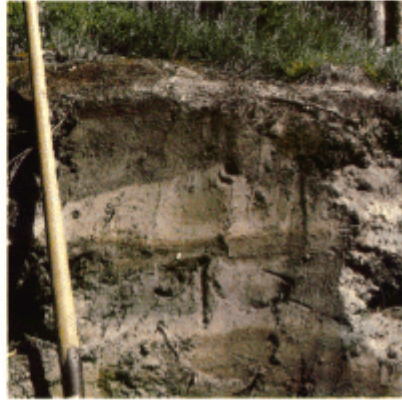

23



We need to find out what the
make up of the soil
composition on our site is.

How do we go about doing
that?

FIGURE 2.2

A soil classification chart based on the Unified Soil Classification System. The group symbols are a universal set of abbreviations for soil types, as used in Figure 2.7.

		Group Symbols		Typical Names
Course-grained Soils	Gravels		GW	Well-graded gravels, gravel-sand mixtures, little or no fines
		Clean Gravels	GP	Poorly graded gravels, gravel-sand mixtures, little or no fines
	Sands	Gravels with Fines	GM	Silty gravels, poorly graded gravel-sand-silt mixtures
		Gravels with Fines	GC	Clayey gravels, poorly graded gravel-sand-clay mixtures
	Sands	Clean Sands	SW	Well-graded sands, gravelly sands, little or no fines
		Sands with Fines	SP	Poorly graded sands, gravelly sands, little or no fines
	Fine-grained Soils	Sands with Fines	SM	Silty sands, poorly graded sand-silt mixtures
			SC	Clayey sands, poorly graded sand-clay mixtures
		Sifts and Clays (Liquid limit greater than 50)	ML	Inorganic silts and very fine sands, rock flour, silty or clayey fine sands with plasticity
			CL	Inorganic clays of low to medium plasticity, gravelly clays, sandy clays, silty clays, lean clays
OL			Organic silts and organic silt-clays of low plasticity	
Sifts and Clays (Liquid limit less than 50)		MH	Inorganic silts, micaceous or diatomaceous fine sandy or silty soils, elastic silts	
		CH	Inorganic clays of high plasticity, fat clays	
	OH	Organic clays of medium to high plasticity		
Highly Organic Soils	Pt	Peat and other highly organic soils		

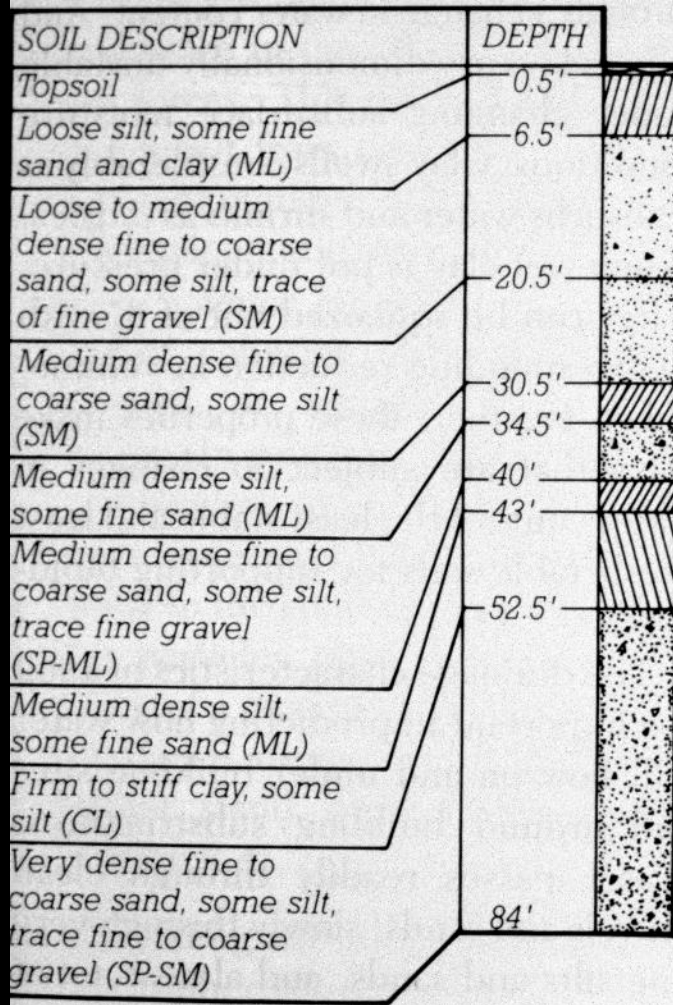

FIGURE 2.7

A typical log from a soil test boring, indicating the type of soil in each stratum and the depth in feet at which it was found. The abbreviations in parentheses refer to the Unified Soil Classification System, and are explained in Figure 2.2.

Unified Soil Classification System

Adapted from [Basic Soils Engineering](#)

B.K. Hough copyright 1957 The Ronald Press Company

Major Divisions			Pattern	Code	Description	
COARSE GRAINED SOILS	GRAVEL AND GRAVELLY SOILS	CLEAN GRAVELS (little or no fines)		GW	Well-graded gravels or gravel-sand mixtures, little or no fines	
				GP	Poorly graded gravels or gravel-sand mixtures, little or no fines	
		More than half of coarse fraction is larger than No. 4-sieve size.	GRAVELS WITH FINES (applicable amount of fines)		GM	Silty gravels, gravel-sand-silt mixtures
				GC	Clayey gravels, gravel-sand-clay mixtures	
	More than half of material is larger than No. 200-sieve size.	SAND AND SANDY SOILS	CLEAN SANDS (little or no fines)		SW	Well-graded sands or gravelly sands, little or no fines
					SP	Poorly graded sands or gravelly sands, little or no fines
More than half of coarse fraction is smaller than No. 4-sieve size.			SAND WITH FINES (applicable amount of fines)		SM	Silty sands, sand-silt mixtures
				SC	Clayey sands, sand-clay mixtures	
FINE GRAINED SOILS		SILTS AND CLAYS	Liquid limit less than 50		ML	Inorganic silts and very fine sands, rock flour, silty or clayey fine sands, or clayey silts with slight plasticity
					CL	Inorganic clays of low to medium plasticity
				OL	Organic silts and organic silt-clays of low plasticity	
	More than half of material is smaller than No. 200-sieve size.	Liquid limit greater than 50		MH	Inorganic silts, micaceous or diatomaceous fine sandy or silty soils, elastic silts	
				CH	Inorganic clays of high plasticity, fat clays	
				OH	Organic clays of medium to high plasticity, organic silts	
HIGHLY	ORGANIC	SOILS		PT	Peat and other highly organic soils	

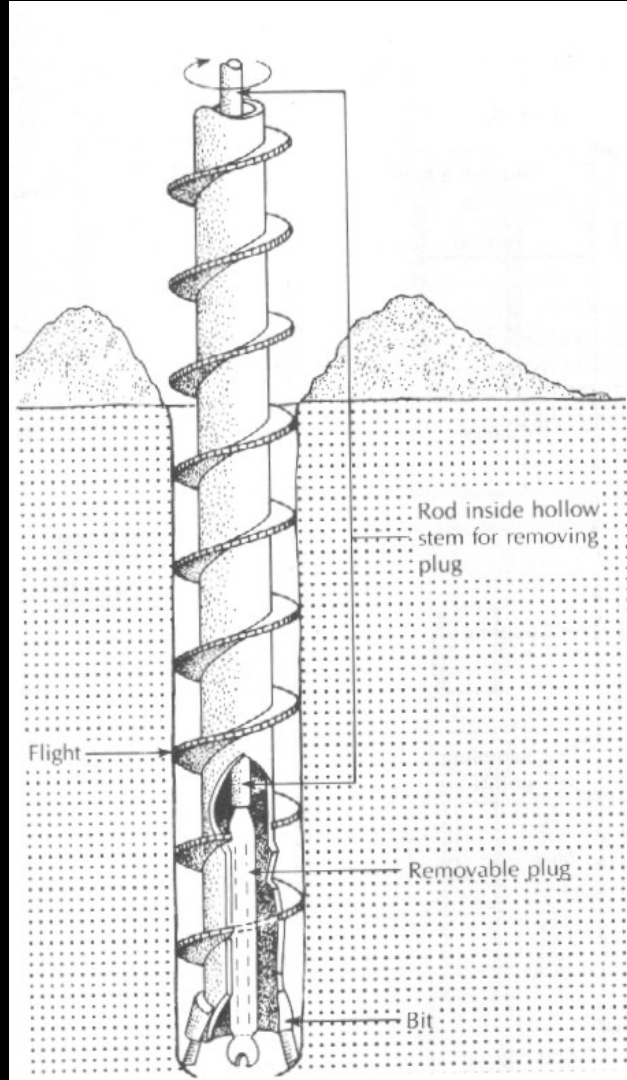



Geobor S

Atlas Copco

- THE ULTIMATE SAMPLING SYSTEM

HOLE DIAMETER $\phi 146$ mm 5 3/4"
 CORE DIAMETER $\phi 102$ mm 4"

TRIPLE TUBE CORE
 BARREL ASSEMBLY

PLASTIC LINER
 INNER TUBE
 OUTER TUBE

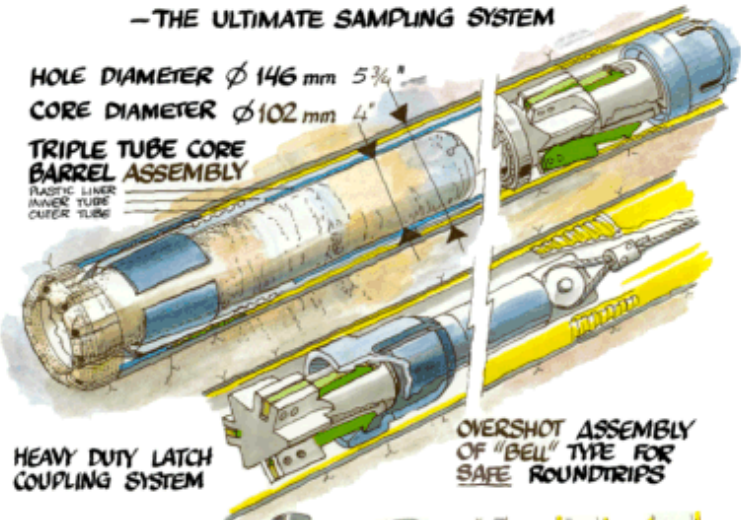

HEAVY DUTY LATCH
 COUPLING SYSTEM

OVERSHOT ASSEMBLY
 OF "BELL" TYPE FOR
 SAFE ROUNDTrips

DRY HOLE DEVICE
 FOR GUARANTEED
 LATCHING

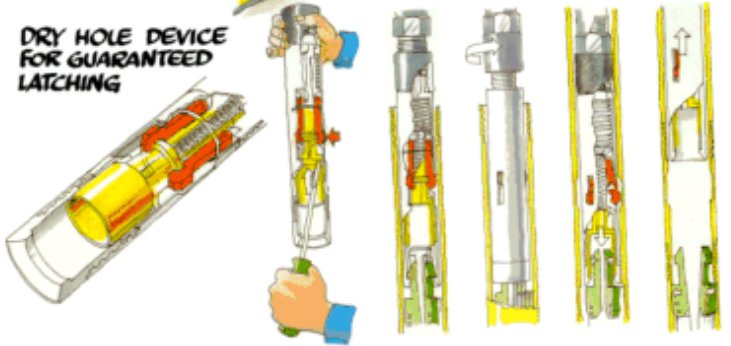

MAIN ASSEMBLIES FOR:

- CORING IN MEDIUM TO HARD FORMATIONS, METHOD I
- CORING IN SOFT FORMATIONS, METHOD II
- CORING IN VERY SOFT FORMATIONS, METHOD III
- CORING IN SOFT VARYING FORMATIONS, METHOD IV
- SHELBY SAMPLING, METHOD V
- FULL HOLE DRILLING, METHOD VI
- PACKER TEST, METHOD VII









DRILL HOLE # Sierra 1

Location Golden, Colorado
Direction Vertical
Drilling Contractor RW Drilling
Logged By JMD

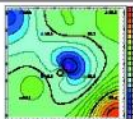

Date 6/1/00
Project No. 1364-5
Elevation 5280'
Coordinates XY
Fluid Bariod Mud

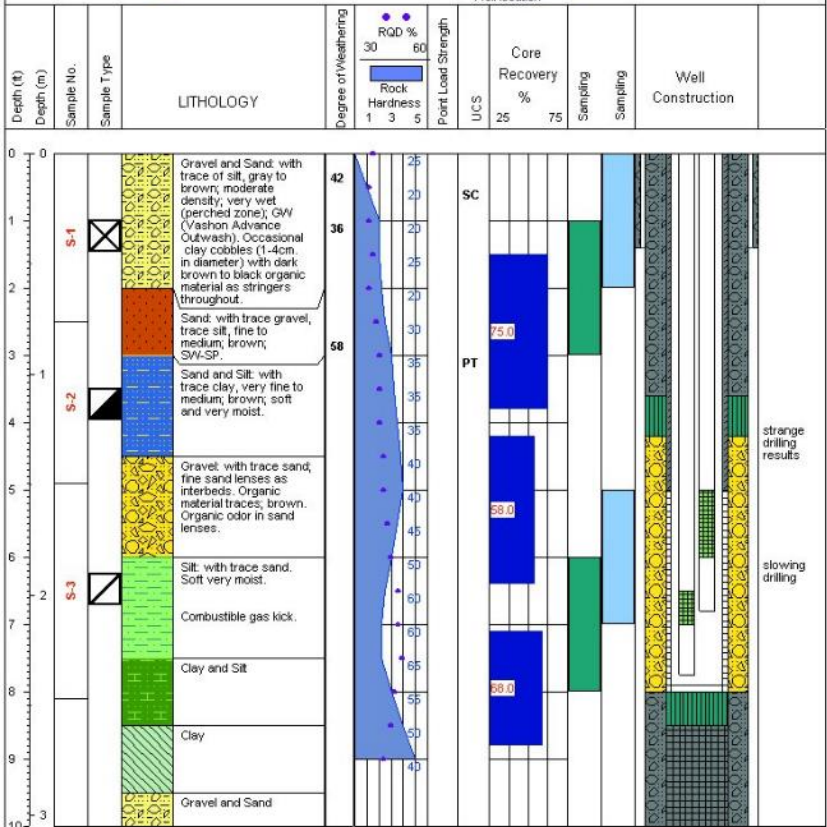

Client **RW Rock**
 Project **Hillside #1**
 Page 1 of 1

Acme Logging
 123 Main St.
 Golden, Colorado



Borehole # 02 8715
Project # 02-59
Project Name: Barker Establishment

Engineer: J Hines
Location: Elmirne Co.

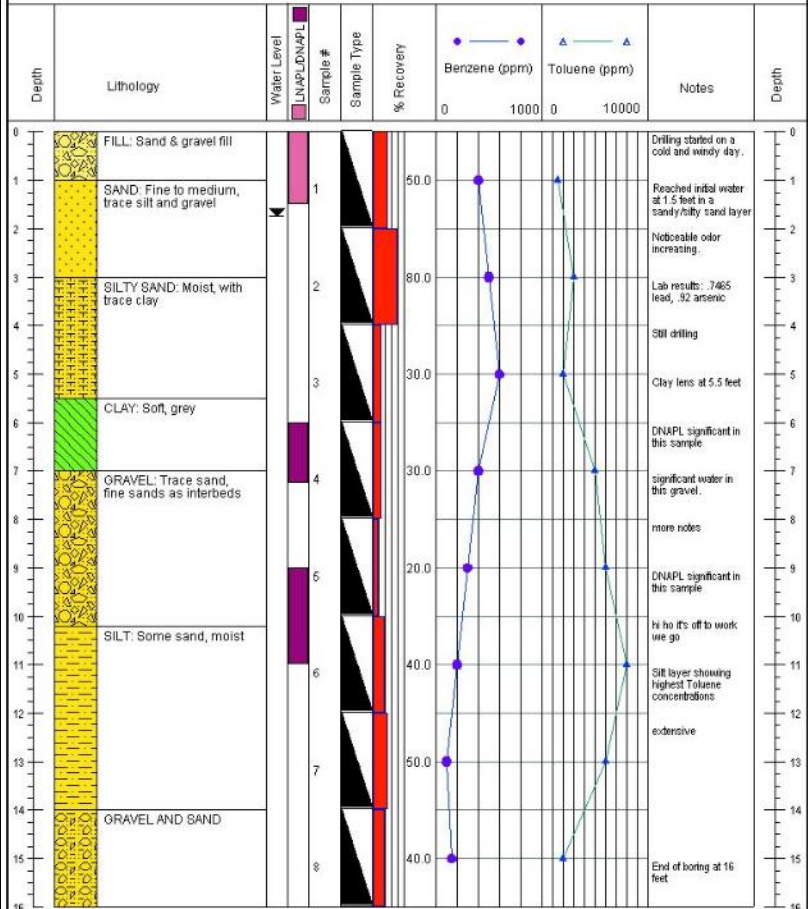

E&B Environmental

7640 Hwy 65 Cedar, WY 87365



**Great Wall
Environmental, Inc.**

**SOIL TEST BORING SYMBOLIC LOG
WITH MONITOR WELL INSTALLATION NOTES**

PROJECT: Groundwater study

DATE: 6/2/95

BORING NO. B-1

ELEVATION: 696.3

BORING LOCATION: 25N 35W

METHOD OF DRILLING: 6" Hollow Stem Auger

NOTES: Clear weather, sunny, 65°

RECORD OF WATER DEPTH CHECKS: none

CAVING DEPTH: none

ARTIFICIAL FILL DEPTH: none

ELEVATION	SOIL SYMBOLS/ FIELD TEST DATA	USCS	Soil Description	SPT "N"	SN	M %	DO per	WD per	Hyd ppm	Well Construction	Well Description
-----------	----------------------------------	------	------------------	------------	----	--------	-----------	-----------	------------	----------------------	---------------------

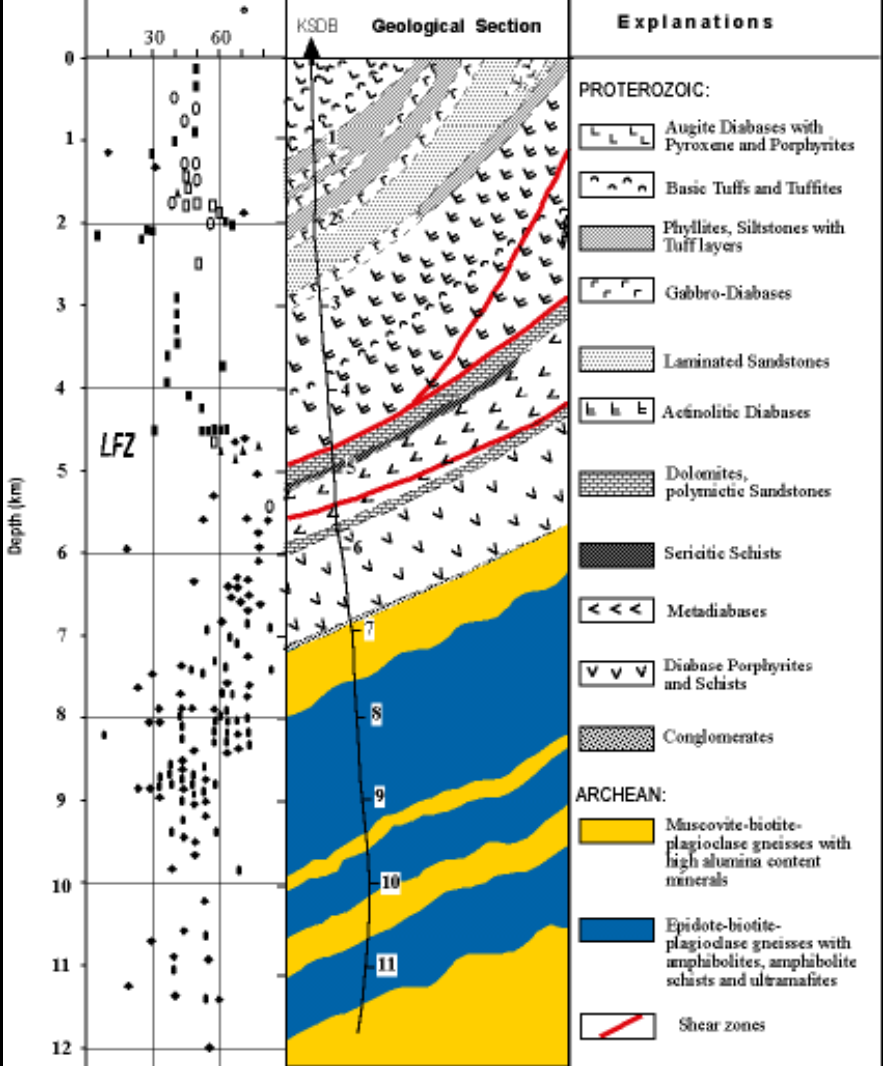
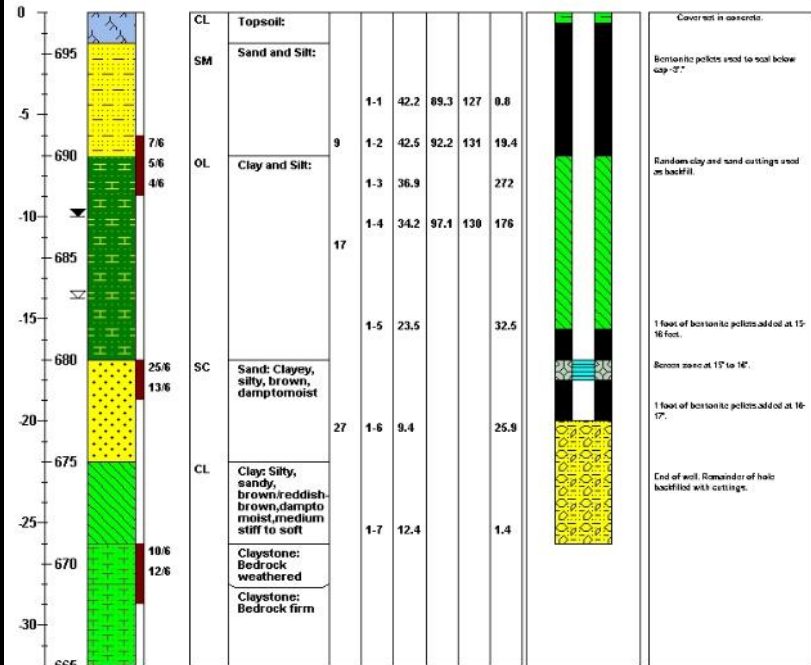

PILE TEST DATA

J1736

LOAD TONS	GAUGE PRESSURE (psi)	DATE:TIME	SETTLEMENT Inches	REMARKS
0	0	Dec. 5 12:30	0	
12.5	755	14:00	0.062	
25	1510	15:00	0.122	
37.5	2265	16:15	0.233	
50	3020	18:30	0.318	
62.5	3775	20:30	0.393	
75	4530	22:15	0.477	
87.5	5285	Dec. 6 00:15	0.552	
100	6040	00:20	Pressure	Line Broken
0	0	10:13	0.347	
50	3020	11:45	0.462	Reloading
62.5	3775	12:30	0.514	
75	4530	13:15	0.543	
87.5	5285	14:30	0.589	
100	6040	16:45	0.657	Settlement now less than .01"/hr.
100	6040	Dec. 7 14:30	0.702	Settlement after 200% design load in place 24 hours
75	4530	15:15	0.702	Unloading
50	3020	16:00	0.646	
25	1510	17:00	0.575	
0	0	Dec. 8 7:15	0.456	Test Complete

Excavations

excavation should never be deeper than waist height
so that if there is a cave in, people are not smothered

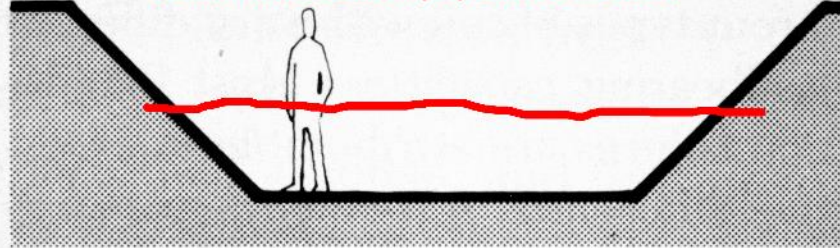

EXCAVATION IN FRICTIONAL SOIL

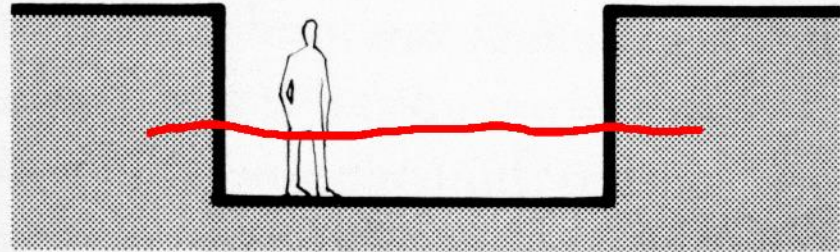

*EXCAVATION IN HIGHLY COHESIVE
SOIL*

FIGURE 2.4

*Excavations in highly cohesive and
frictional soils.*

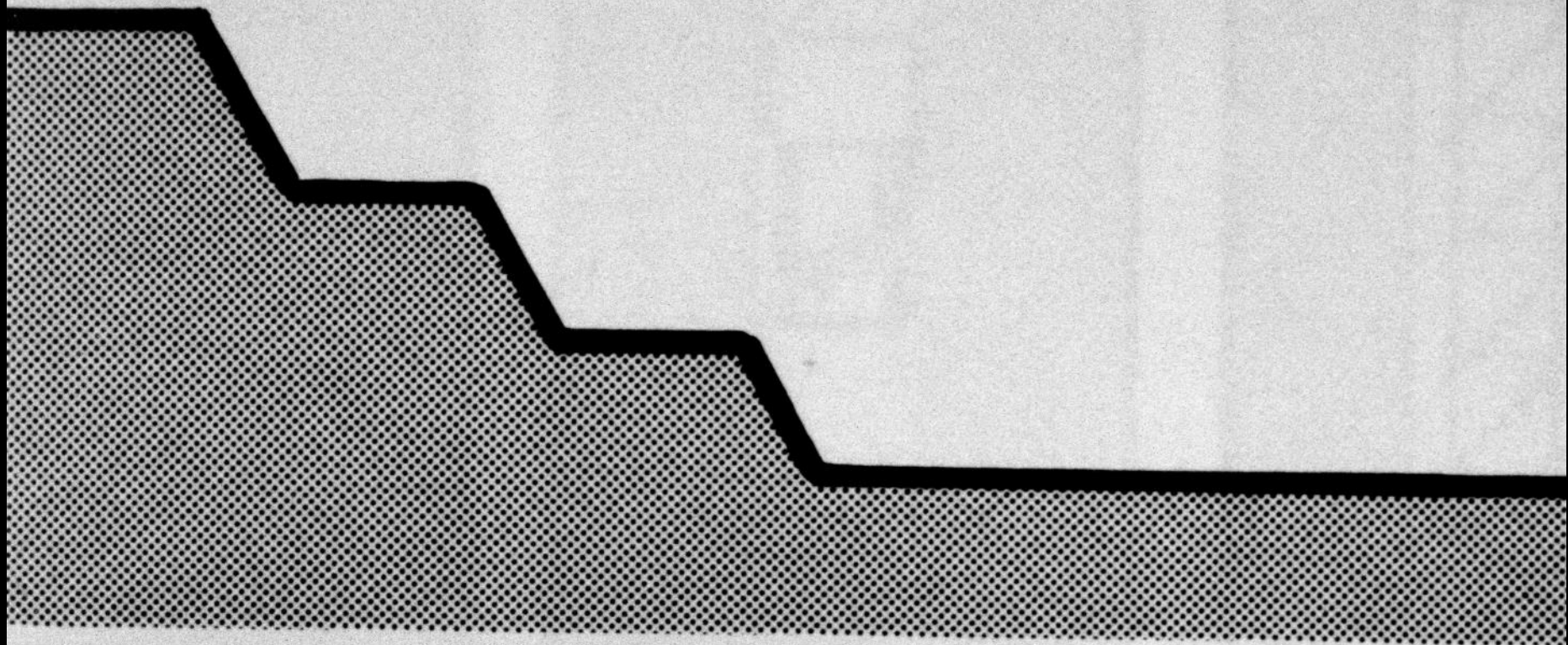

*SECTION THROUGH BENCHED
EXCAVATION*

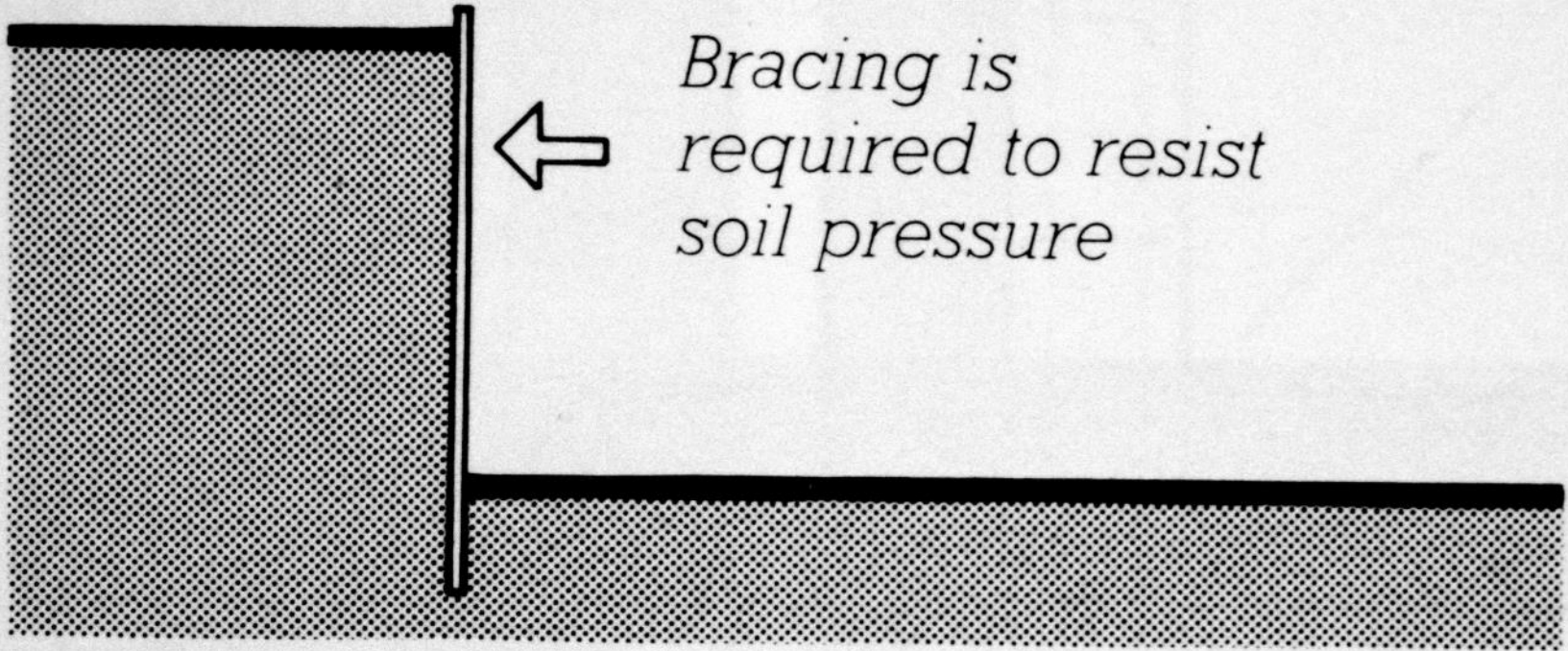

*Bracing is
required to resist
soil pressure*

*SECTION THROUGH SHEETED
EXCAVATION*

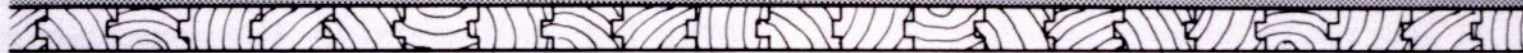

TIMBER SHEET PILING

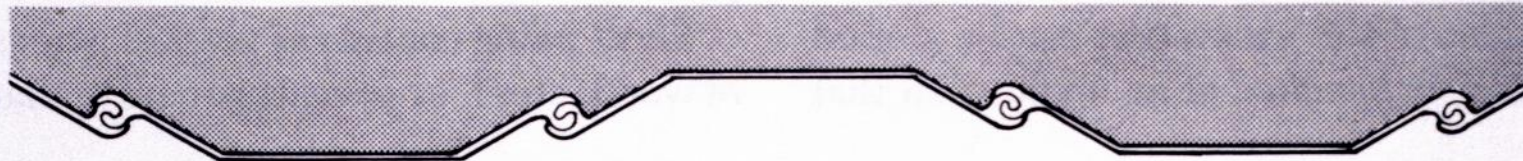

STEEL SHEET PILING

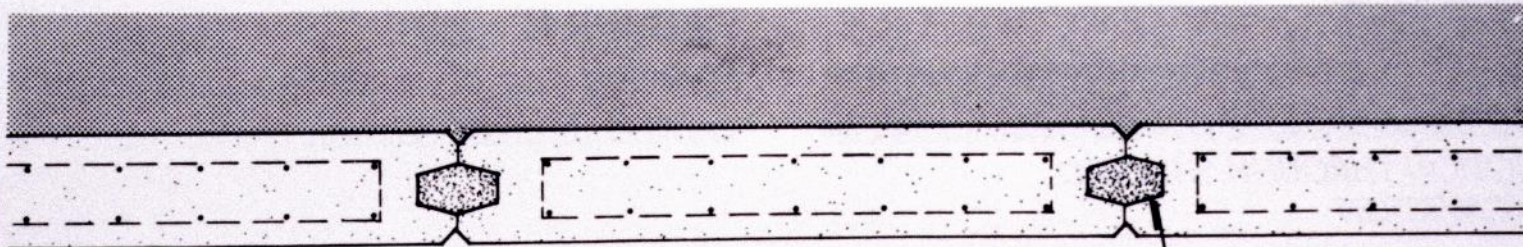

PRECAST CONCRETE SHEET PILING

Grout key



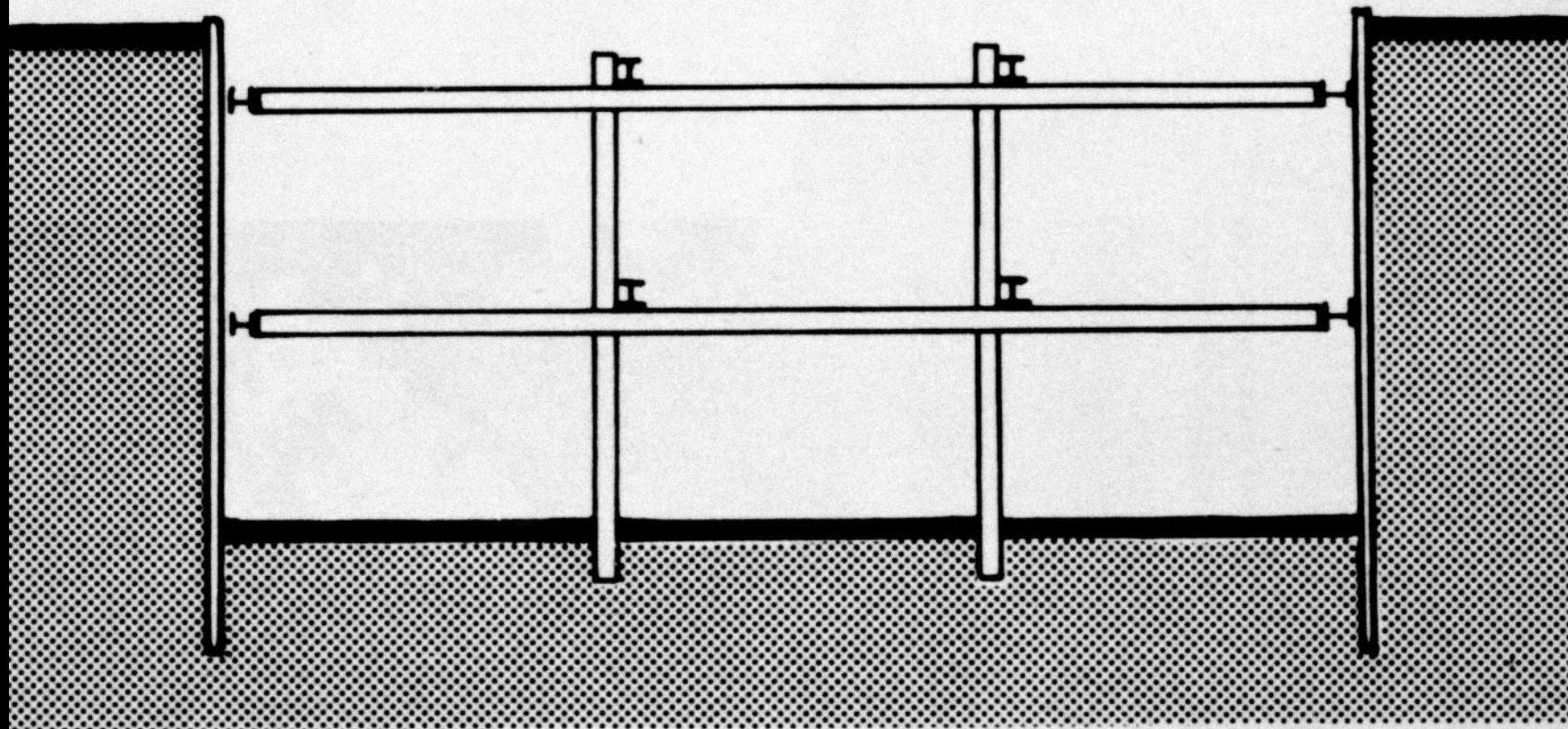

CROSSLOT BRACING

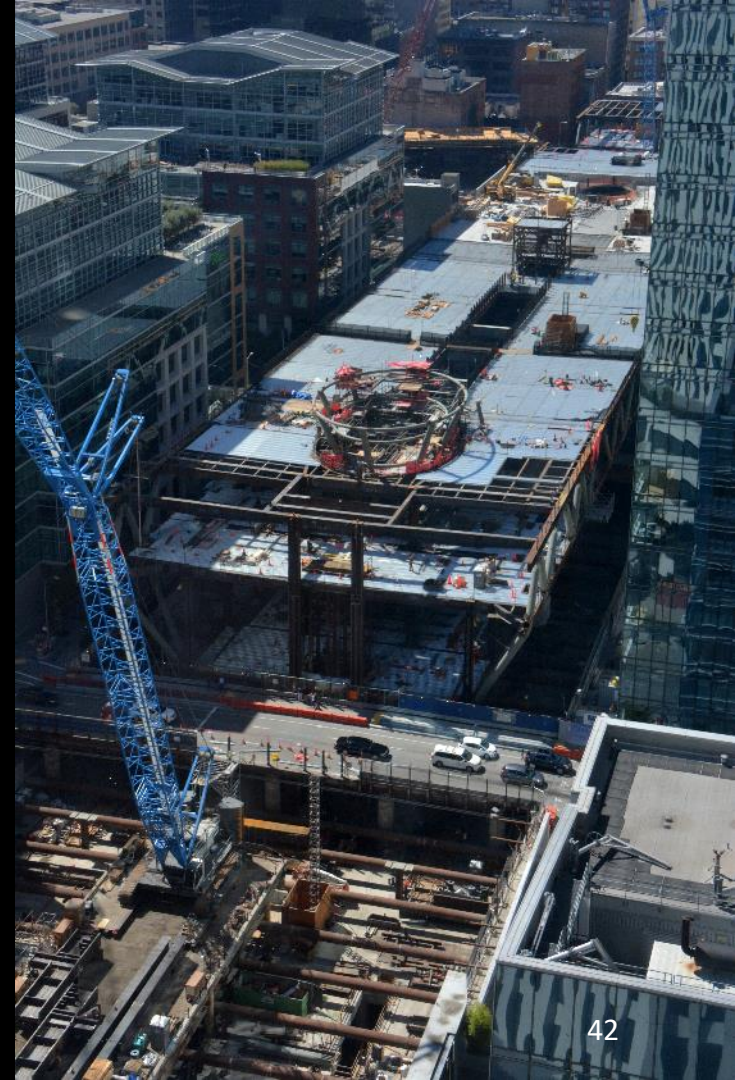





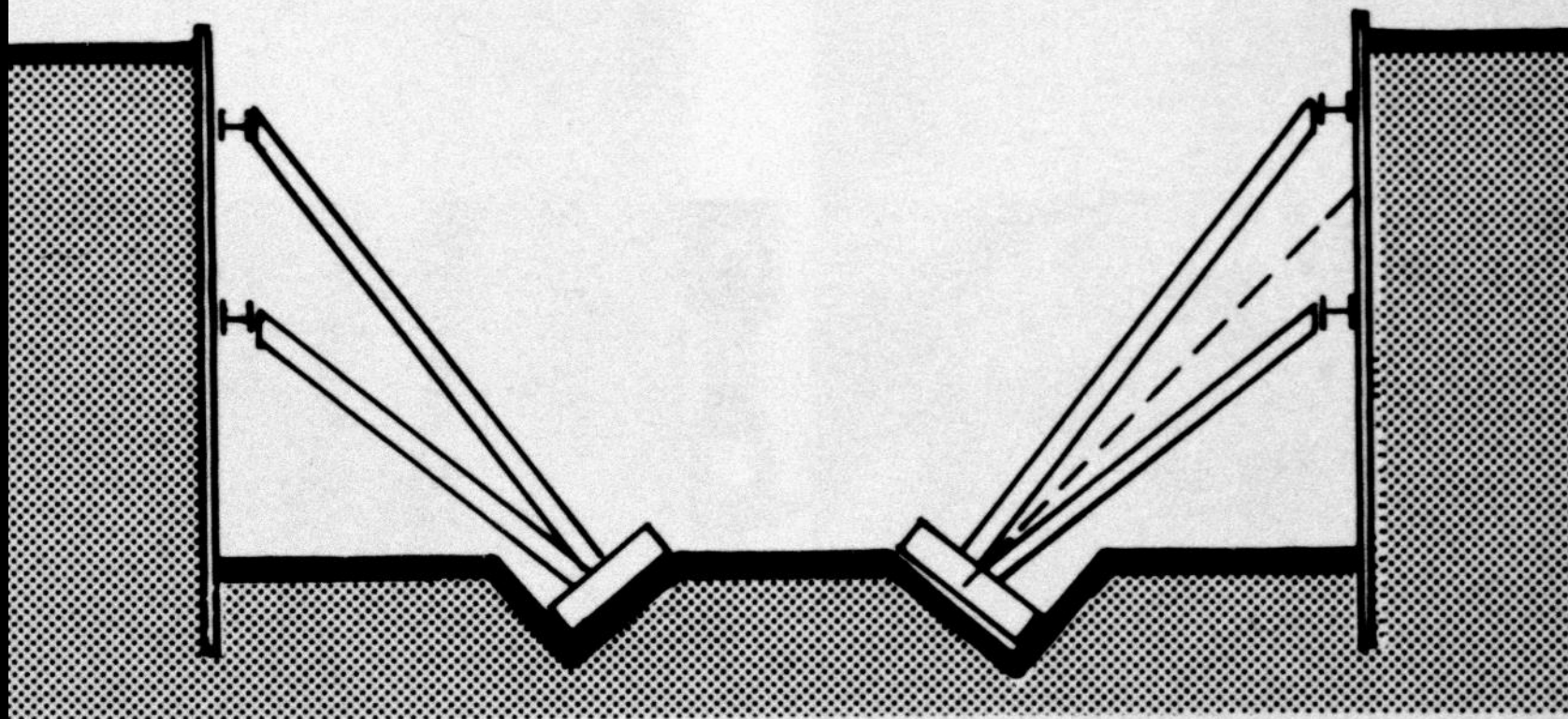

RAKERS











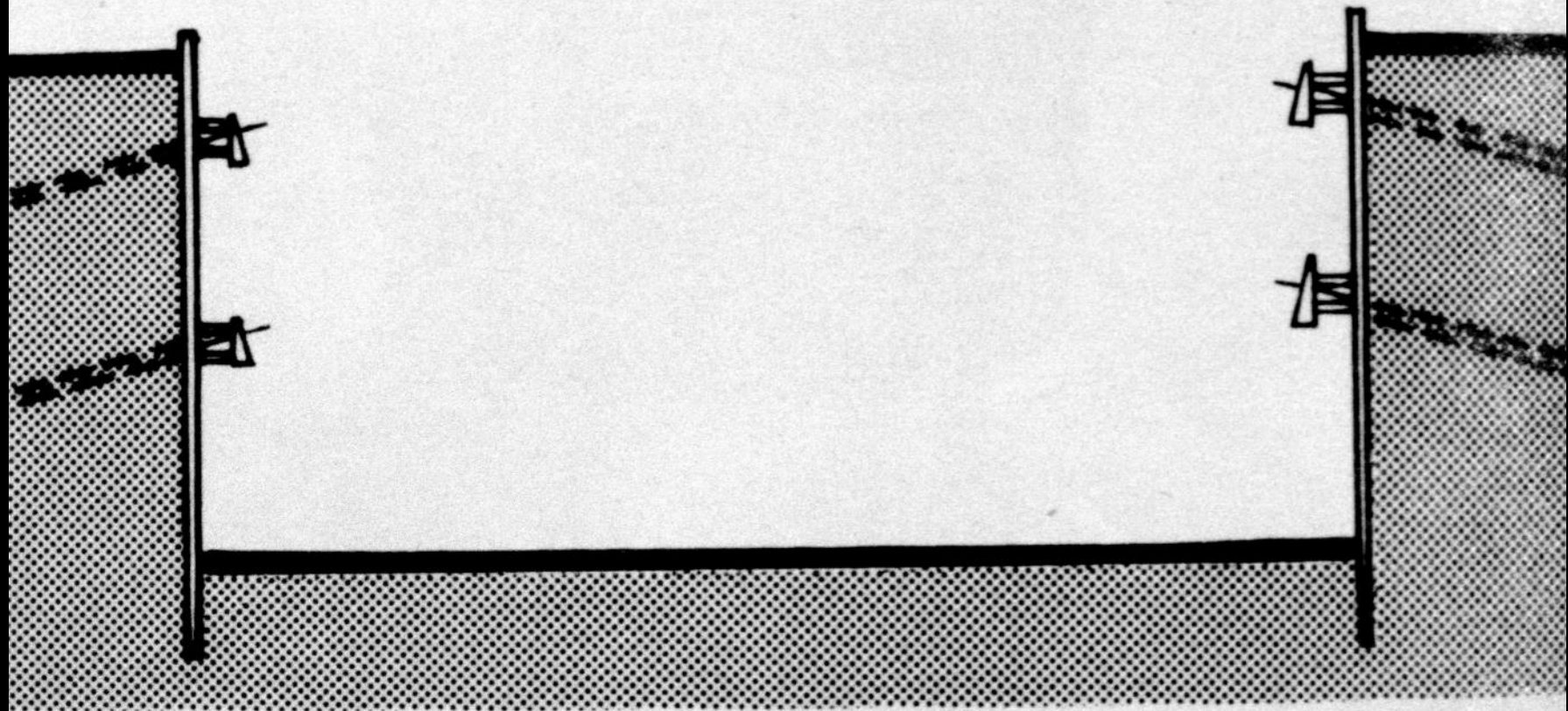

TIEBACKS

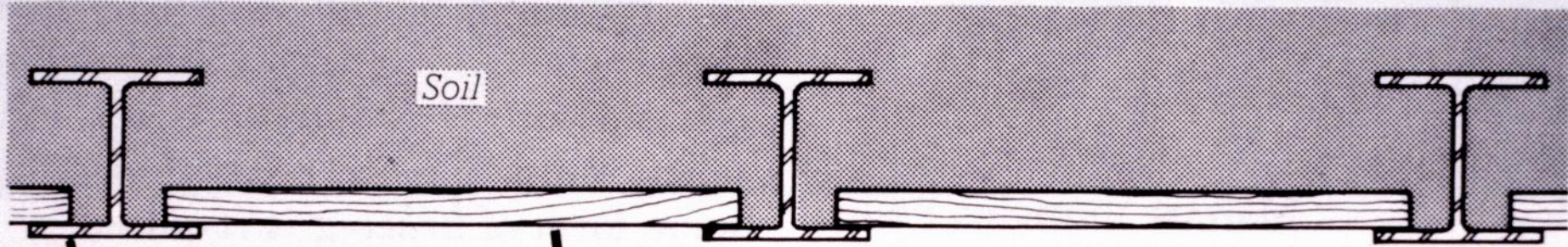

Steel H-pile

*Wooden planks (lagging) are inserted
between the piles to retain the soil as
excavation progresses*

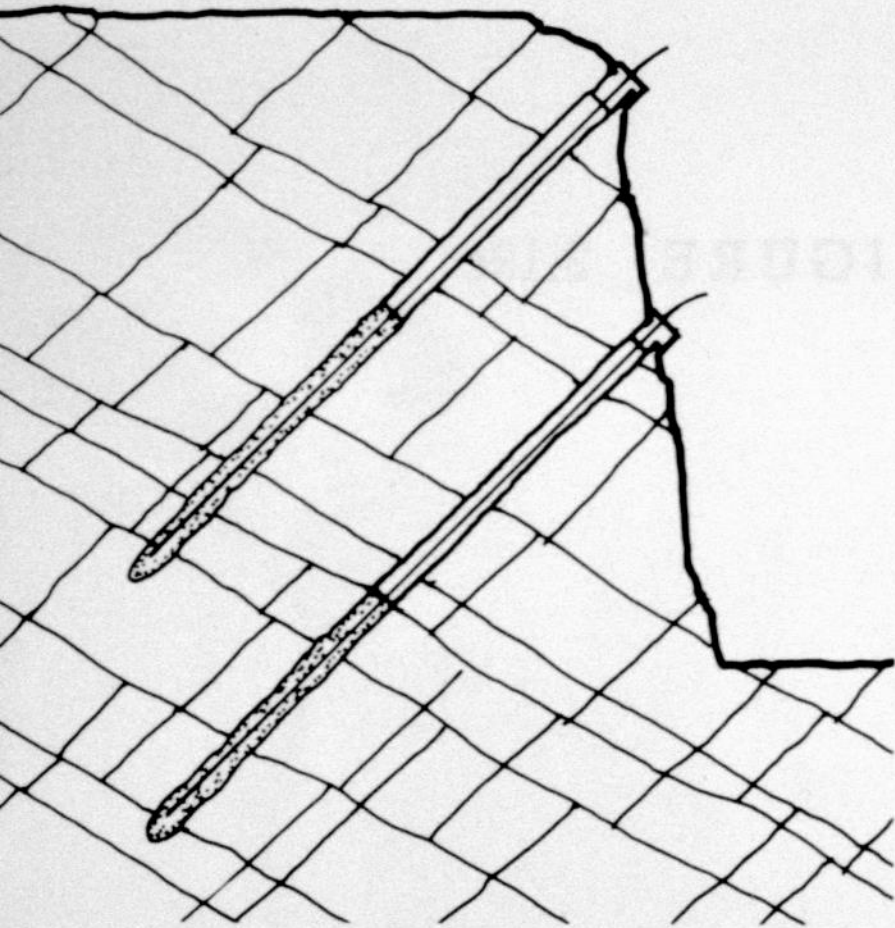
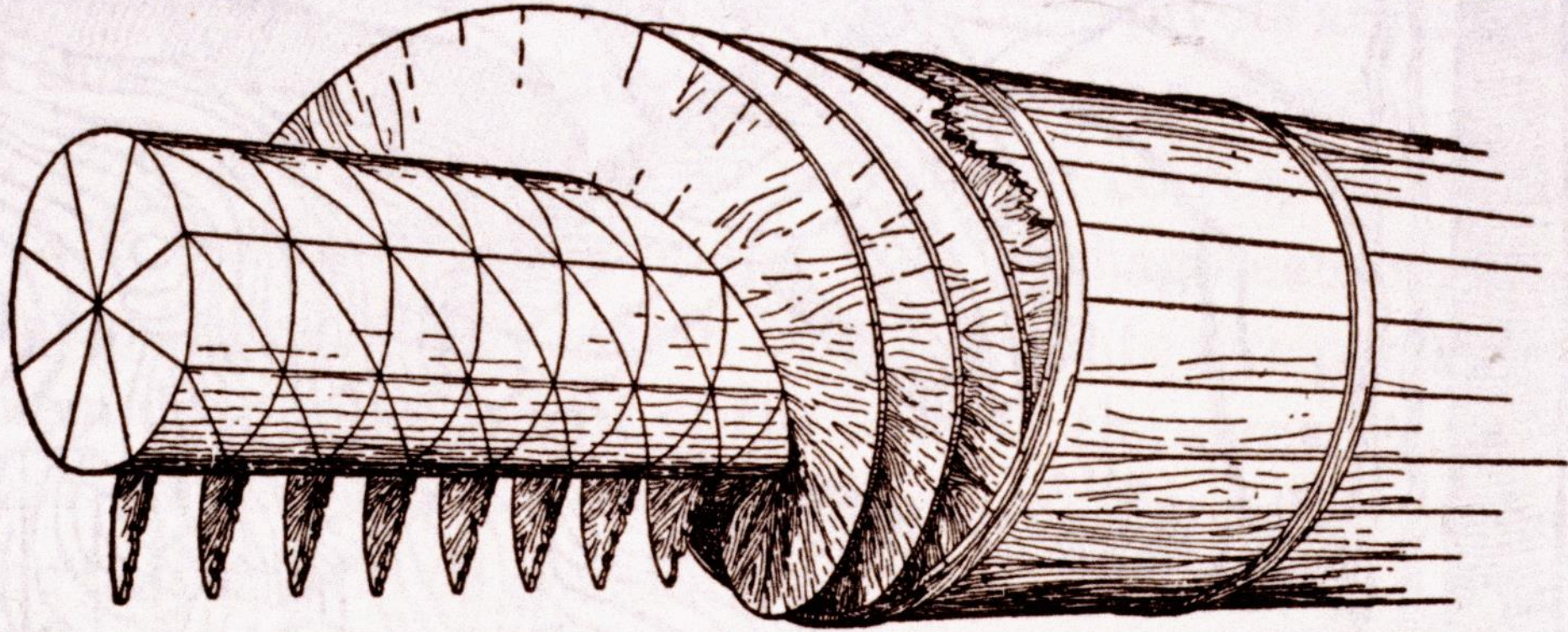

FIGURE 2.20

Rock anchors are similar to tiebacks, but are used to hold jointed rock formations in place around an excavation.



CONSTRUCTION OF THE WATER SCREW

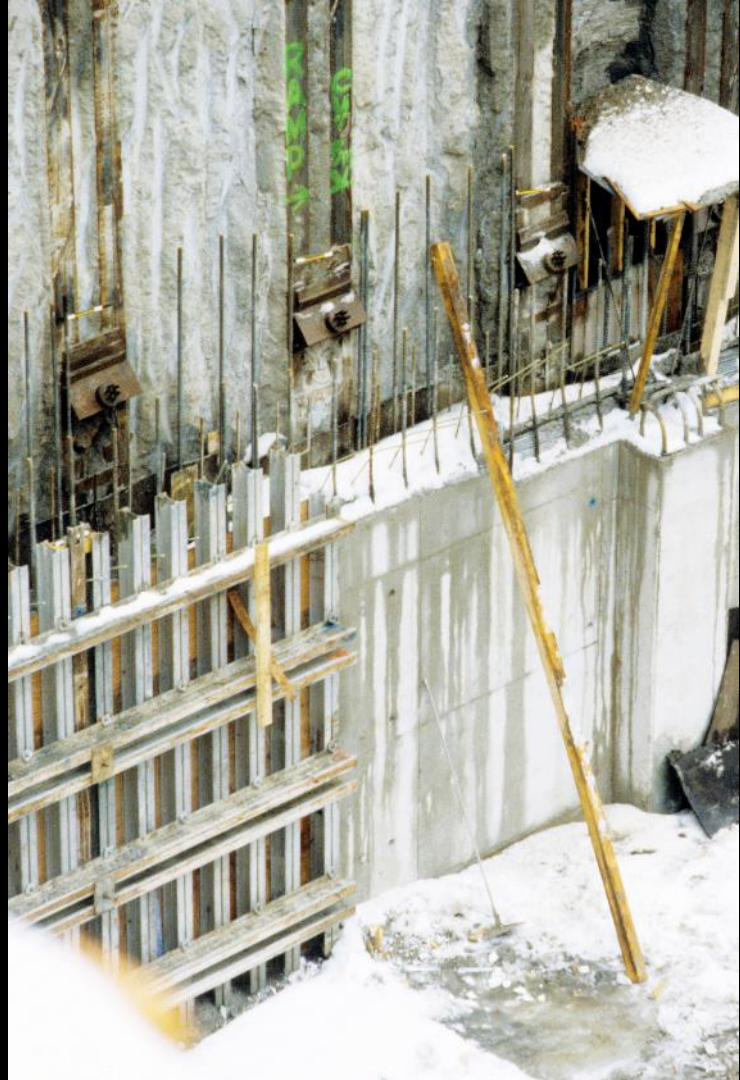















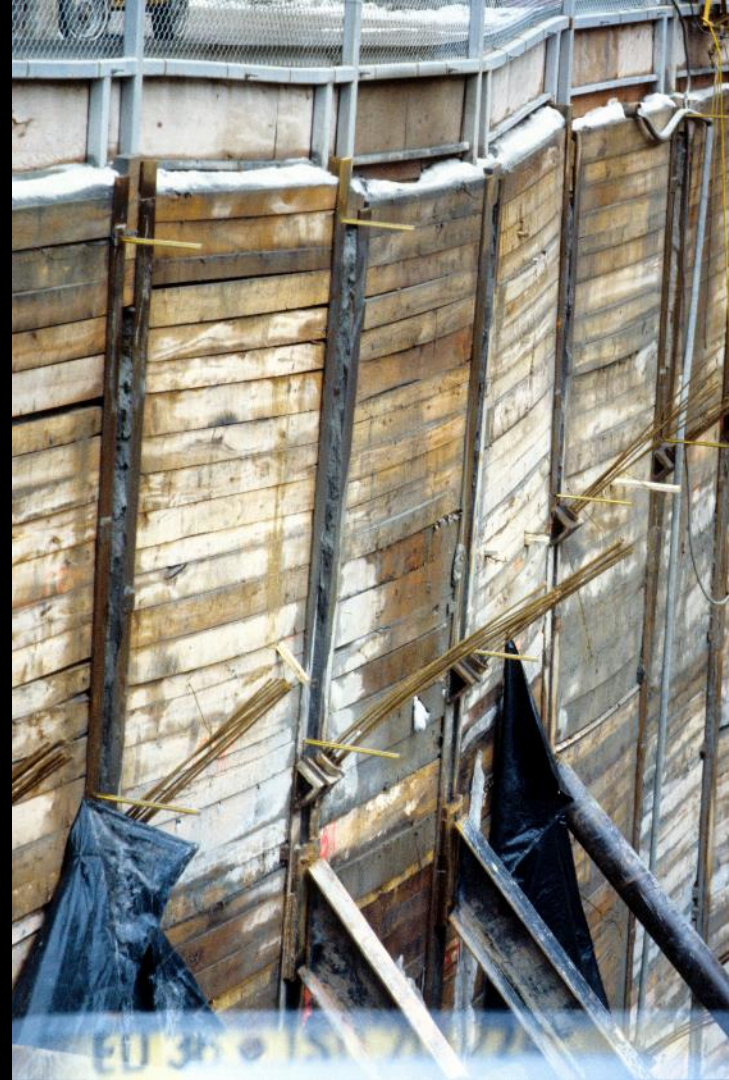

















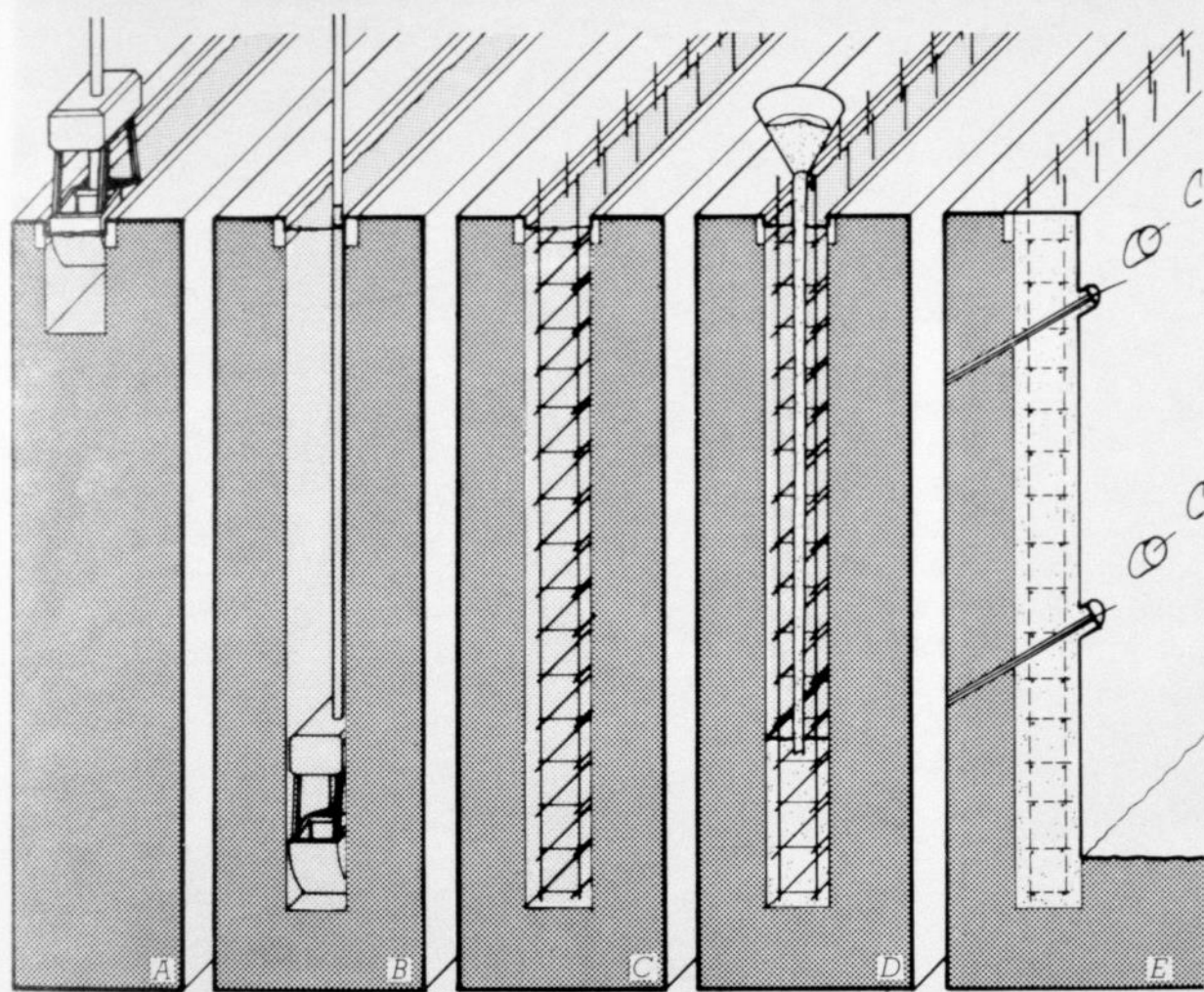

FIGURE 2.14

Steps in constructing a slurry wall. A. The concrete guide walls have been installed, and the clamshell bucket begins excavating the trench through a Bentonite clay slurry. B. The trench is dug to the desired depth, with the slurry serving to prevent collapse of the walls of the trench. C. A welded cage steel reinforcing bars is lowered into the slurry. D. The trench is concreted from the bottom up with the aid of a tremie. The displaced slurry is pumped from the trench, filtered, and stored for reuse. E. The reinforced concrete wall is tied back as excavation progresses.











































Foundations



It was begun by Bonanno Pisano 1173, carried by Giovanni di Simone 1272 and finished by Tommaso di Andrea 1370. It is 55,80 m. high. It has 8 orders of which 6 open galleries with 180 columns and 293 steps. From the top of it Galileo Galilei experimented the gravitation 1598.







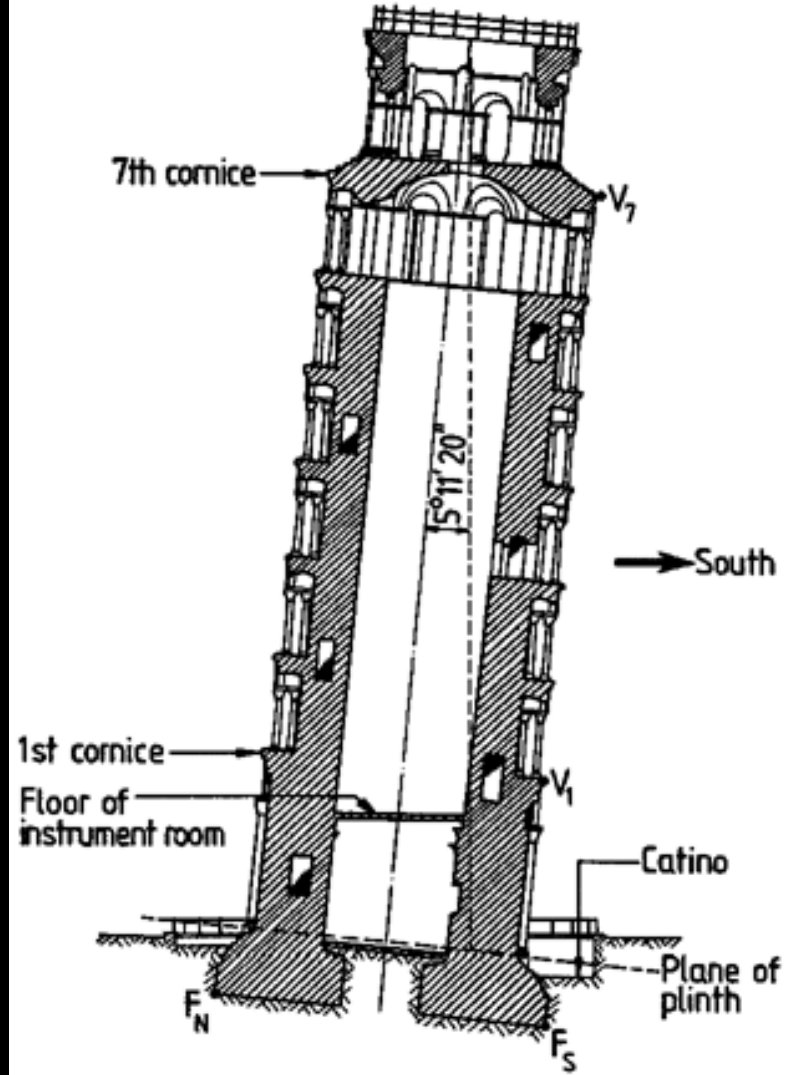
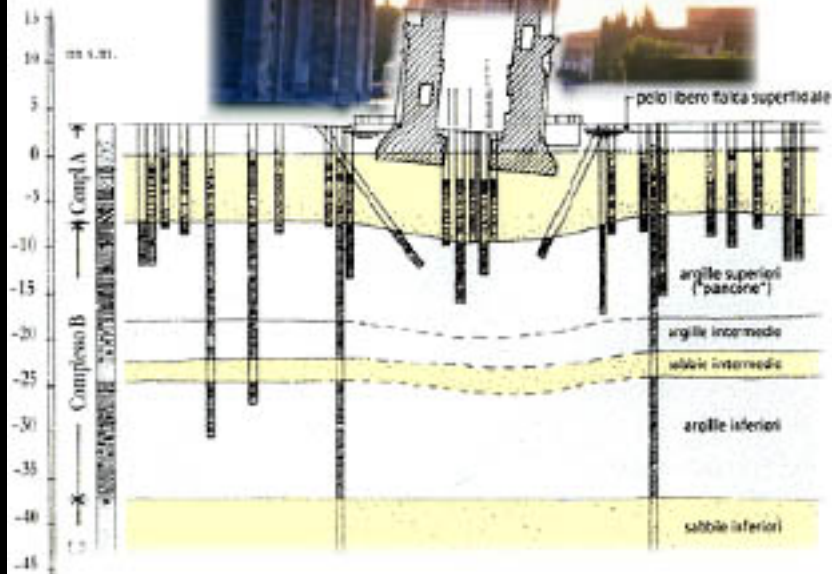

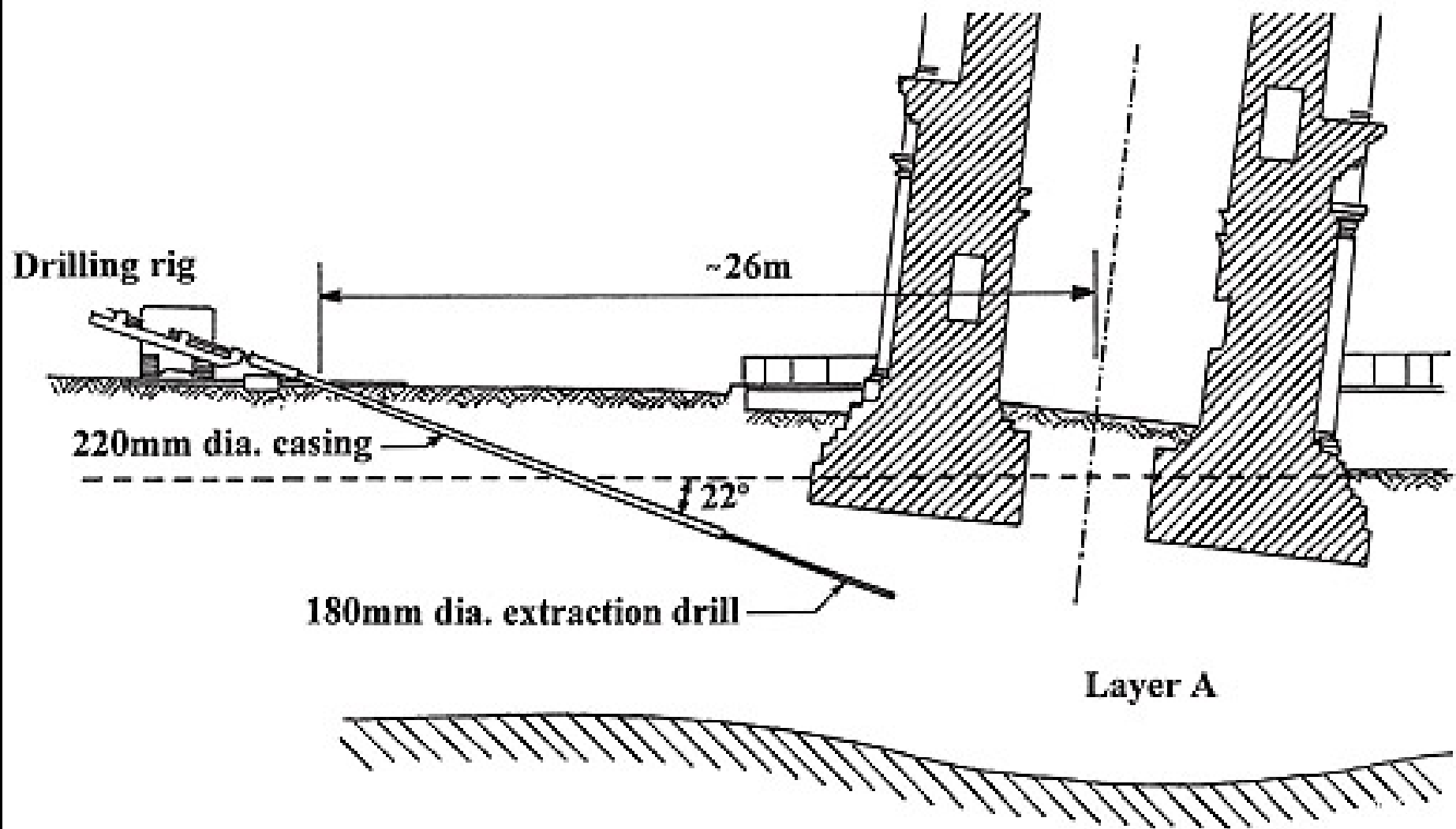





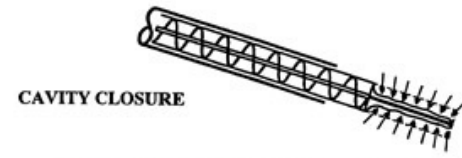
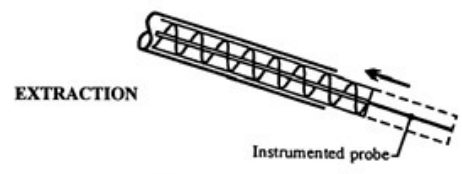
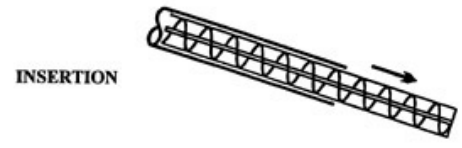
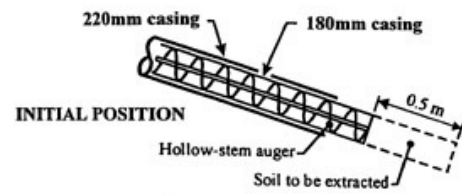

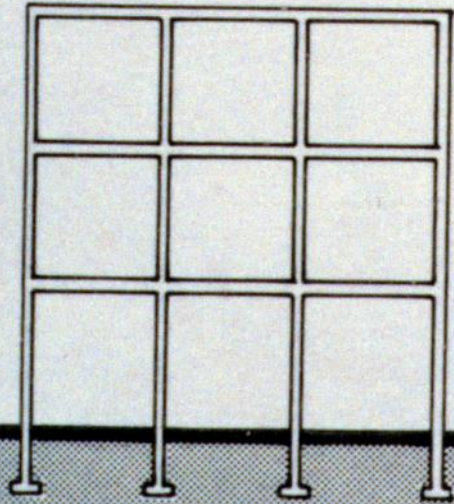

NO SETTLEMENT

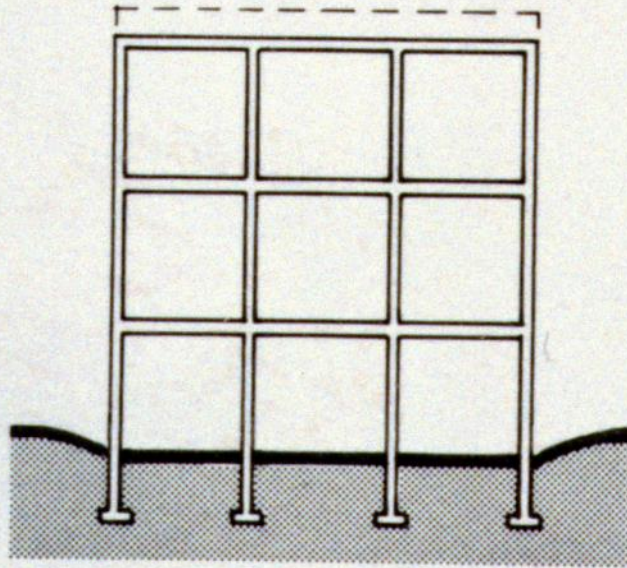

TOTAL SETTLEMENT

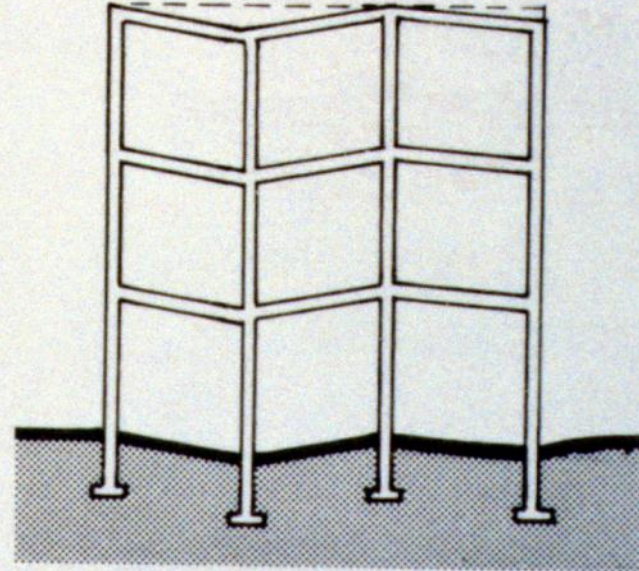

*DIFFERENTIAL
SETTLEMENT*

Shallow Foundations

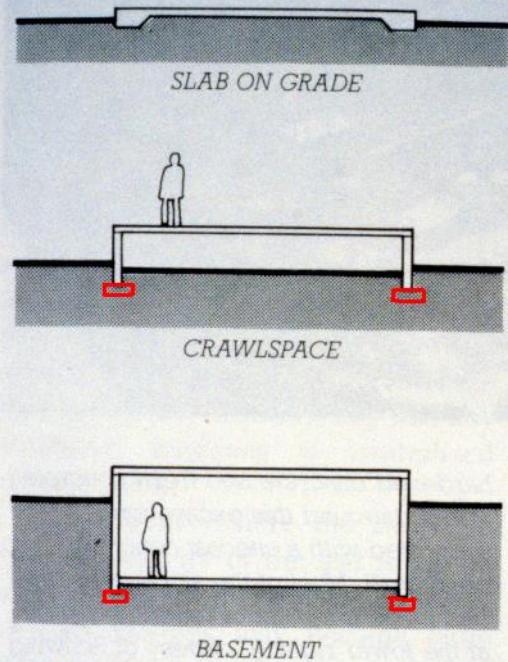
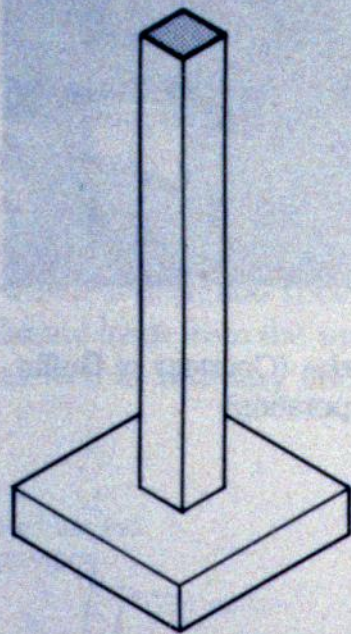
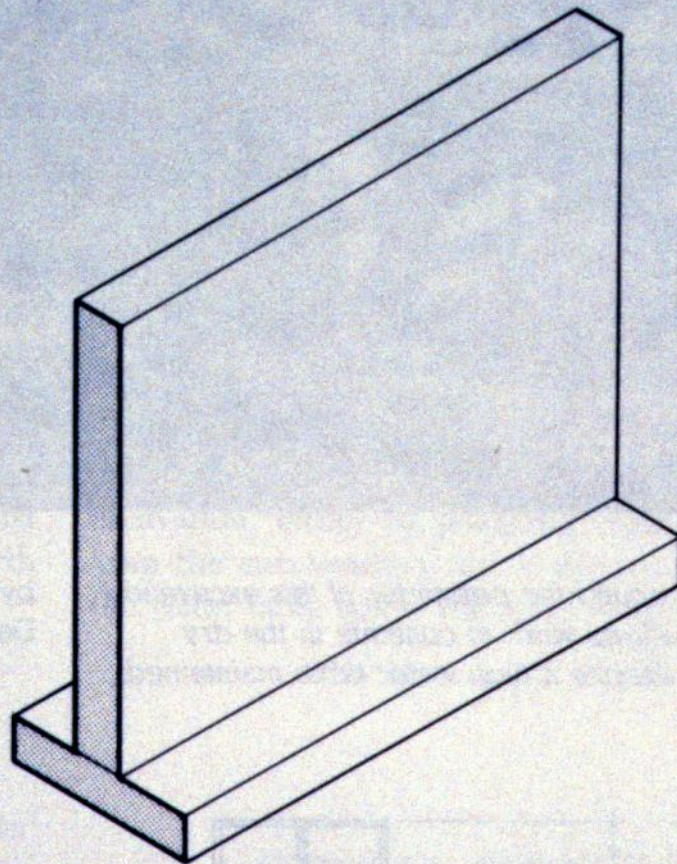

FIGURE 2.26

Three types of substructures using simple wall footings. The slab on grade is most economical under many circumstances, especially where the water table lies near the surface of the ground. A crawlspace is often used under a floor structure of wood or steel, and gives much better access to underfloor piping and wiring than a slab on grade.



COLUMN FOOTING



WALL FOOTING

FIGURE 2.24

A column footing and a wall footing of concrete. The steel reinforcing bars have been omitted for clarity.

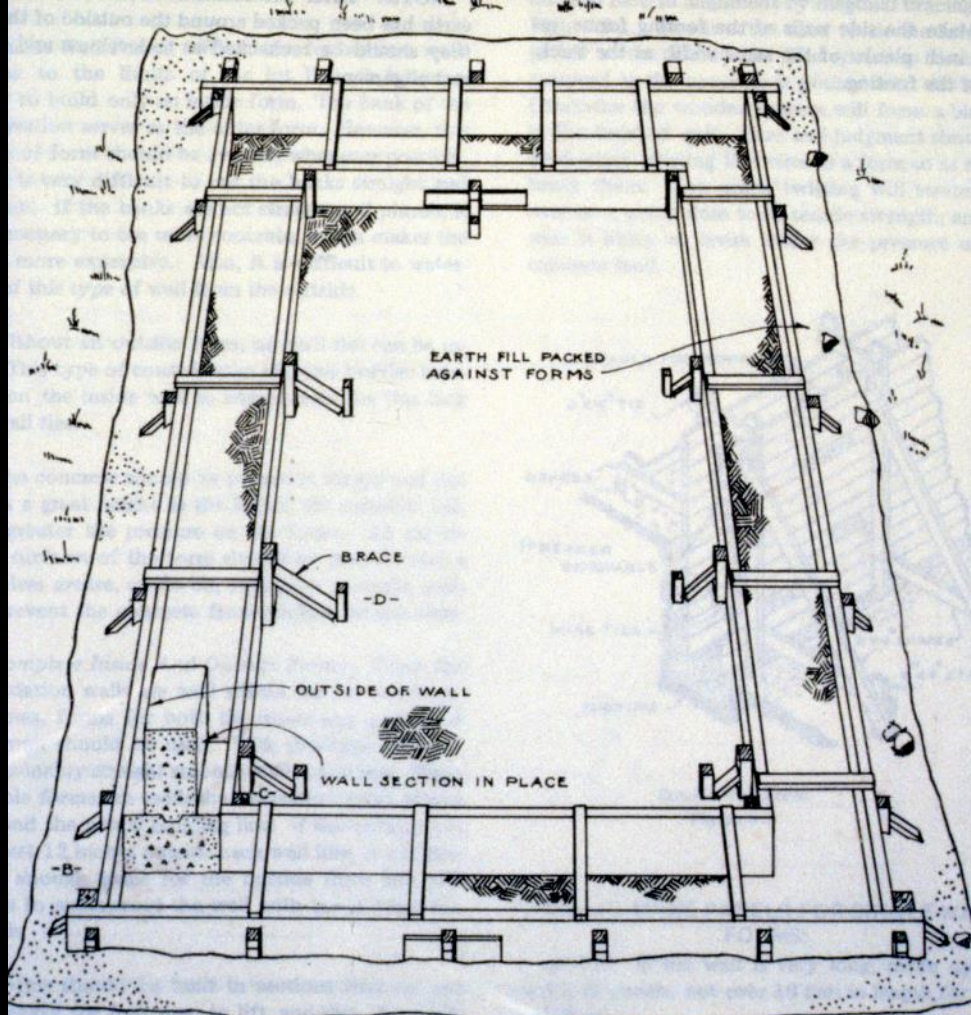

Footing Forms Set in Place

Figure 8-31

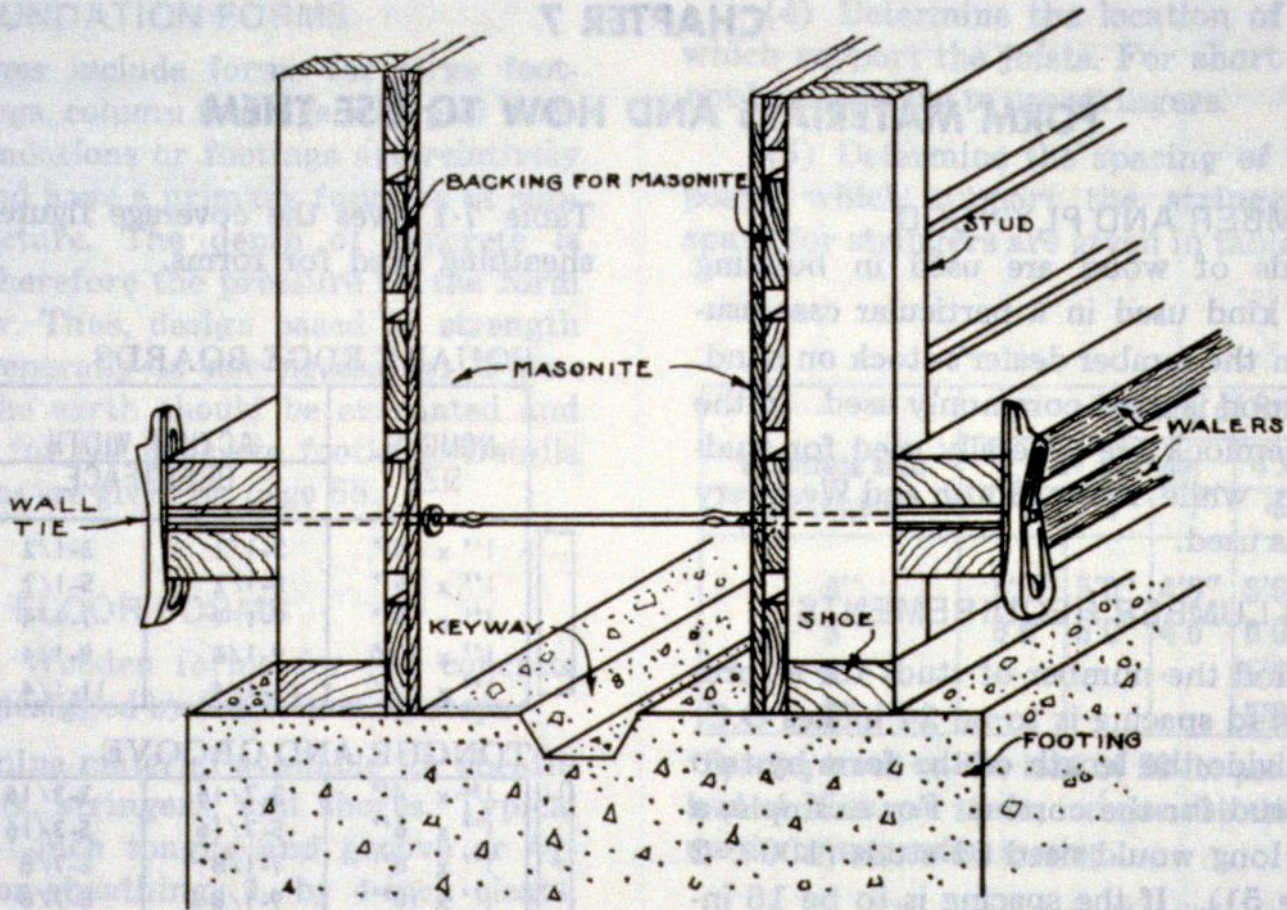

Wooden Form on Footing
Figure 7-1

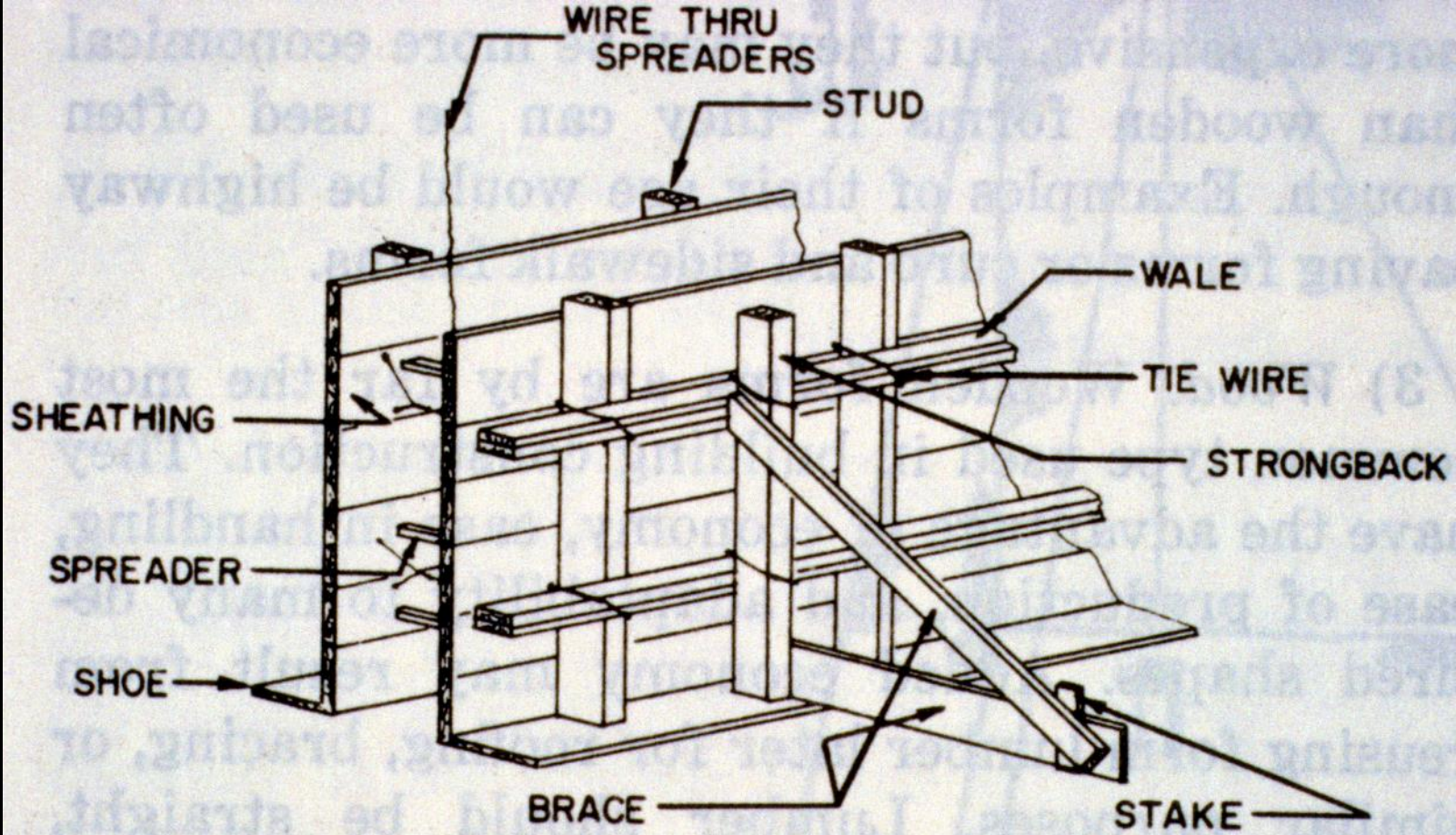

Forms for a concrete wall

Figure 6-1

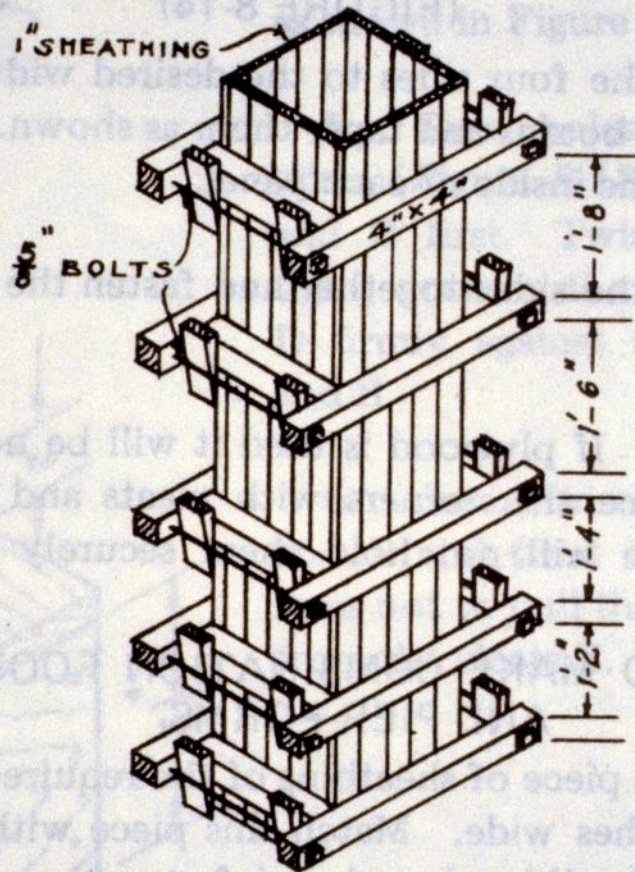

Removable Pier Form

Figure 8-15

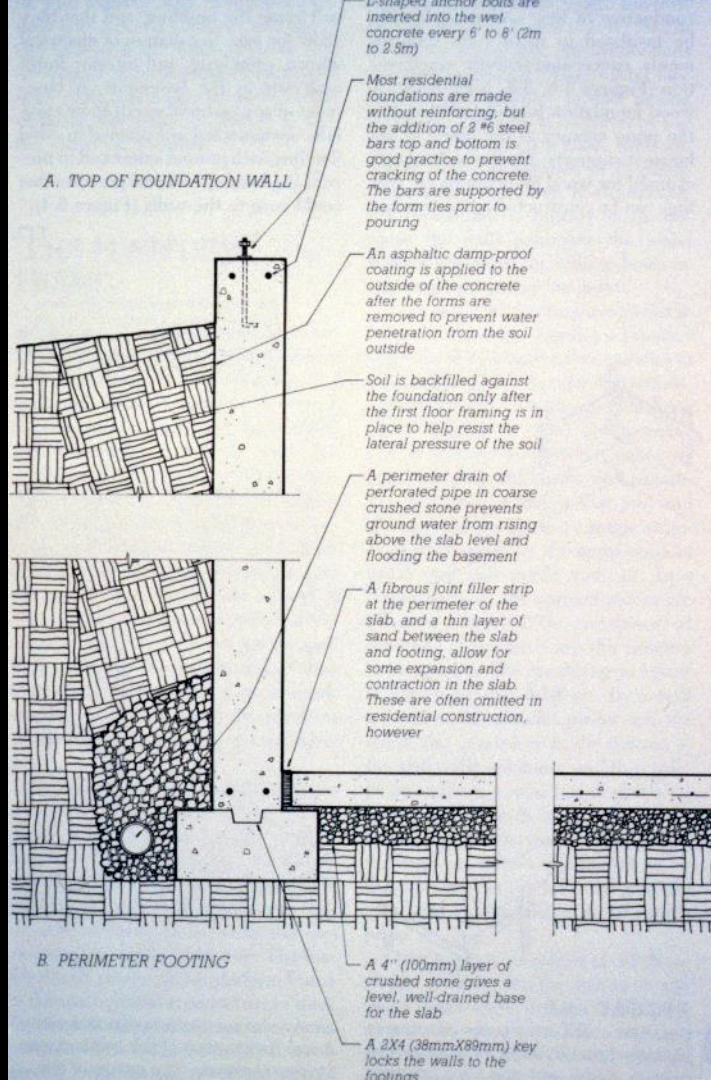

This basic foundation diagram excludes insulation and waterproofing!

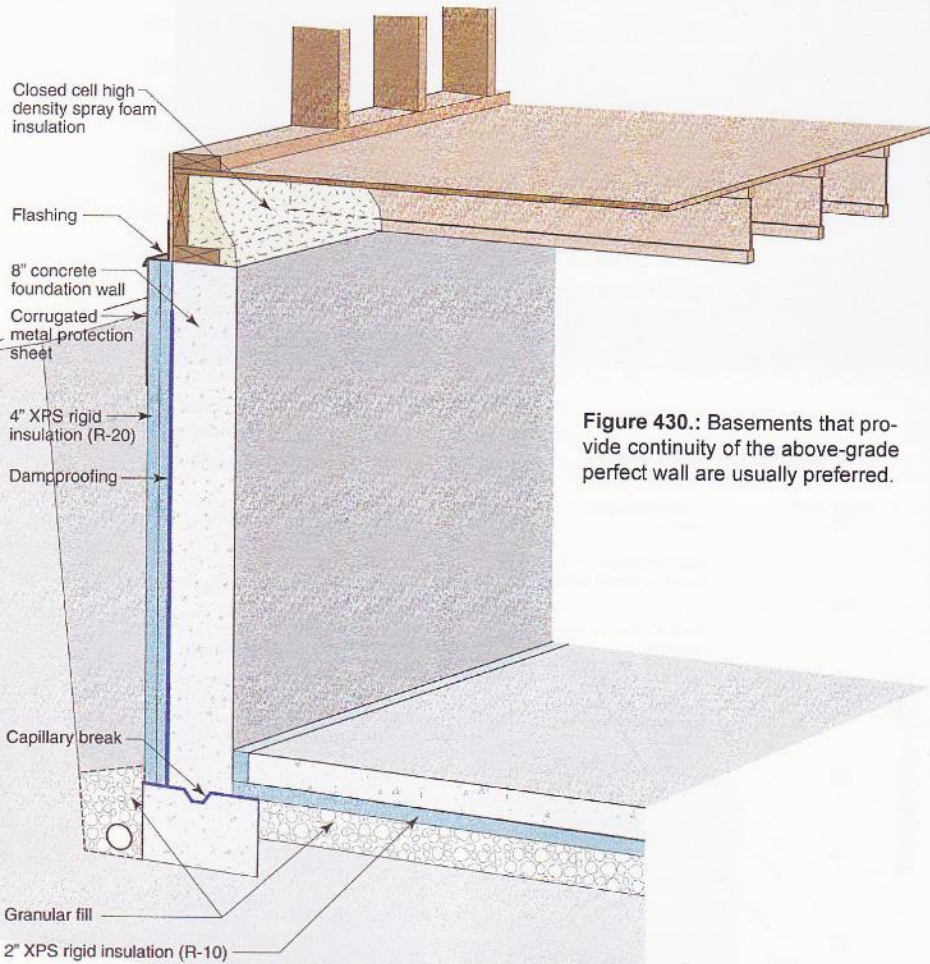

Figure 430.: Basements that provide continuity of the above-grade perfect wall are usually preferred.

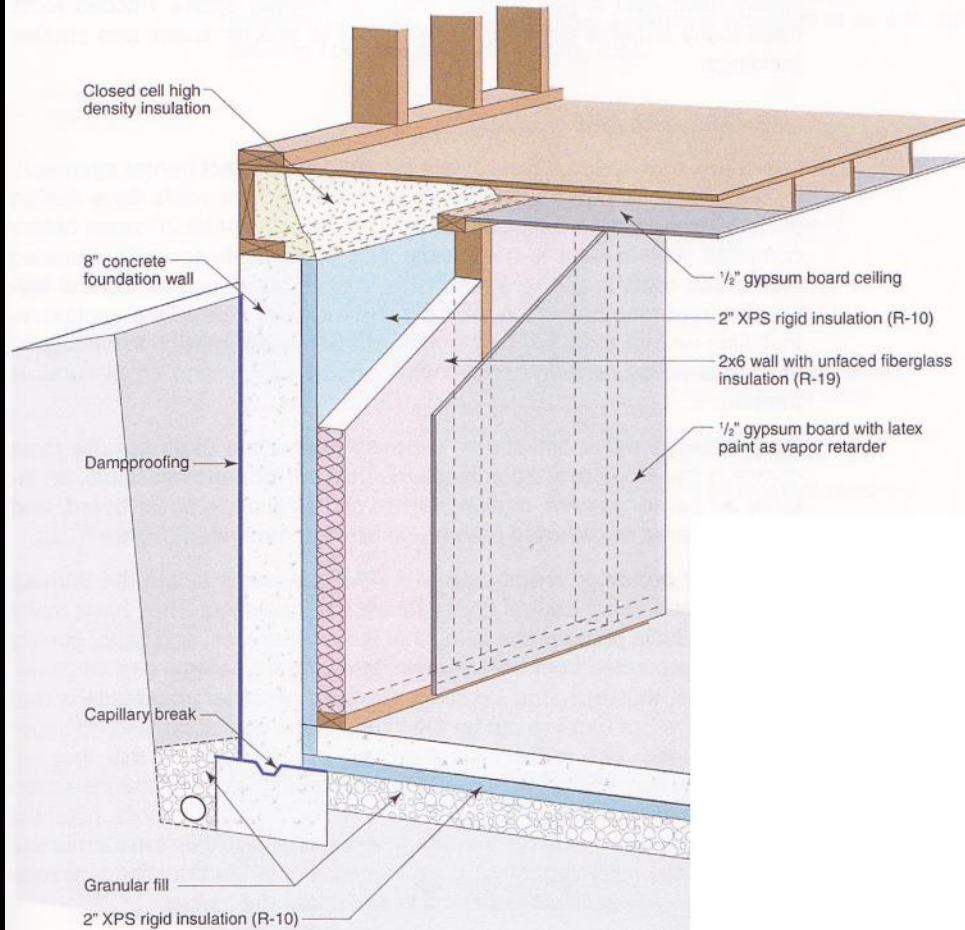
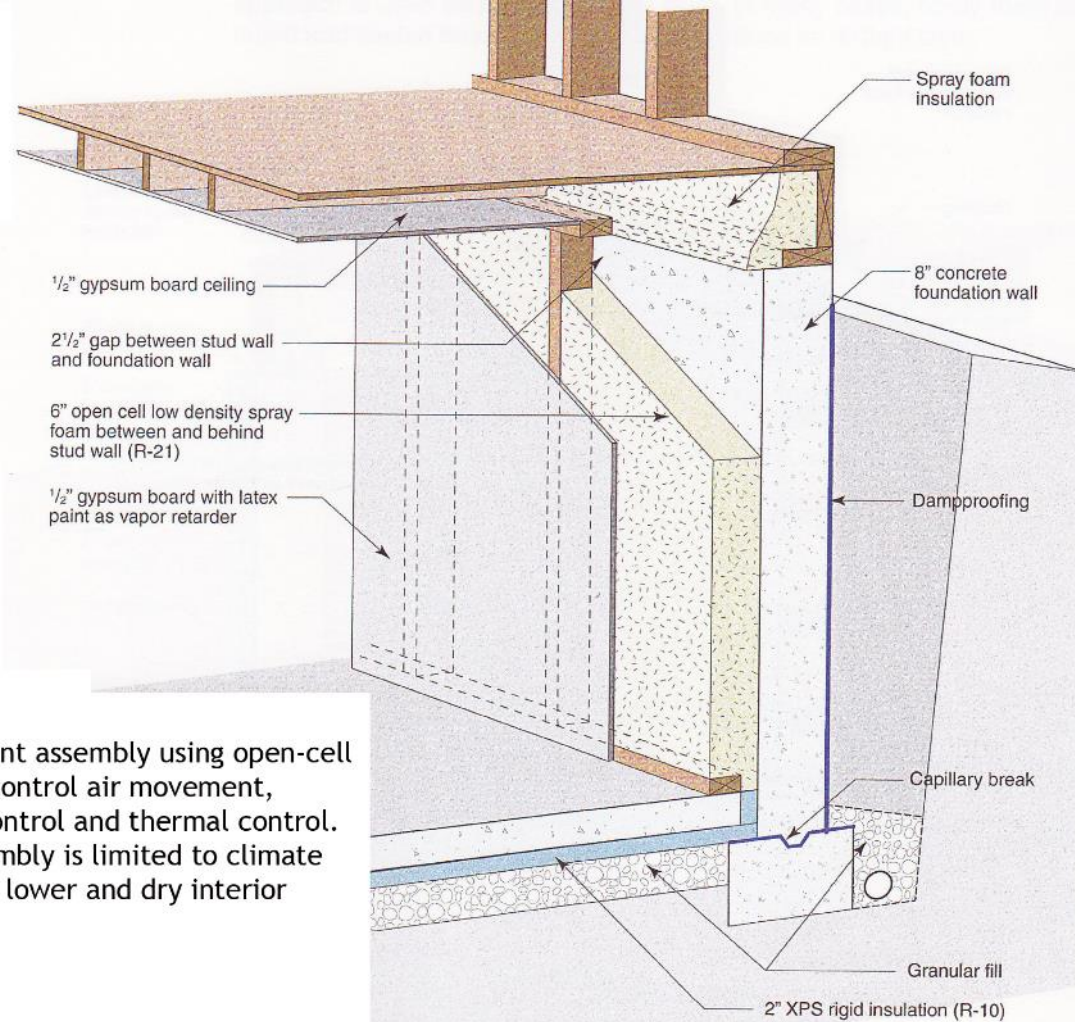

Figure 4.35: A hybrid insulation approach that can be successful in all climate zones (below the permafrost line). No interior low-permeance vapor control layer or finish should be used.



A basement assembly using open-cell foam to control air movement, vapour control and thermal control. This assembly is limited to climate zone 6 or lower and dry interior spaces.

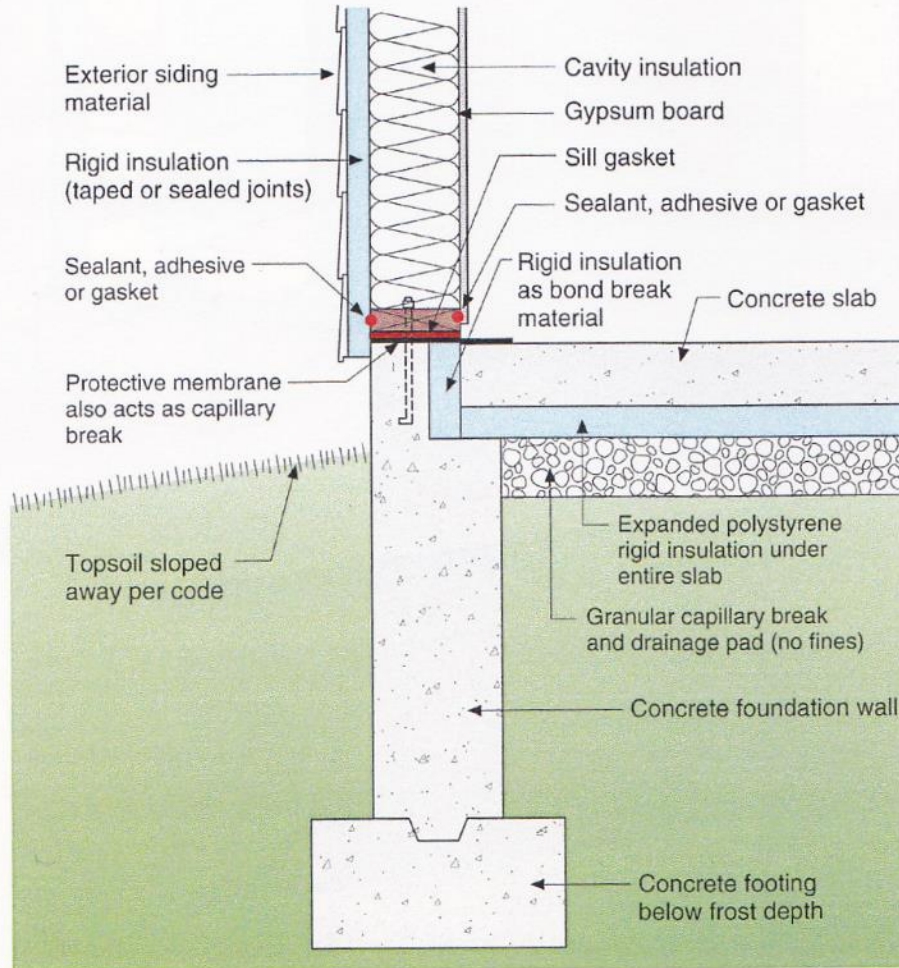
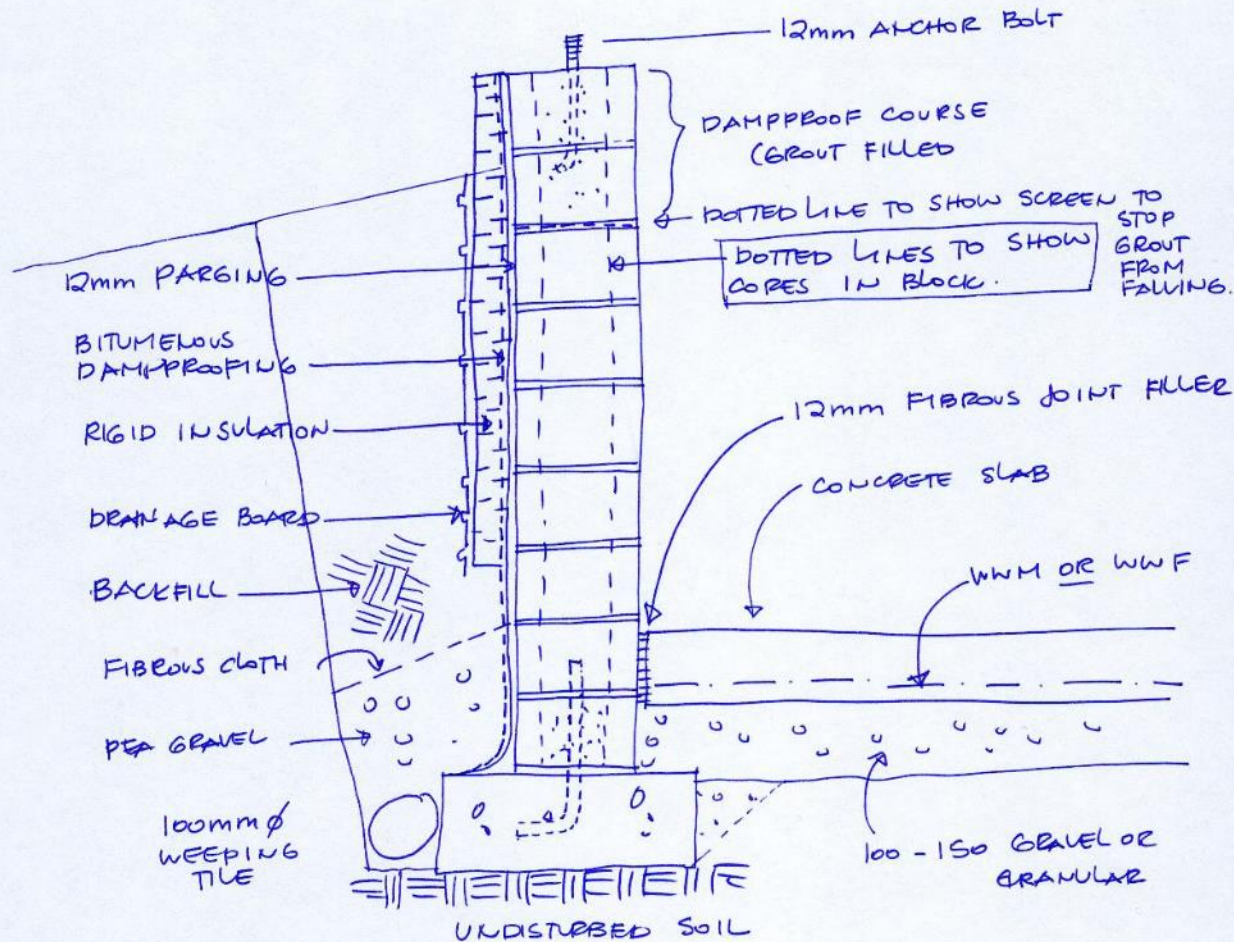

Figure 4.29: An insulated slab with a frost wall supporting a framed wall.











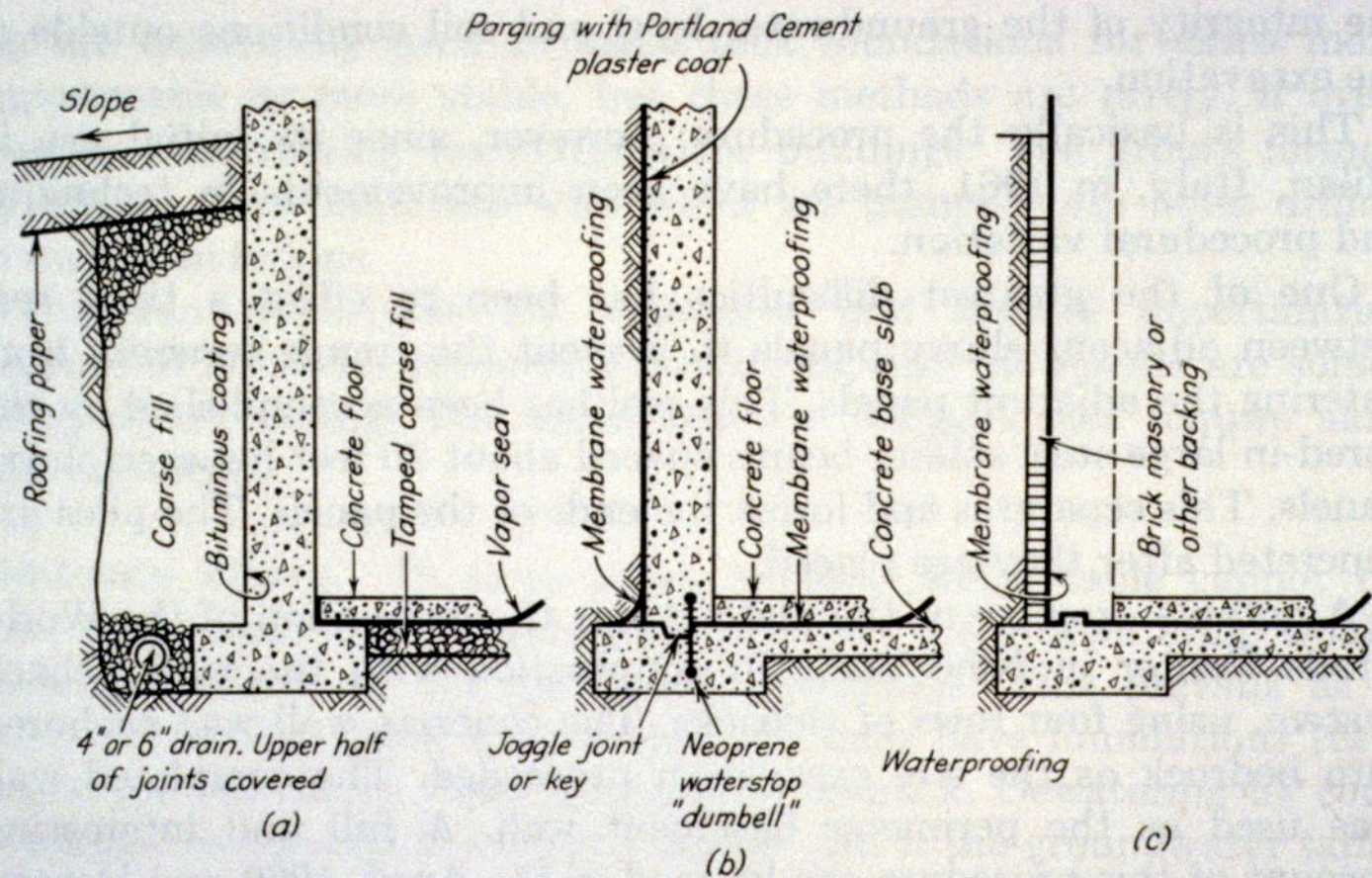

FIGURE 2.63 Dampproofing and waterproofing basements. (a) Damp-proofing. (b) Outside of wall accessible. (c) Outside of wall inaccessible.

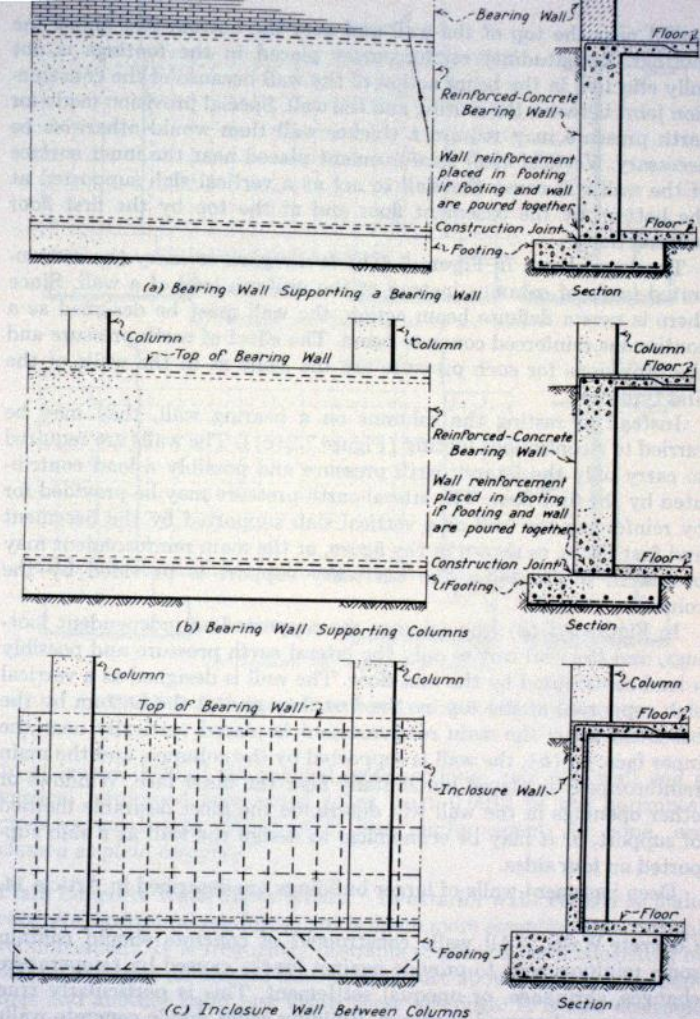

FIGURE 7.2 Reinforced concrete foundation walls.

As soon as the grade difference between the outside and the basement floor exceeds around 2.0m, you need to reinforce the concrete wall.

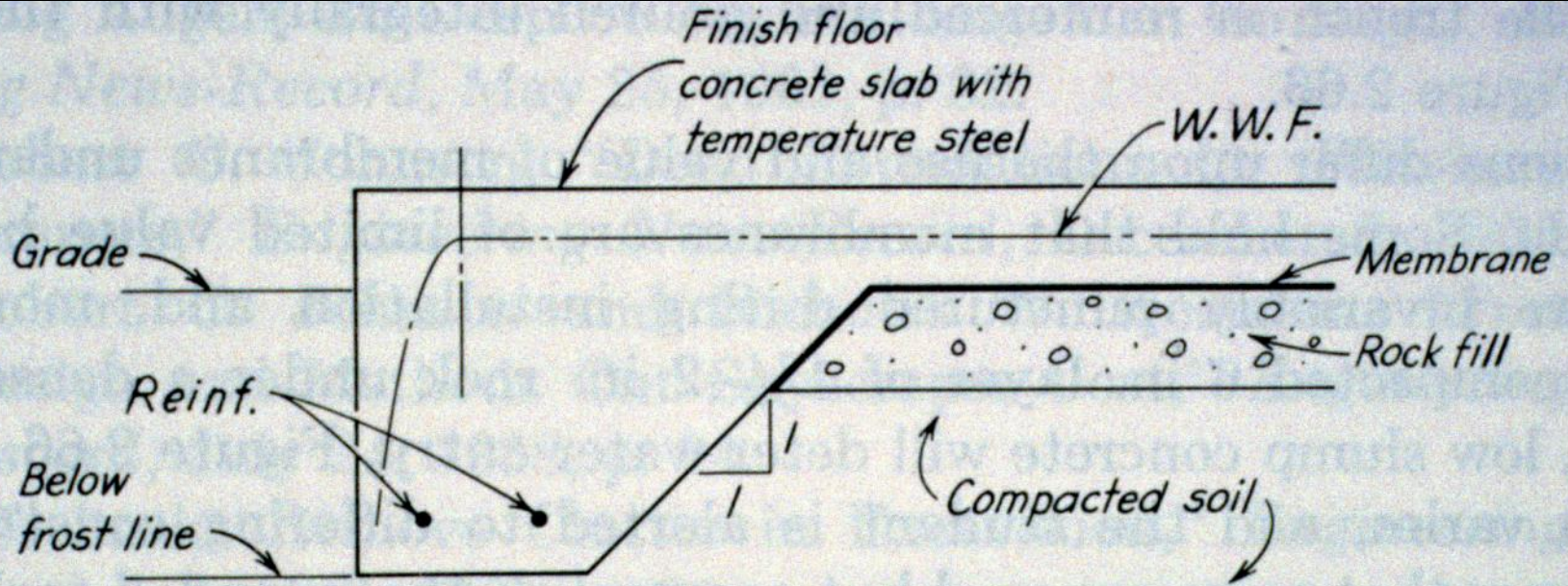

FIGURE 2.65 Thickened slabs.

















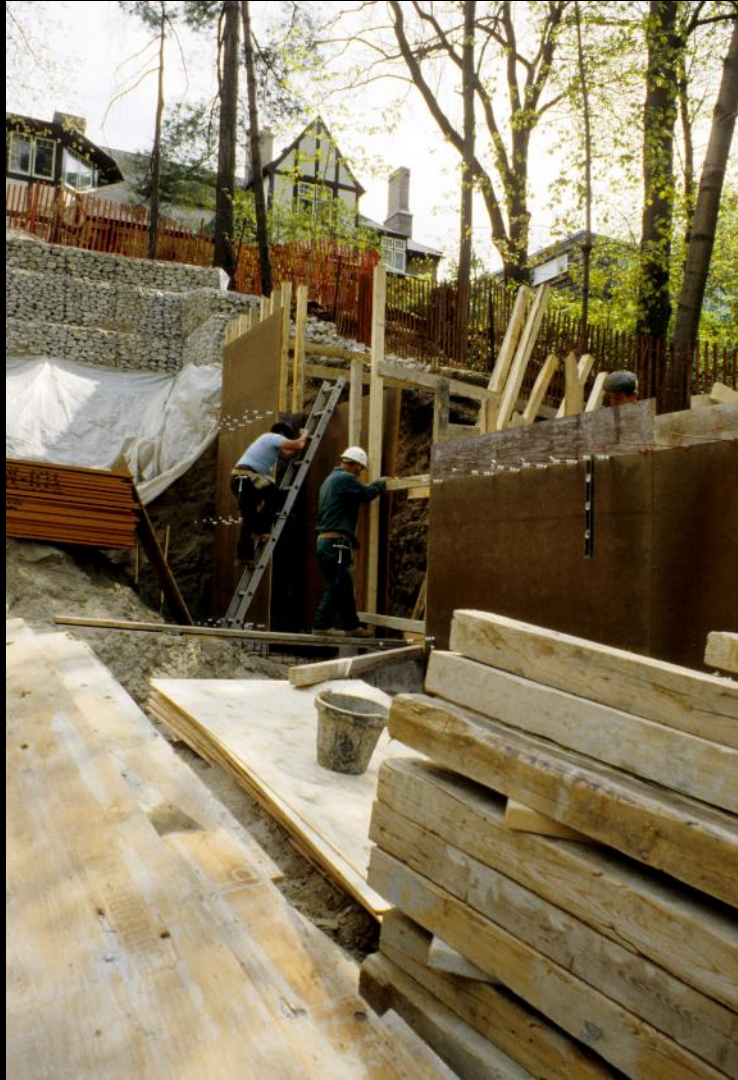



























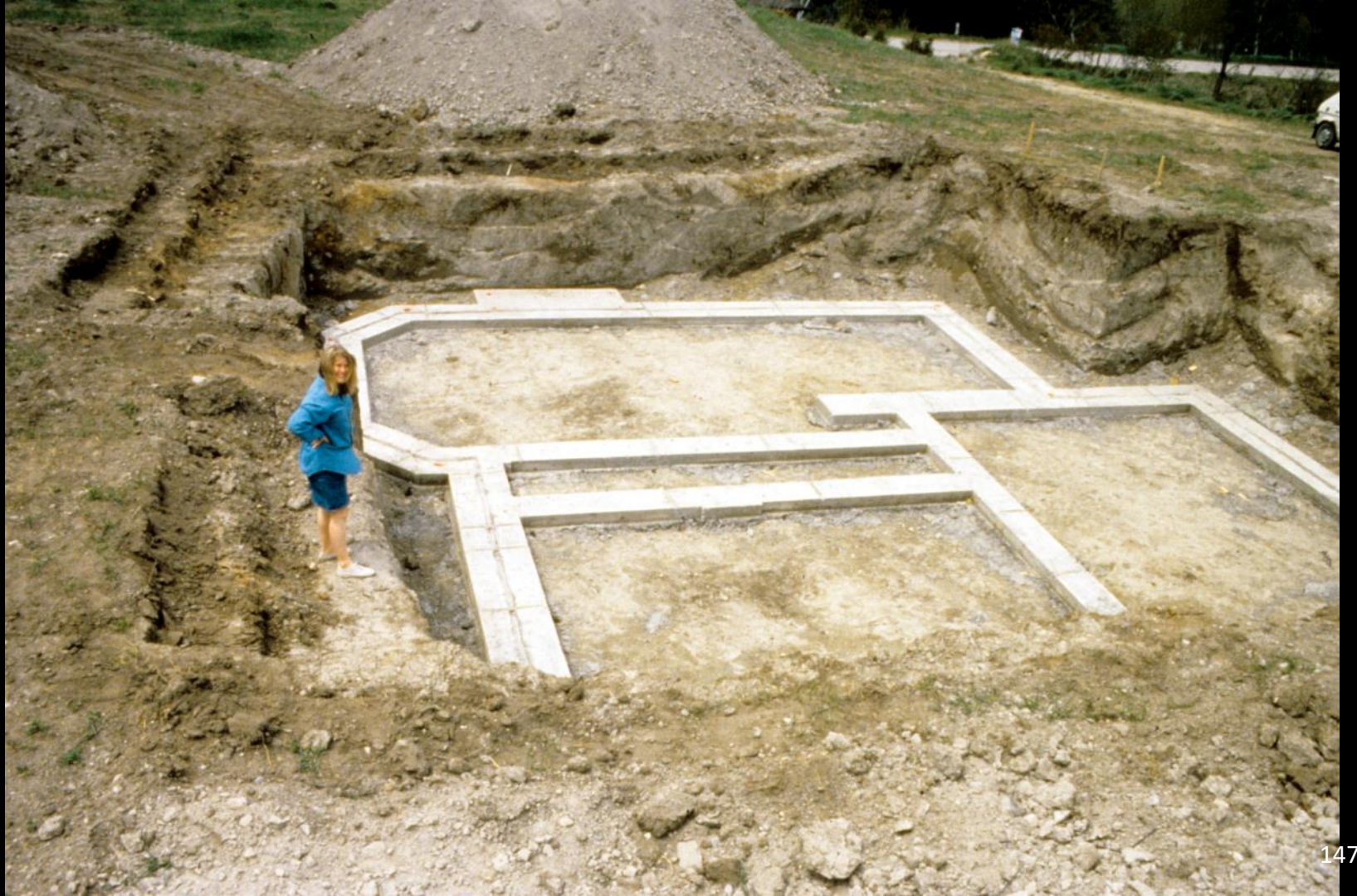













Insulated concrete forms (ICF)

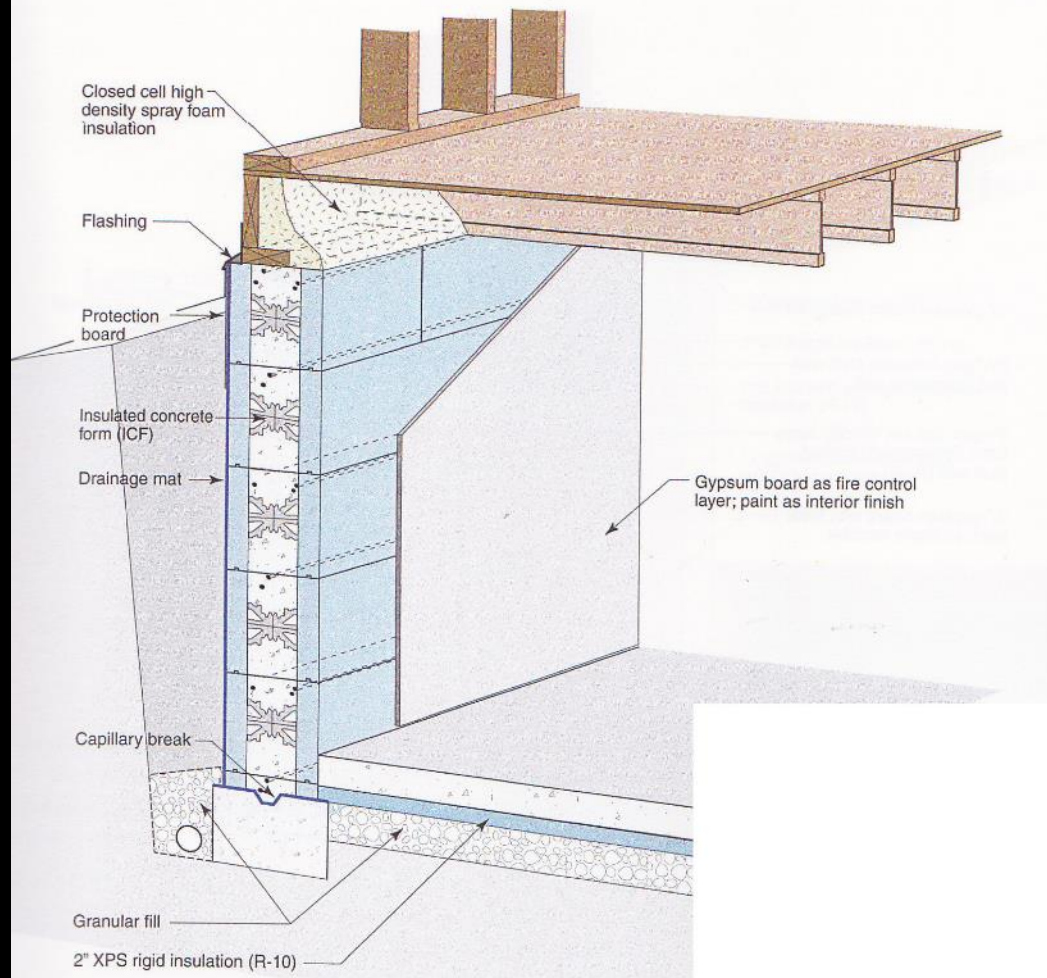

Figure 4.31: ICF Basements systems can be ideal high-performance basement enclosures.





































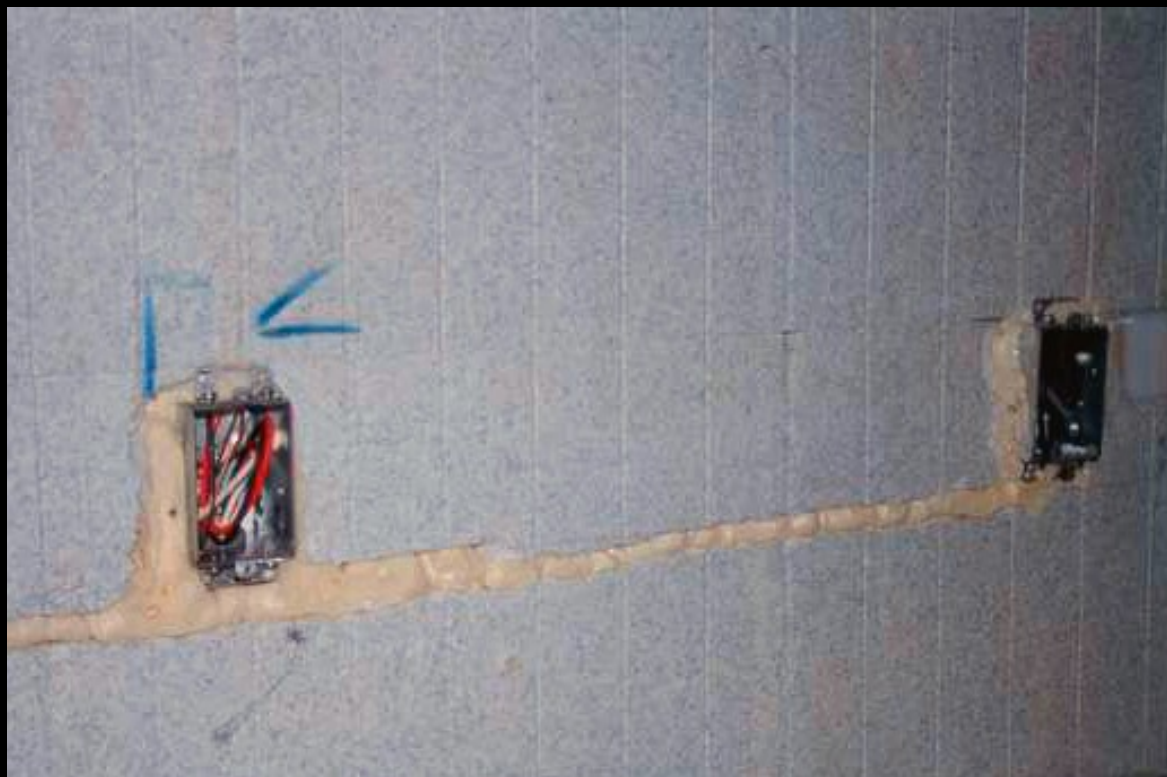























Deep Foundations for Larger Buildings

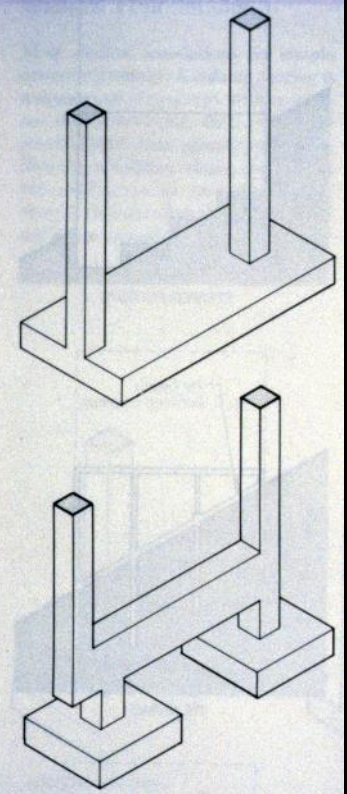
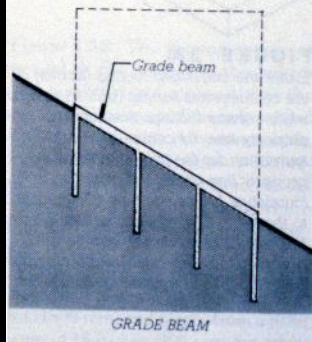
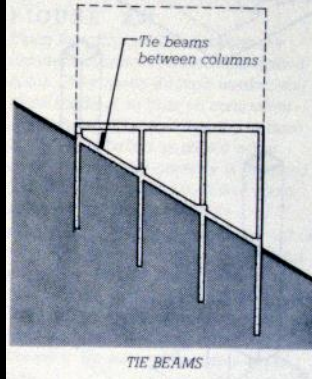
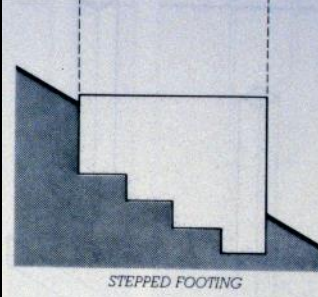
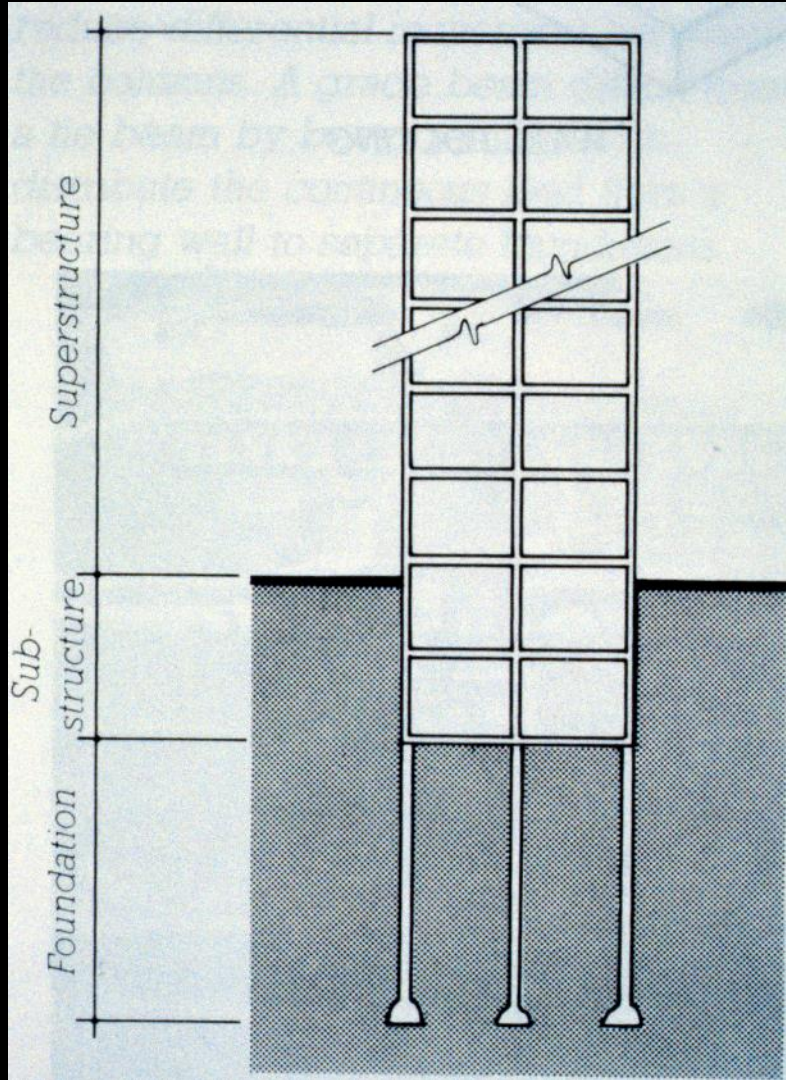

FIGURE 2.28
 Either the combined footing (above) or the cantilevered footing (below) is used when column footings must abut a property line. By combining the foundation for the column against the property line, at the left, with the foundation for the next interior column, to the right, in a single structural unit, a balanced footing design can be achieved. The concrete reinforcing 186
 has been omitted from these drawings for the sake of clarity.

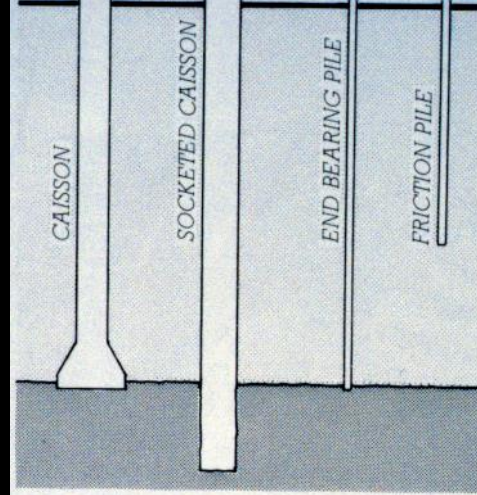

FIGURE 2.31

Deep foundations. The caissons are concrete cylinders poured into drilled holes. They reach through weaker soil (light shading) to bear on competent soil beneath. The end bearing caisson at the left is belled as shown when additional bearing capacity is required. The socketed caisson is drilled into a hard stratum and transfers its load primarily by friction between the soil or rock and the sides of the caisson. Piles are driven into the earth. The end bearing pile acts in the same way as a caisson. The friction pile derives its load-carrying capacity from friction between the soil and the sides of the pile.

Pile Foundations

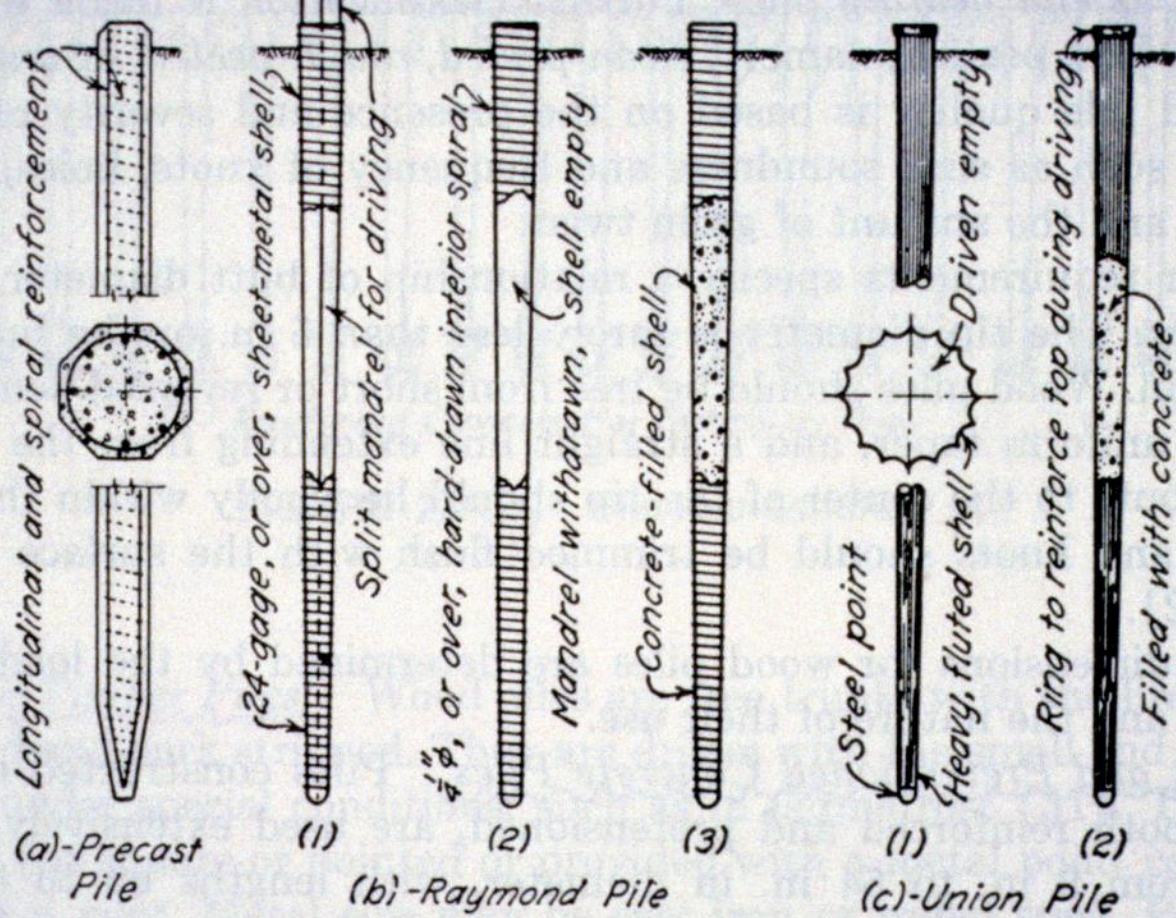
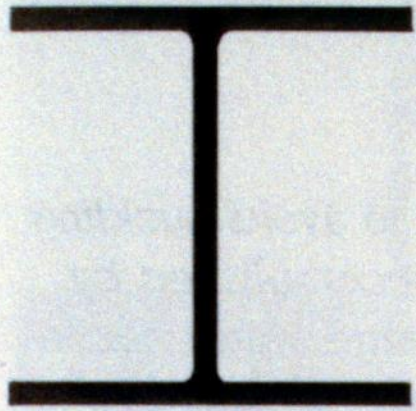
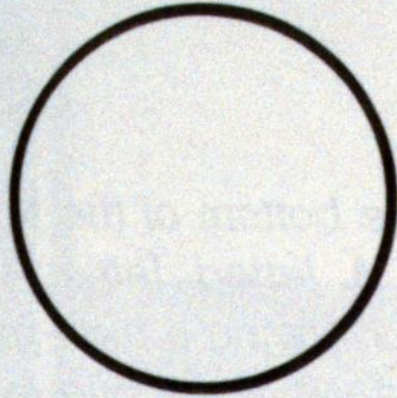

FIGURE 2.29 Precast concrete pile and cast-in-place shell piles. (a) Precast pile. (b) Raymond pile. (c) Union pile.



STEEL H-PILE



STEEL PIPE PILE

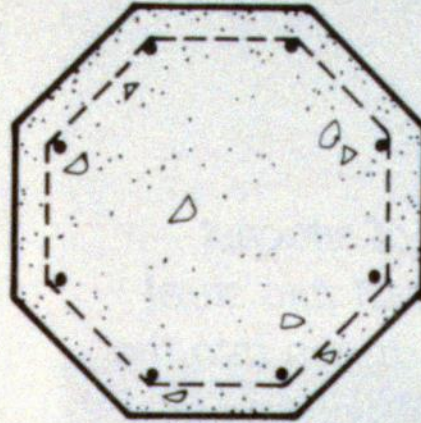

*PRECAST
CONCRETE PILE*

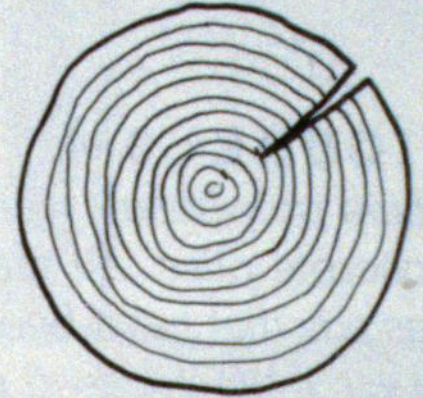

WOOD PILE



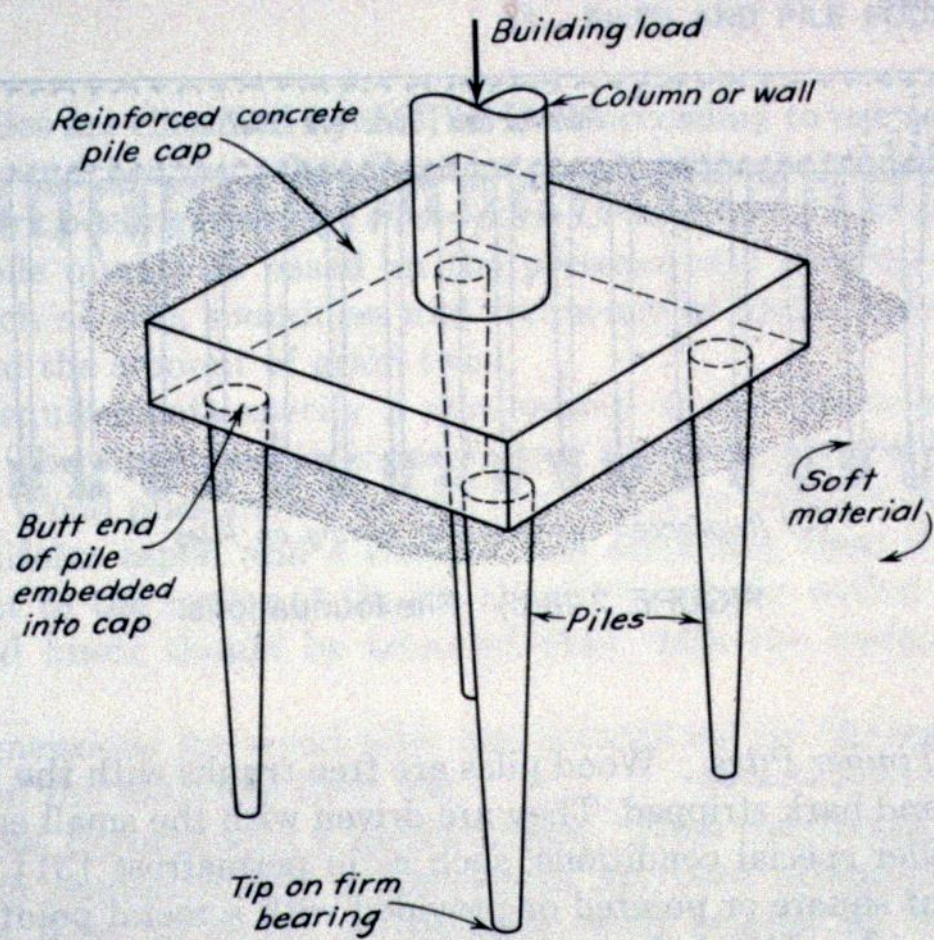

FIGURE 2.28(a)* Isolated pile foundation.

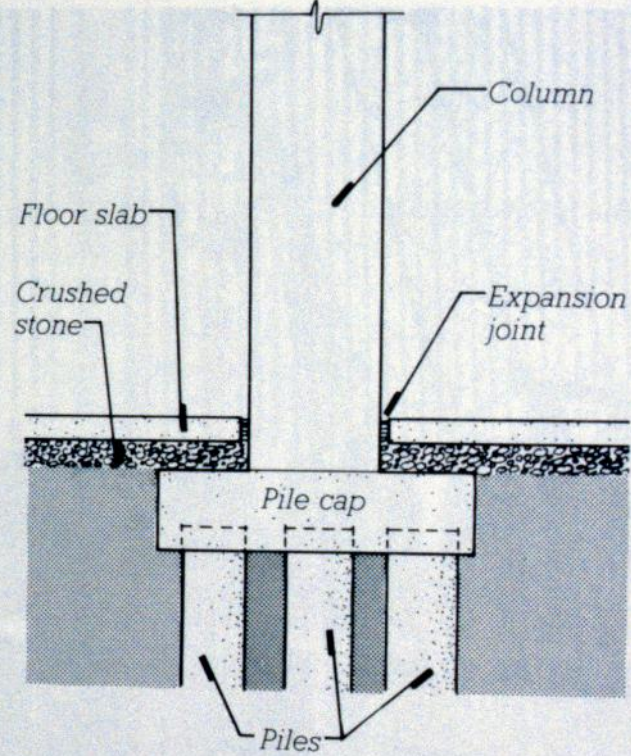

FIGURE 2.37

An elevation view of a pile cap, column, and floor slab. Where possible, the cap is poured against earth sides, as shown, for economy and for better resistance to lateral loads.

FIGURE 2.38

A single friction pile (left) transmits its load into the earth as an equal pressure along the bulb profile indicated by the dotted line. As the size of the pile cluster increases, the piles act together

to create a single, larger bulb that reaches deeper into the ground. A building with many closely spaced clusters of piles (right) creates a very large, deep bulb. Care must be taken

on some sites to be sure that pressure bulbs do not become so large as to extend completely through a stratum of competent soil into softer or less stable material beneath.

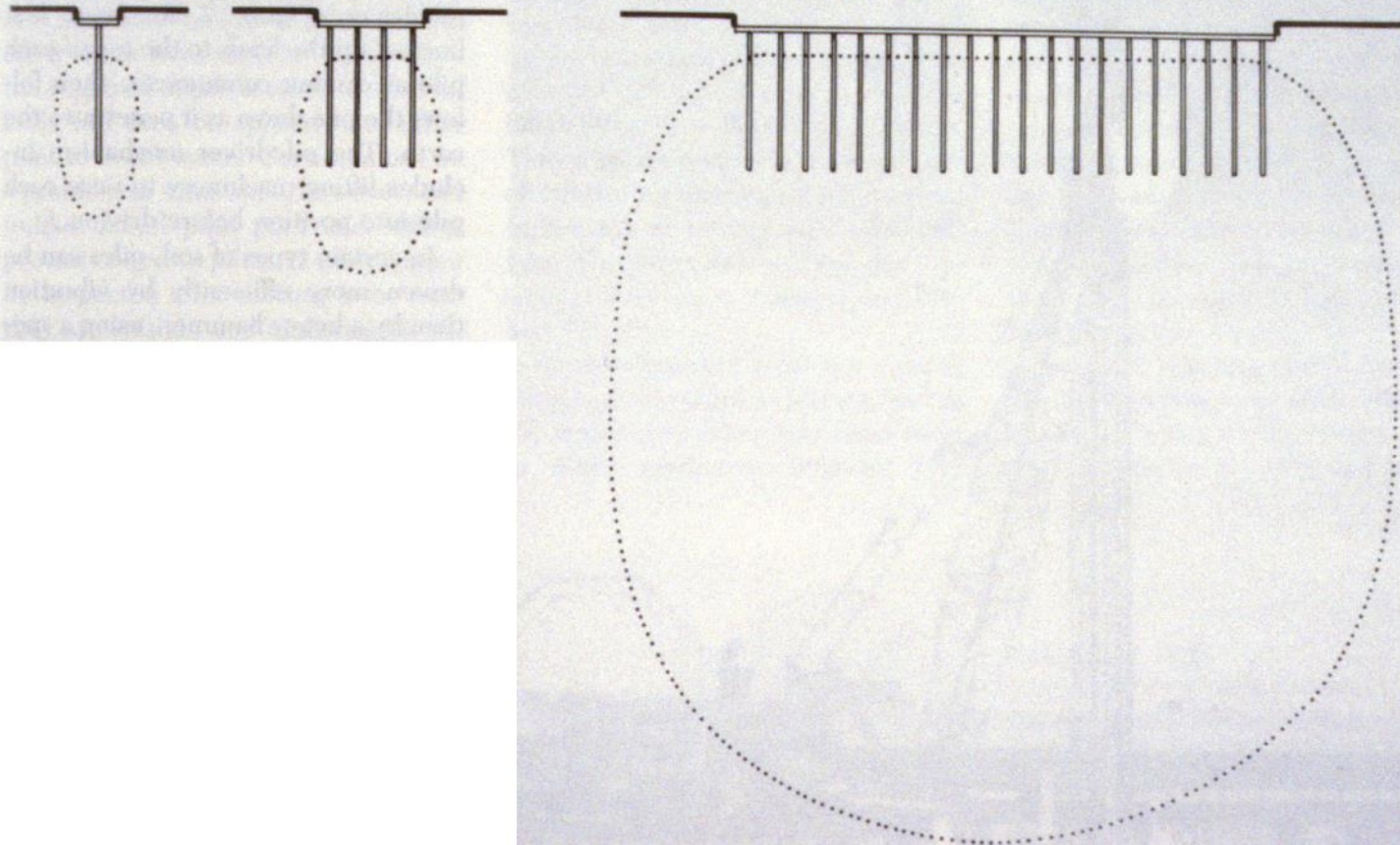



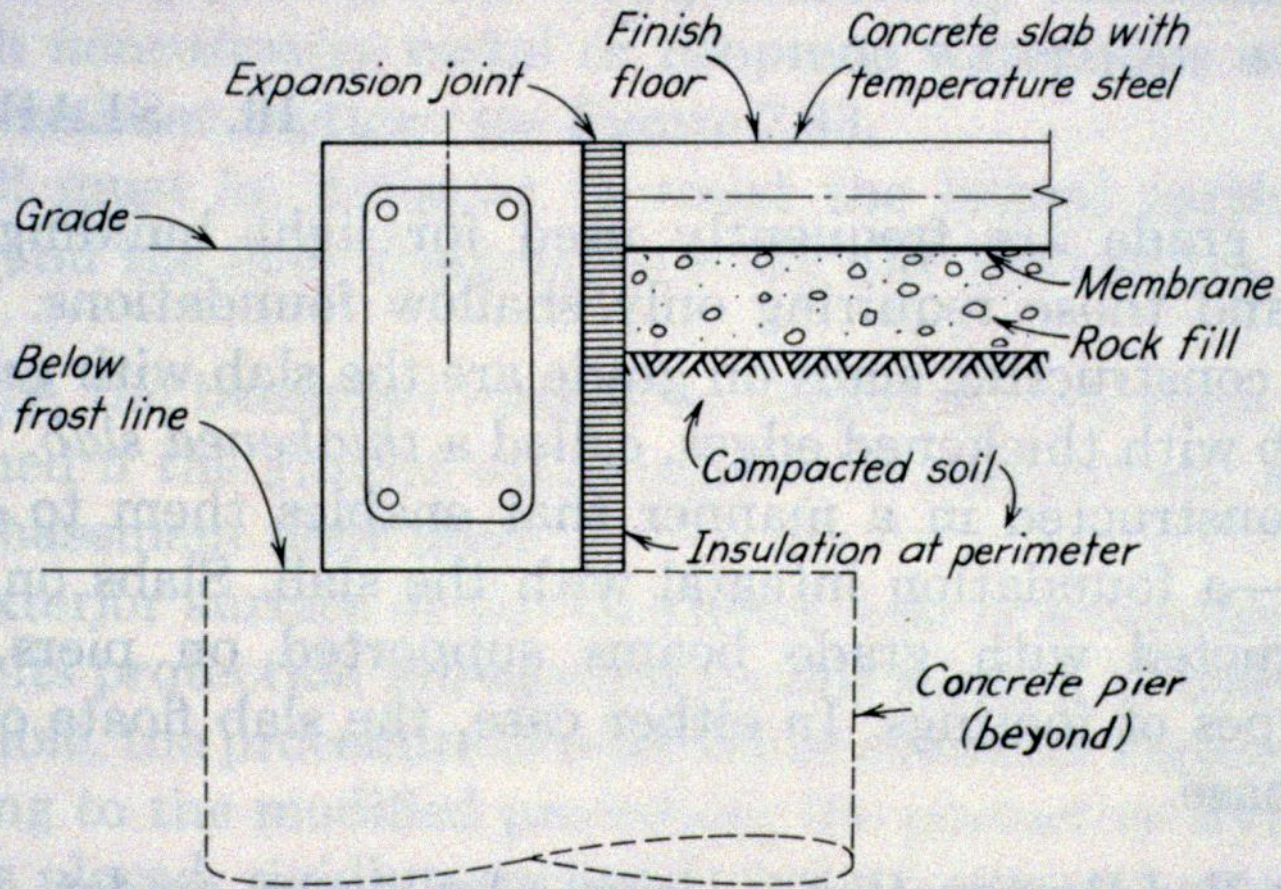
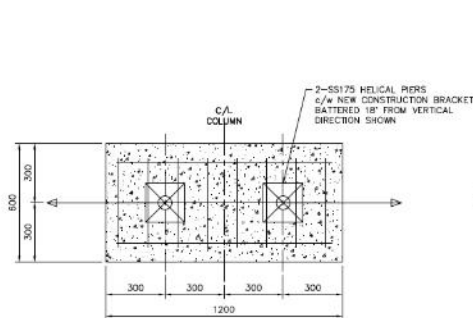

FIGURE 2.64 Grade beams.









PLAN

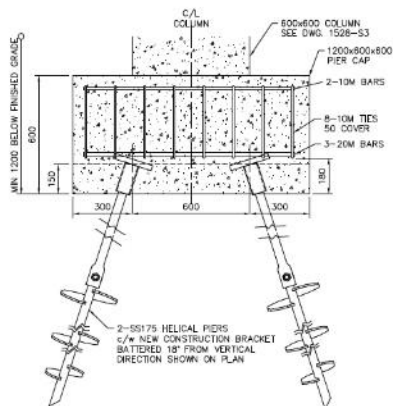

ELEVATION

PIER CAP TYPE 'PC1'
TOTAL 6 LOCATIONS
2-SS175 HELICAL PIERS PER PIER CAP

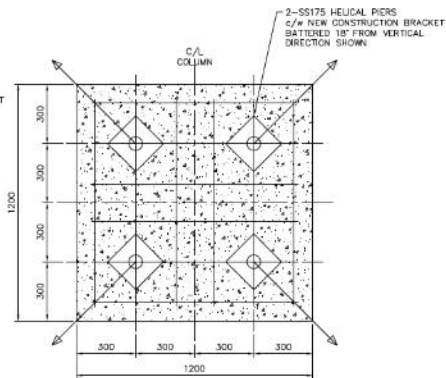

PLAN

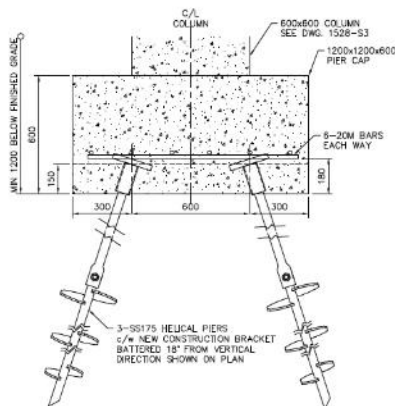

ELEVATION

PIER CAP TYPE 'PC2'
TOTAL 5 LOCATIONS
3-SS175 HELICAL PIERS PER PIER CAP

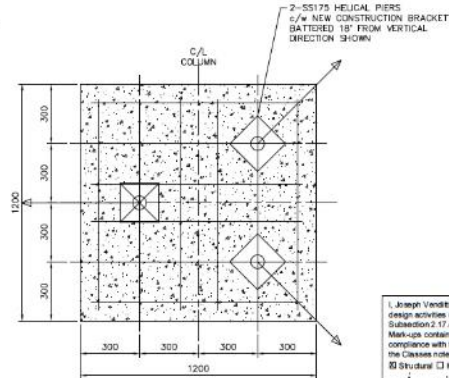

PLAN

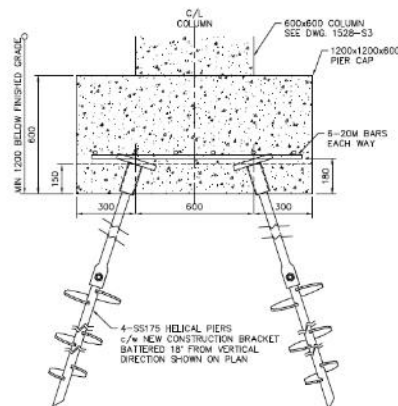

ELEVATION

PIER CAP TYPE 'PC3'
TOTAL 4 LOCATIONS
4-SS175 HELICAL PIERS PER PIER CAP

I, Joseph Venditti declare that I have reviewed and take responsibility for the design activities checked below on behalf of a firm registered under Subsection 2.17.4 of the Ontario Building Code. These drawings and any Mark-ups contained herein are believed, to the best of my knowledge, to be in compliance with the O.B.C. I am Qualified and the Company is registered in the Classes noted below. C3 Venditti Engineering Limited BCN 31153
 Structural House

Joseph Venditti
BCN 22510
06/15/07
Dwg. (MMD/DTY)

NO.	DATE	REVISION
0	06/15/07	ISSUED FOR PERMIT



C3 VENDITTI
Engineering Limited
365 Woodbine Street South, Brantford, Ontario N6B 1M0
Telephone: (519) 646-0394 Fax: (519) 646-0325
Email: j.venditti@cg3group.com

PROJECT
GRAND HOUSE STUDENT CO-OP
HELICAL PIER UNDERPINNING

Cambridge, Ontario

DRAWING
PIER CAP DETAILS

DRAWN BY TDO	SCALE: NTS
CHECKED JMV	DATE: Jun. 15, 2007
PROJECT No. 1528	DWG. No. S2













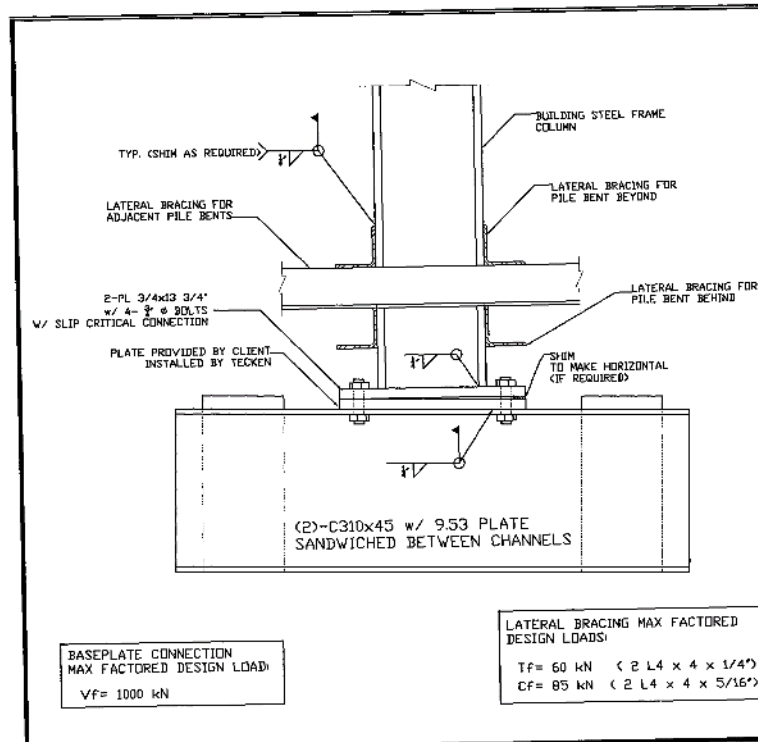

Tecken Building Corp

175A Beverly St. Bay #3
Cambridge, Ontario N1R 7Y9
Tel: 519.624.9377 Fax: 519.624.6937

	Project	THE GRAND HOUSE CAMBRIDGE, ONTARIO	Scale	NTS	1
	Drawing	MICROPILE CONNECTION DETAIL	Date	OCTOBER '07	
	Location	CAMBRIDGE, ON	Drawn By	B.W.	
			Project No.	7041	

Caisson Foundations

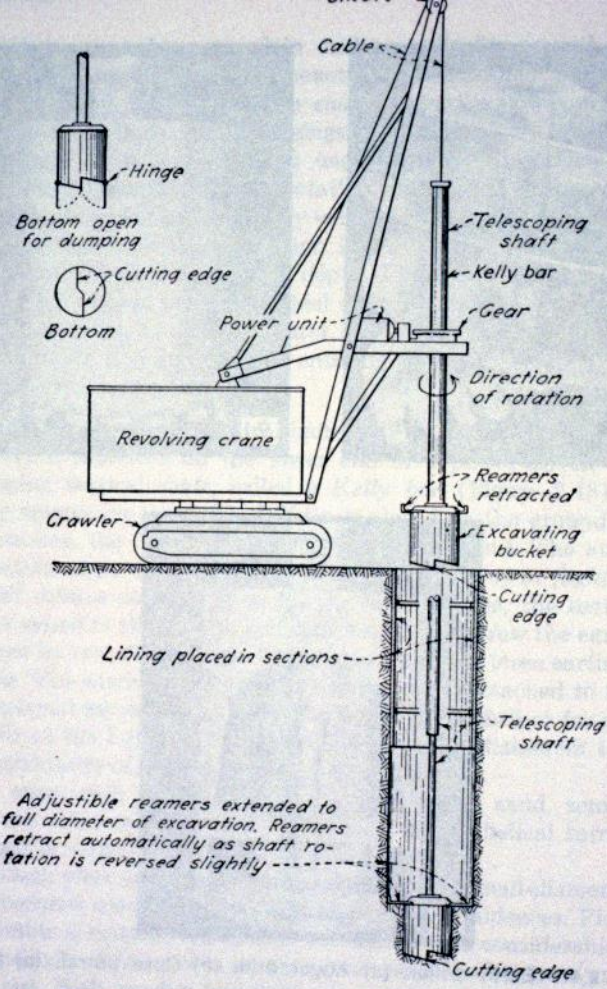
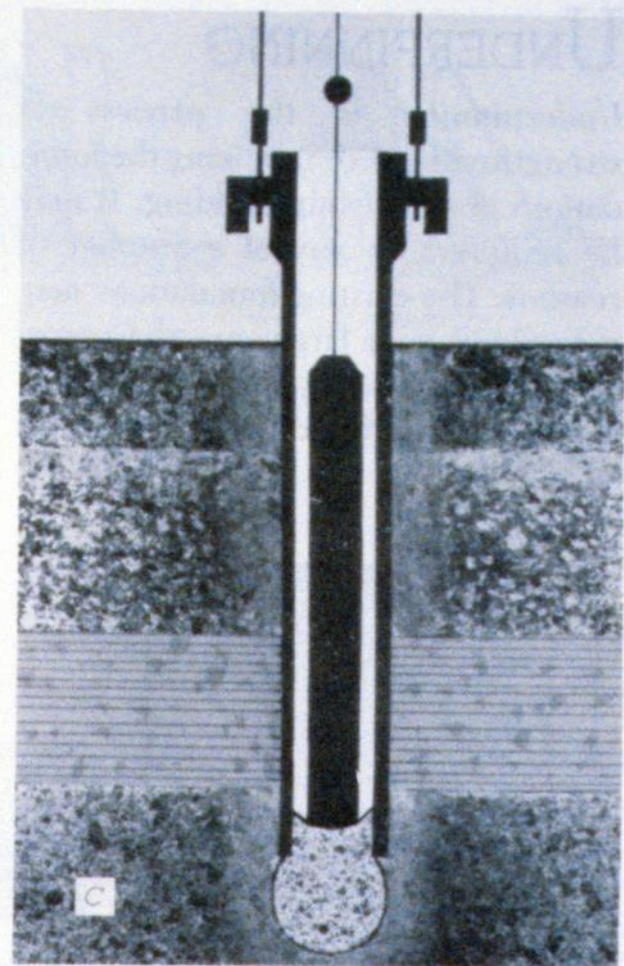
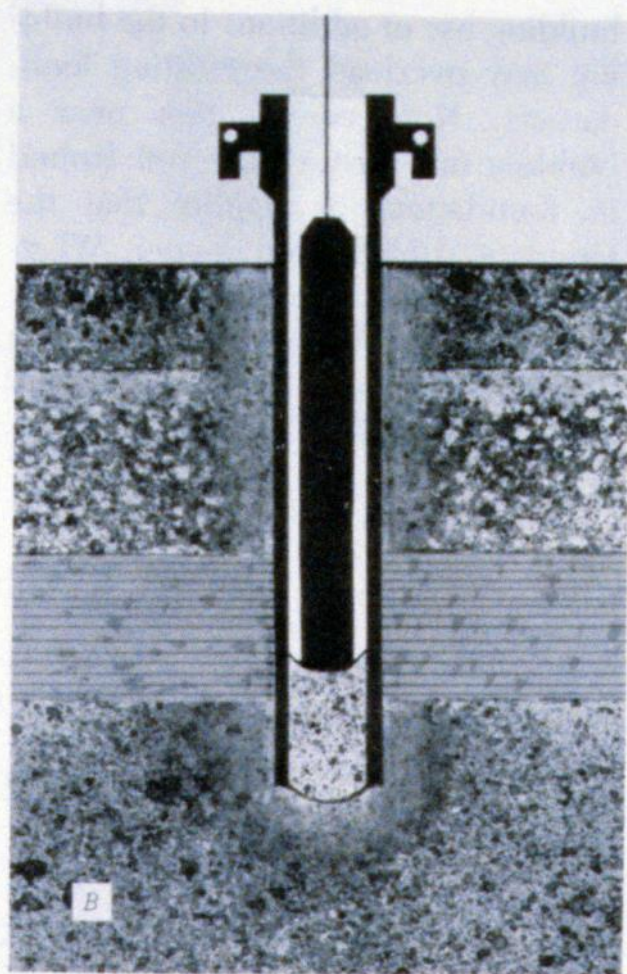
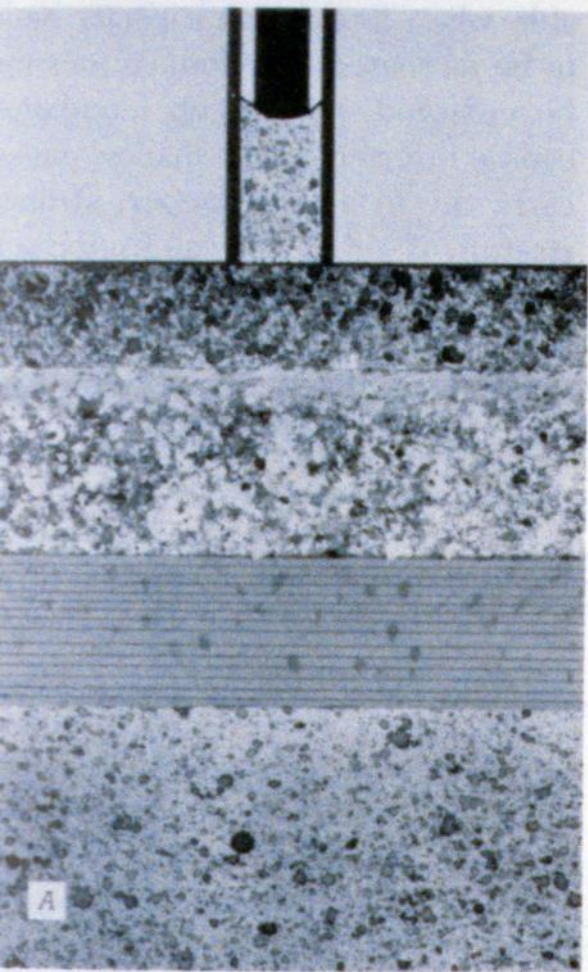

FIGURE 2.48 Well bored in clay with bucket drill.































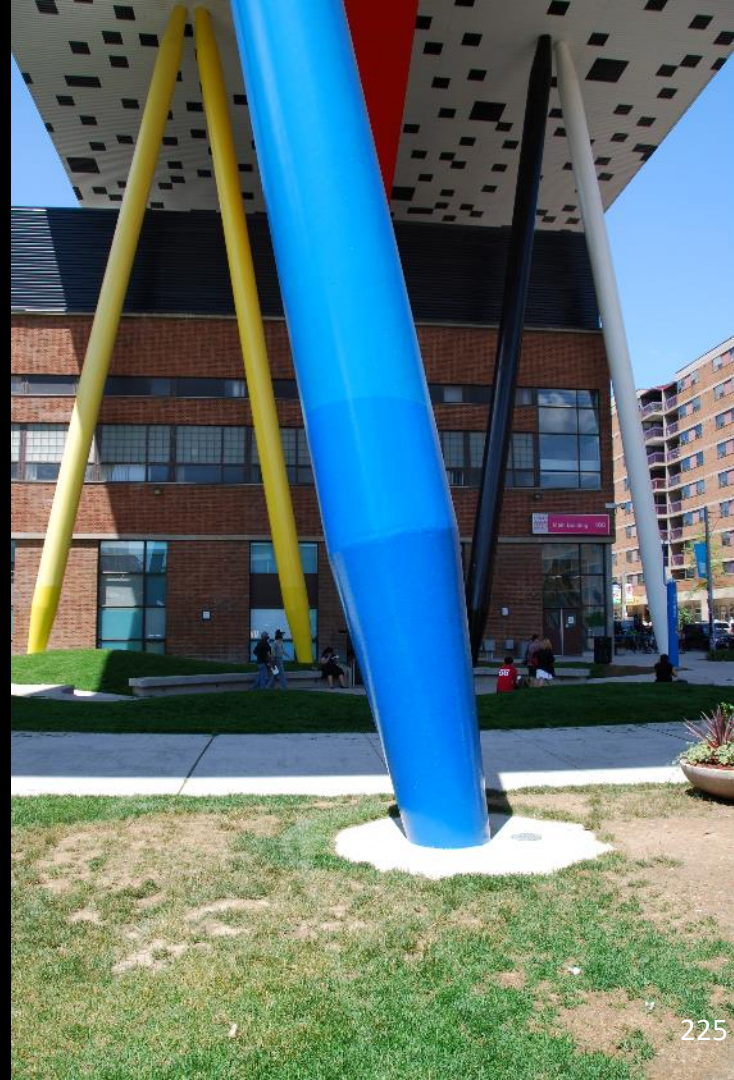

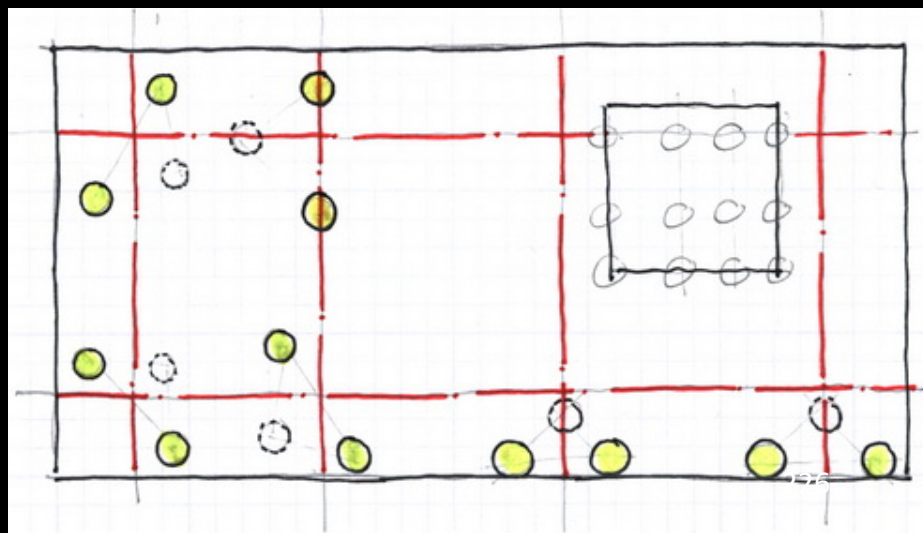
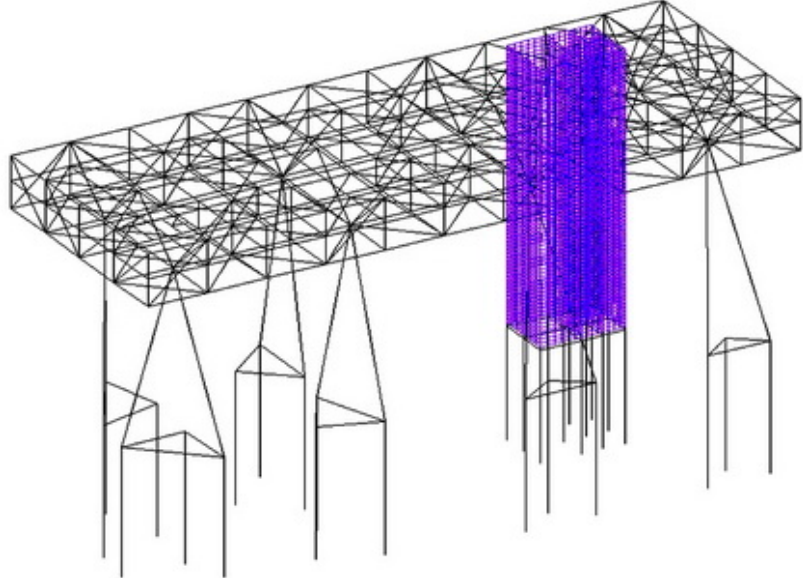





2003 7 24



Raft Slabs/ Floating Foundations

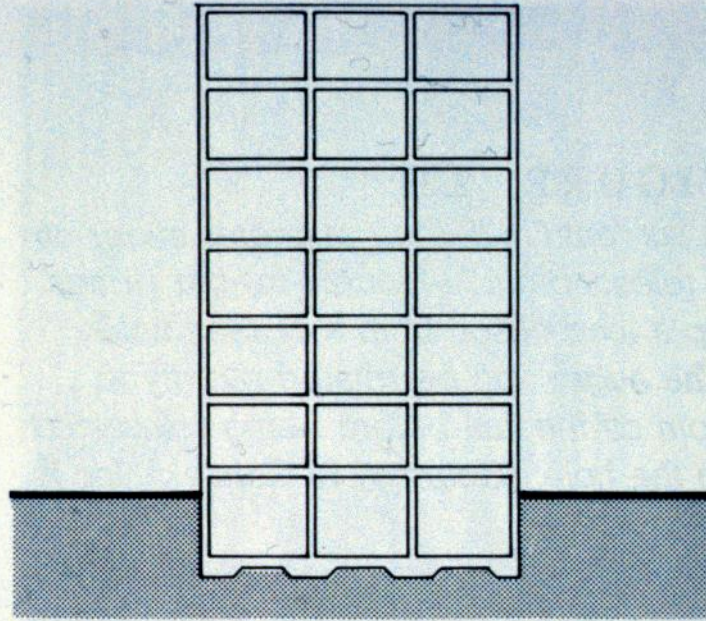

FIGURE 2.30

A cross section through a building with a floating foundation. The six stories of superstructure weigh approximately the same as the soil excavated for the substructure, so the stress in the soil beneath the building has not changed.













Retaining Walls

- Rugged Quarried Stone Appearance
- Steel & Fiber Reinforced Solid Concrete
- Large 16" x 32" Facing Area
- Engineered Design

- Easy to Install
- Low Cost

Call: (877) 901-9998

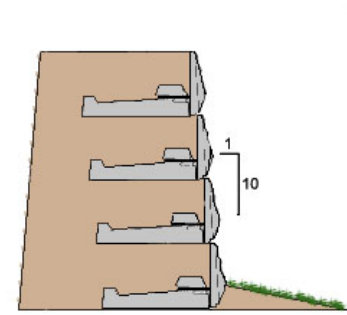

Std. 1:10 Batter Wall

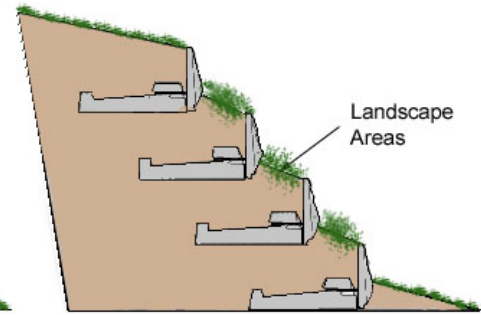

Tiered Wall of Single Stone Rows

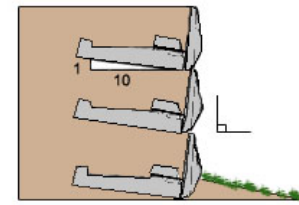

True Vertical Wall Face

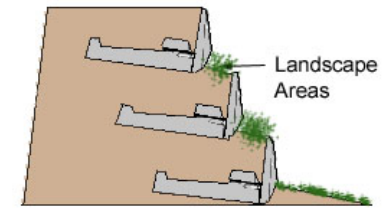

Negative Batter with Offset

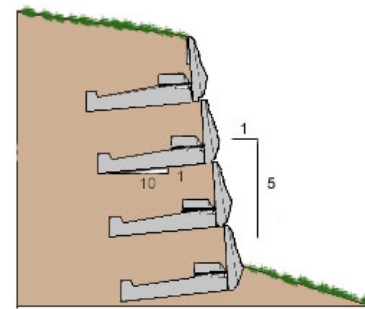

5V/1H Battered Wall Face

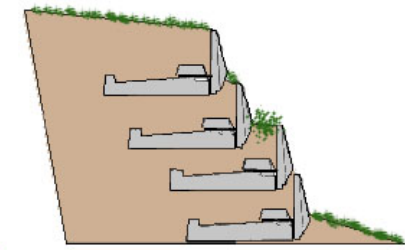

Varied Vertical & Horizontal Offsets







Underpinning

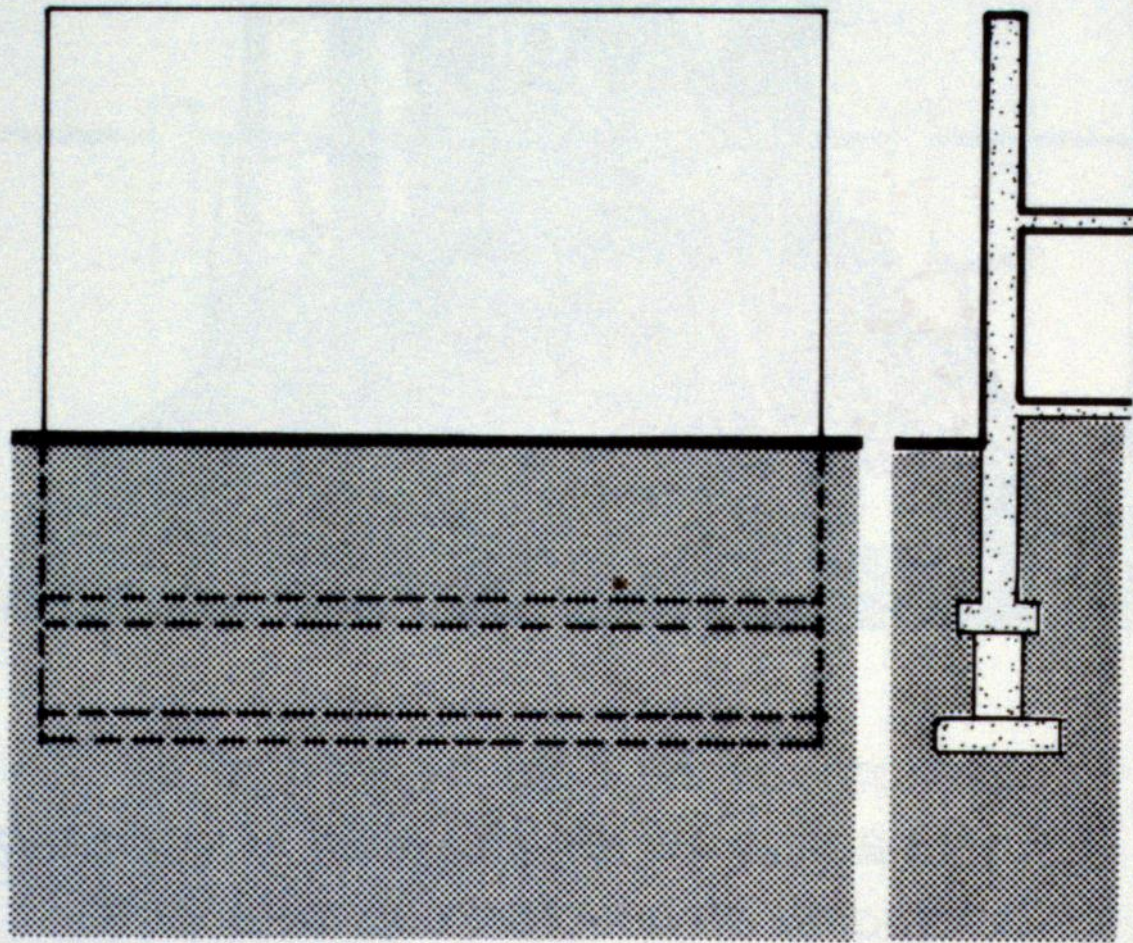

A. ELEVATION

SECTION

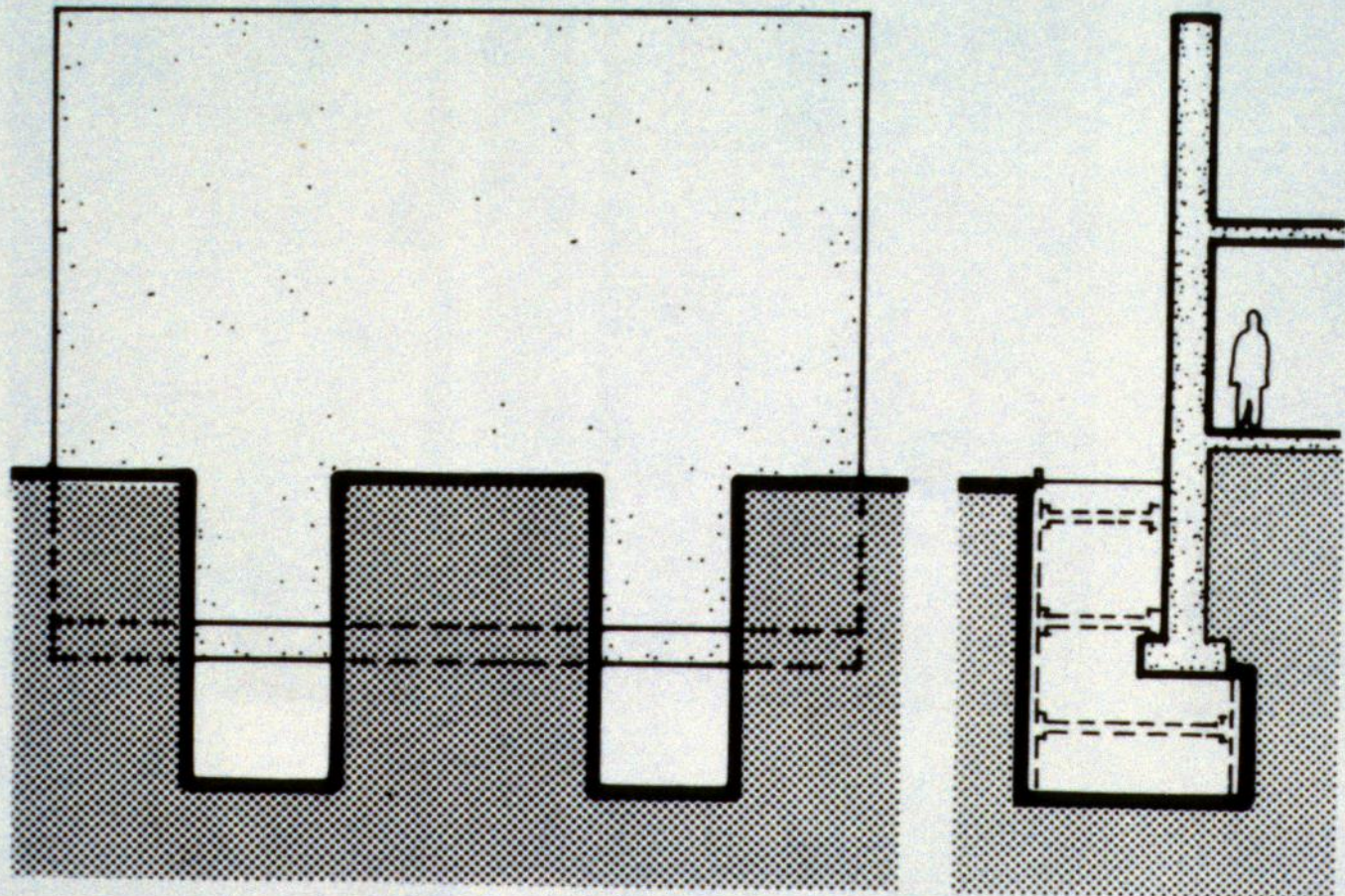

A. ELEVATION

SECTION

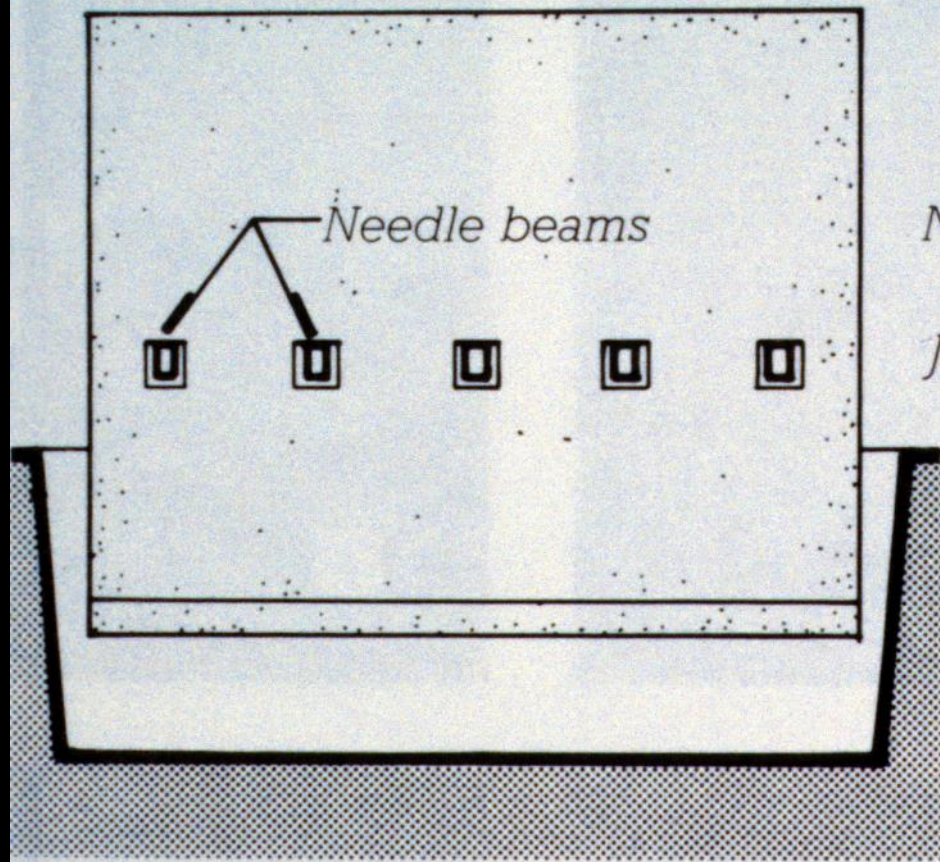

B. ELEVATION

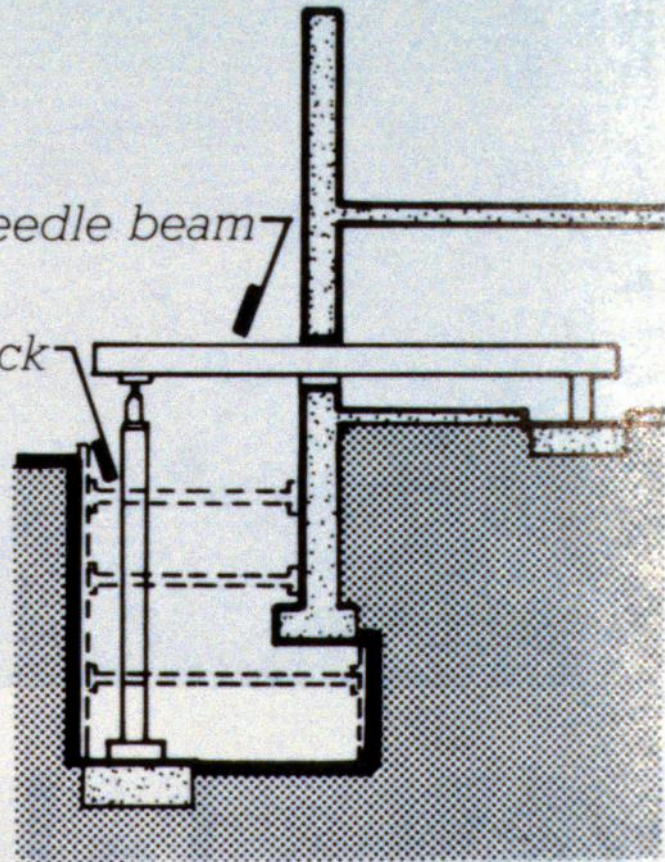

SECTION

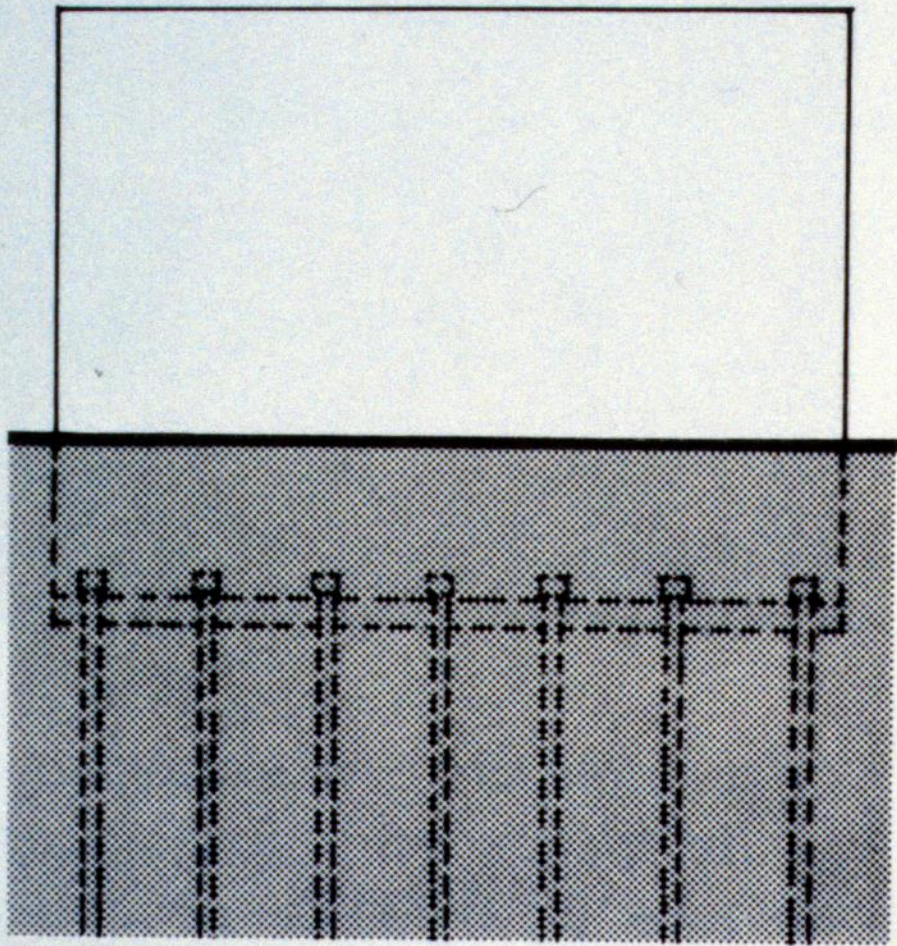

B. ELEVATION

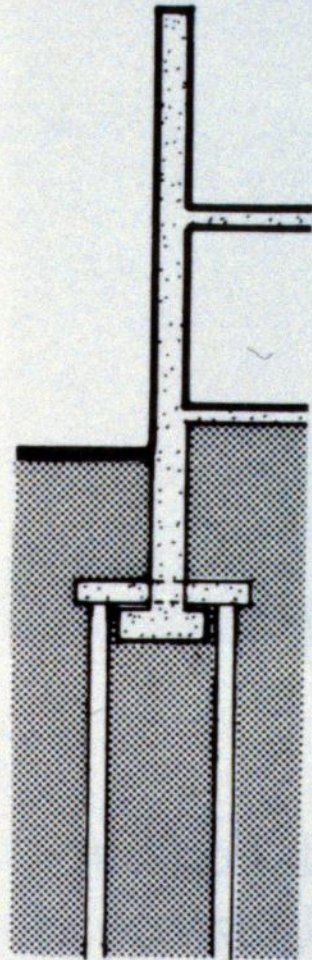

SECTION

 COUNSEL TRUST COMPANY
865-9365

 Strong Associates
Architects

JABLONSKY ASSOCIATES
TORONTO
CONSULTING ENGINEERS

 GENERAL CONTRACTOR
489-4809
TACTIX

CIATES
ENGINEERS

 COUNSEL TRUST COMPANY
865-9365

 GENERAL CONTRACTOR
489-4809
TACTIX

POST
NO BILLS





