

Arch 173: Building Construction 2

THE THIRD SKIN – Building Science Part 2

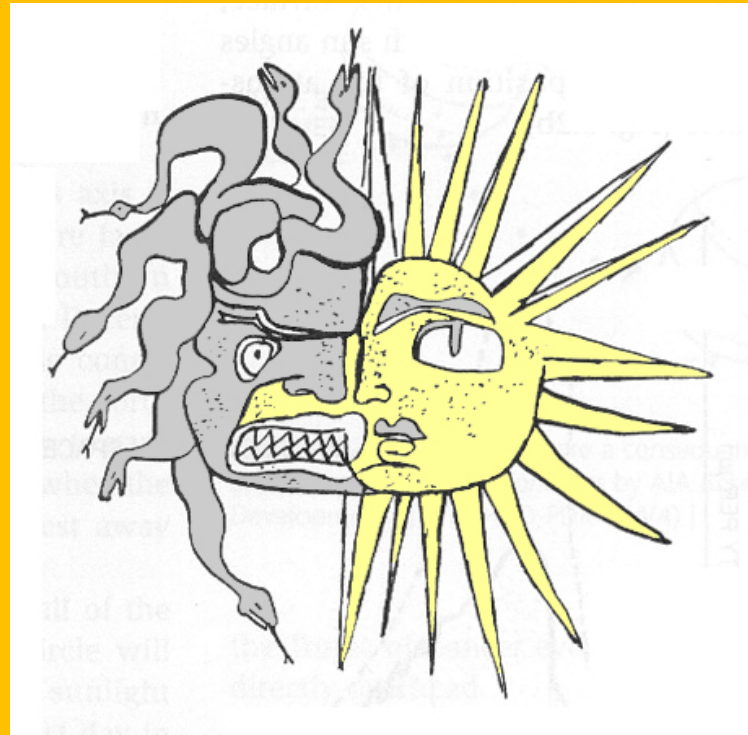

The Building Envelope –
where Building Construction meets
Environmental Design

The First Skin

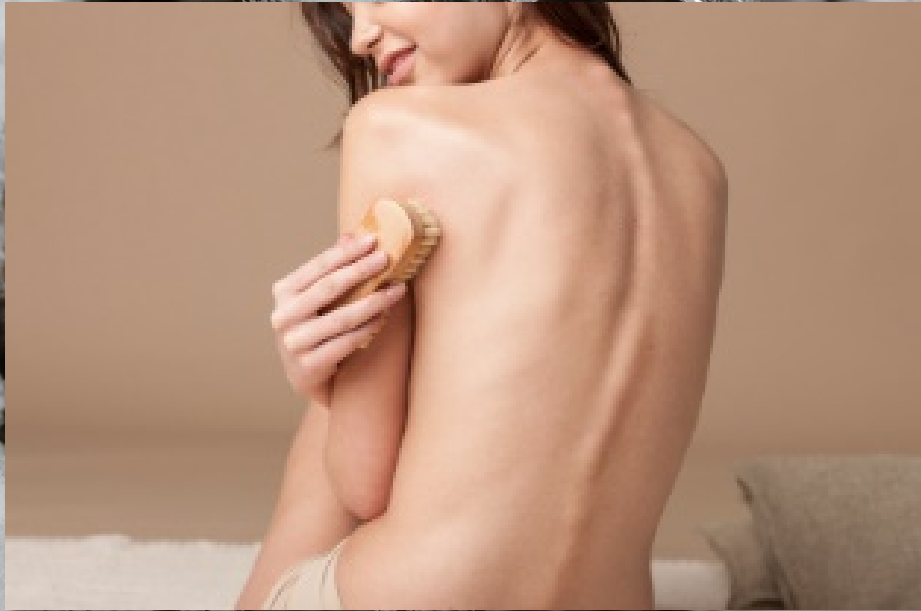

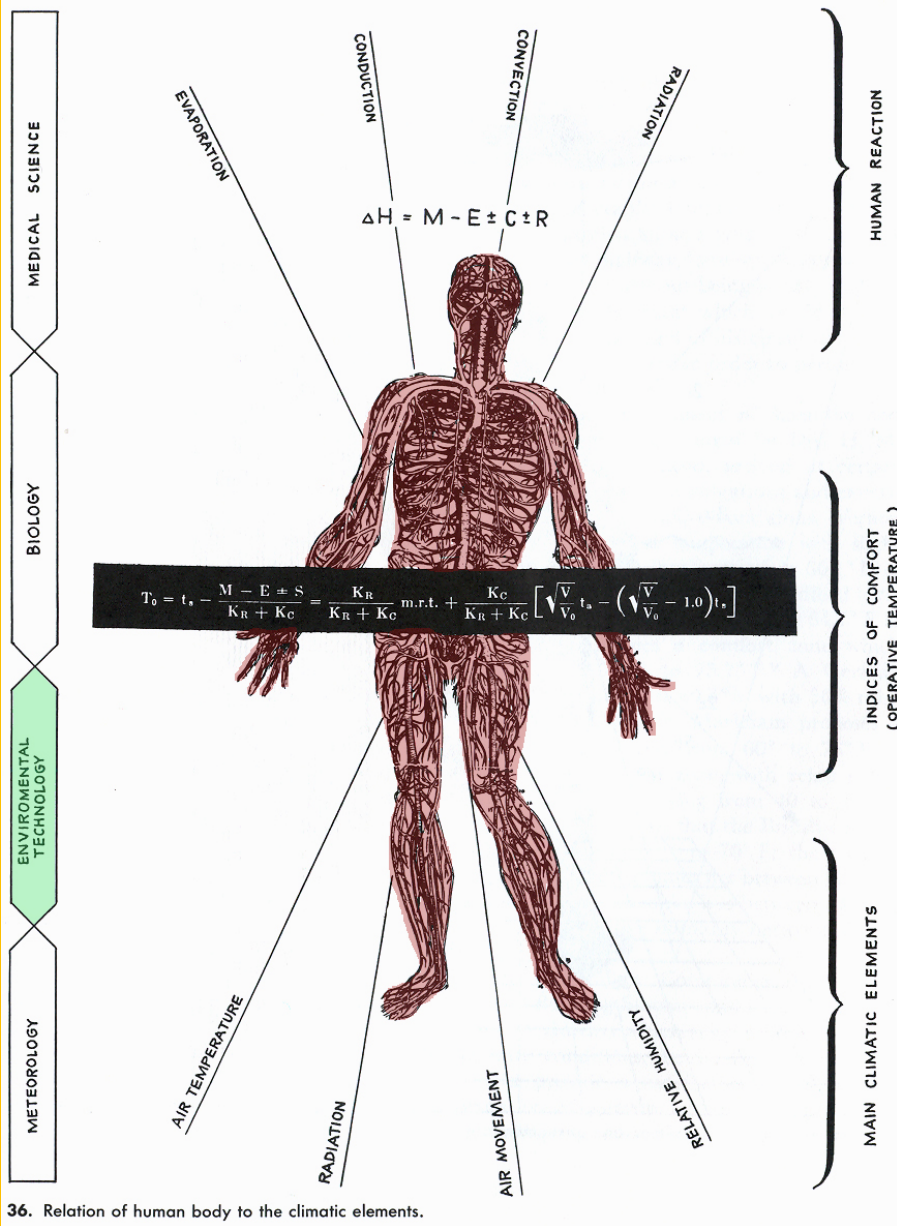

36. Relation of human body to the climatic elements.

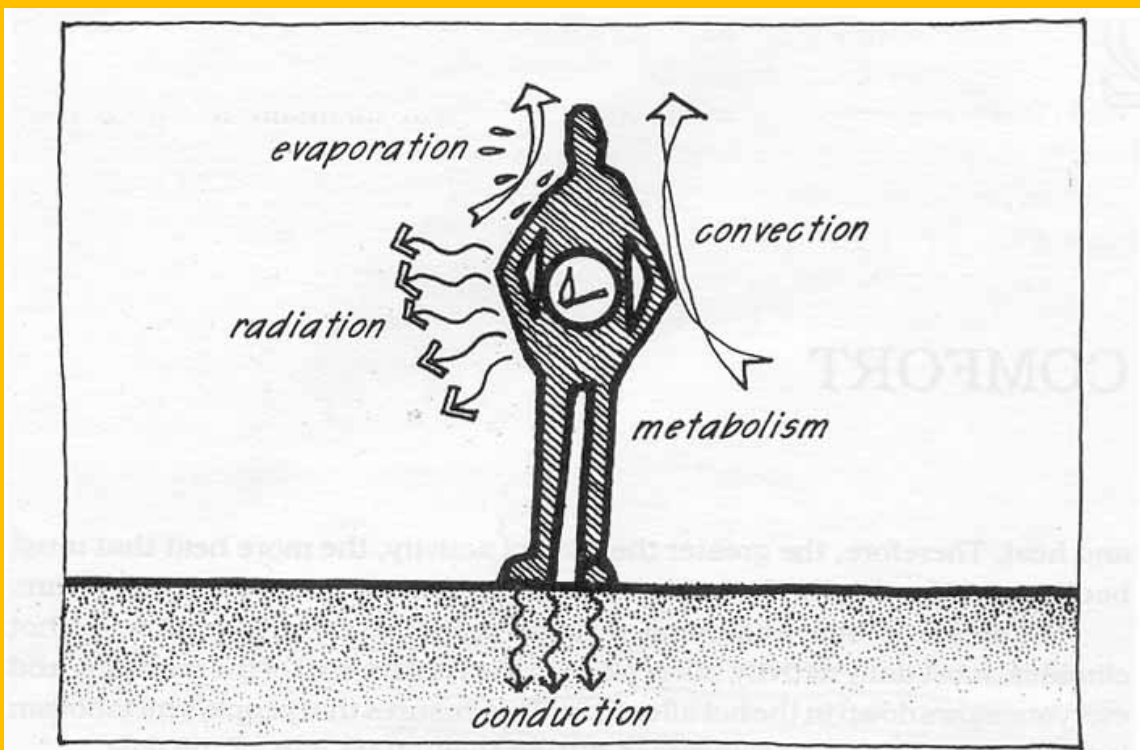
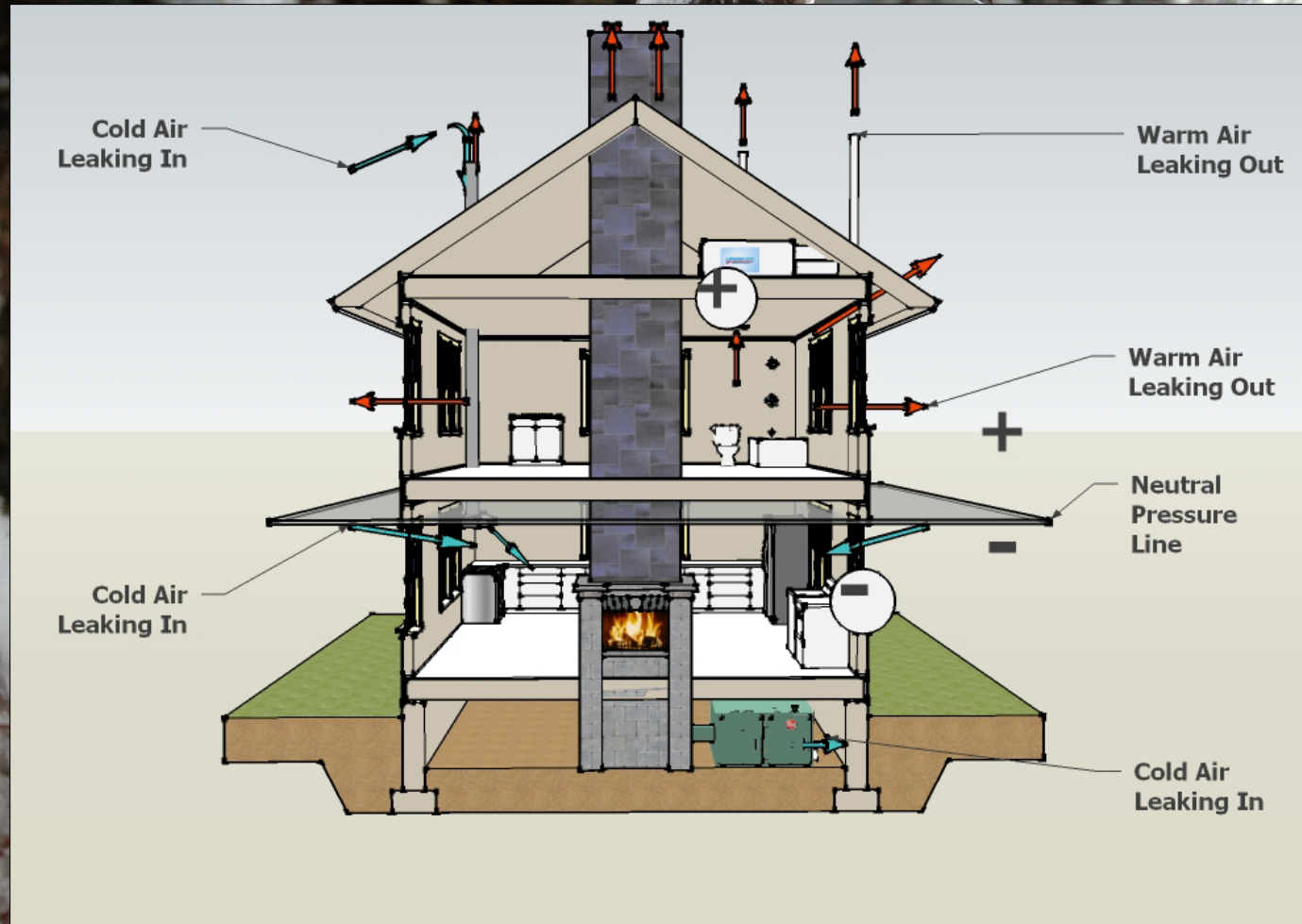

Figure 2.1: Maintaining the thermal balance by equalizing heat gain (due primarily to metabolic heat generation) and heat losses (by convection, radiation, conduction, and evaporation).

The Second Skin



The Third Skin



©IBE 213 All Rights Reserved IBE, Baker-Laporte, Collette

The Third Skin

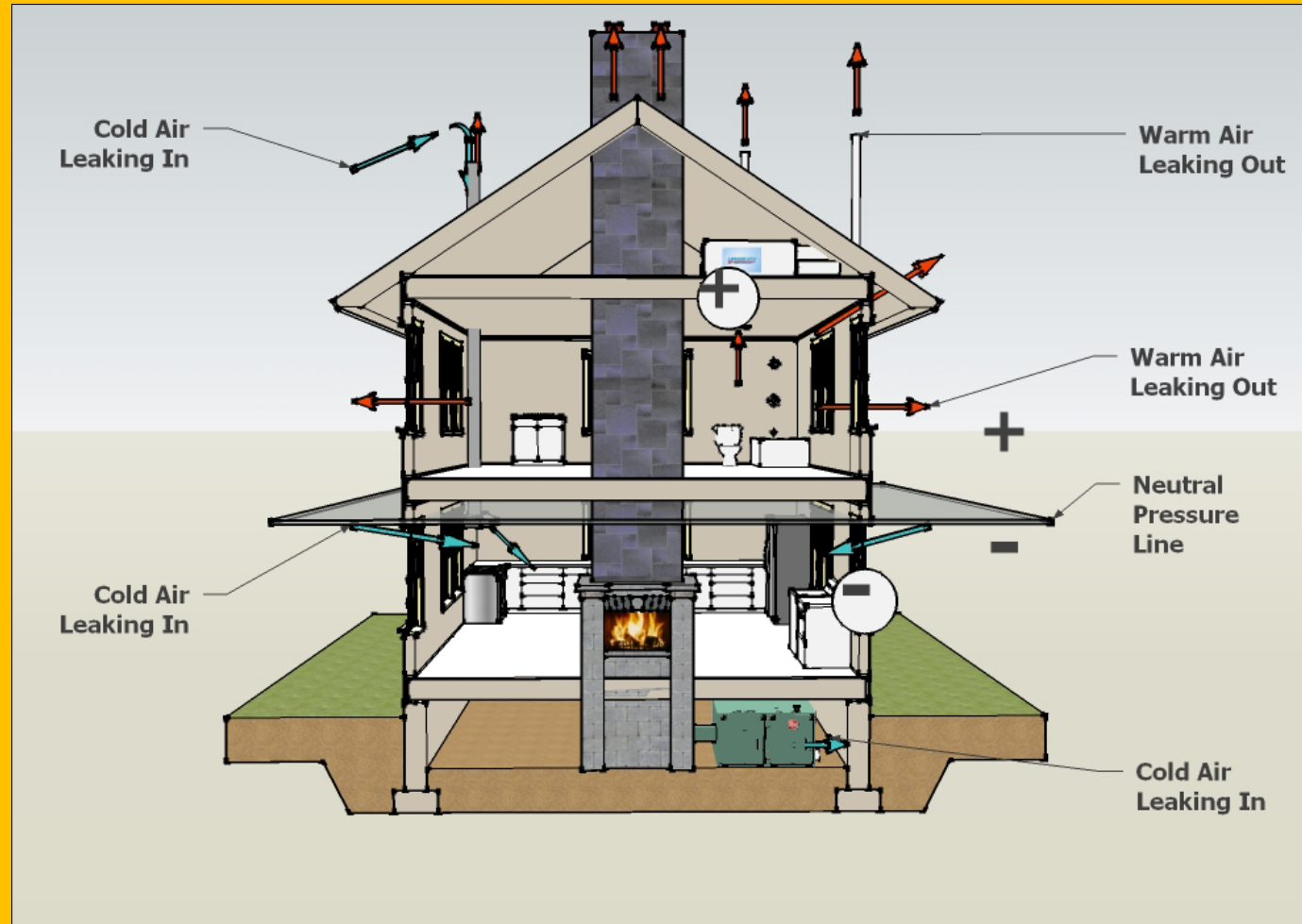

©IBE 213 All Rights Reserved IBE, Baker-Laporte, Collette

The building envelope, aka third skin, must mediate between the environment and our second skin to make us comfortable.

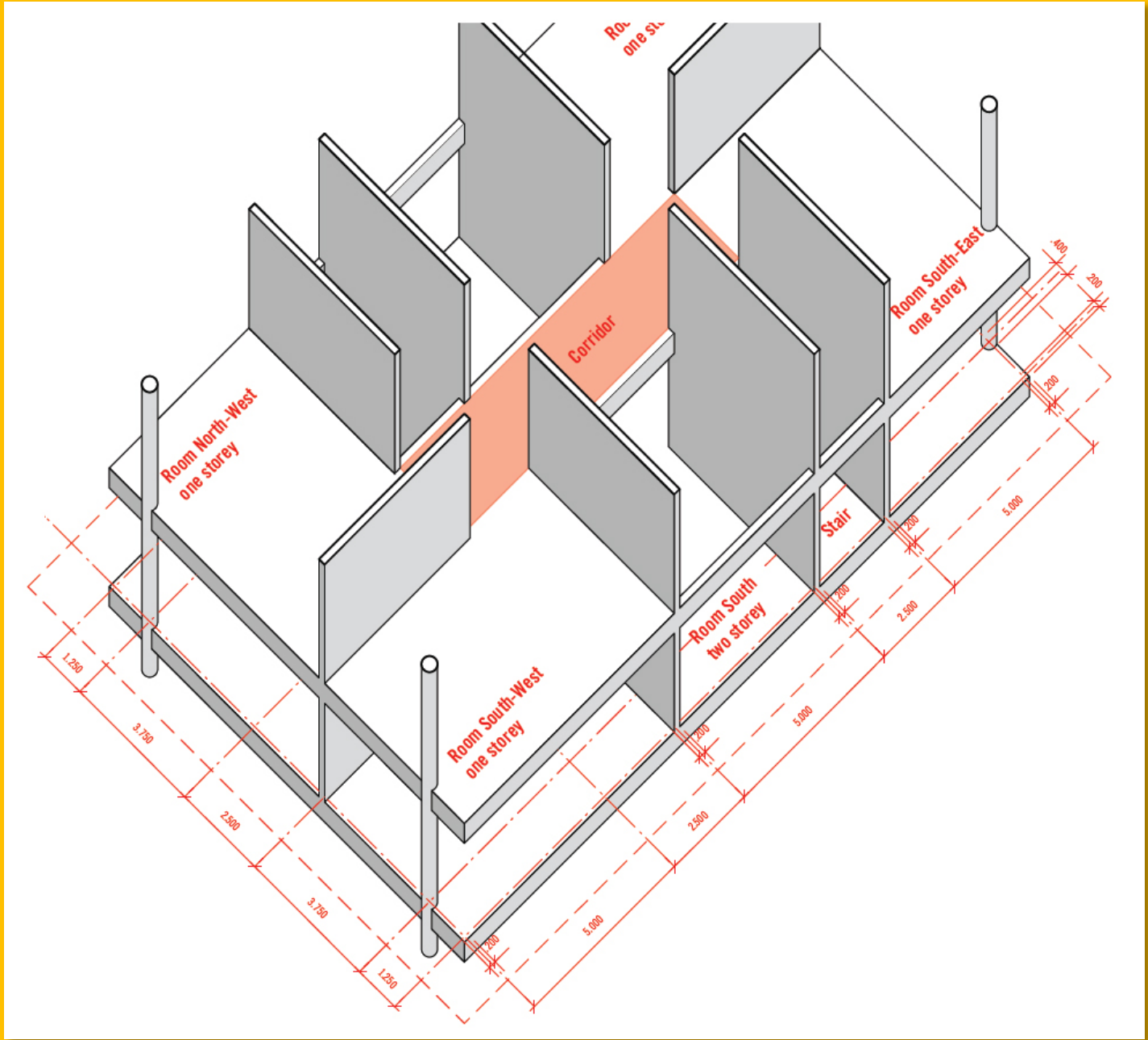

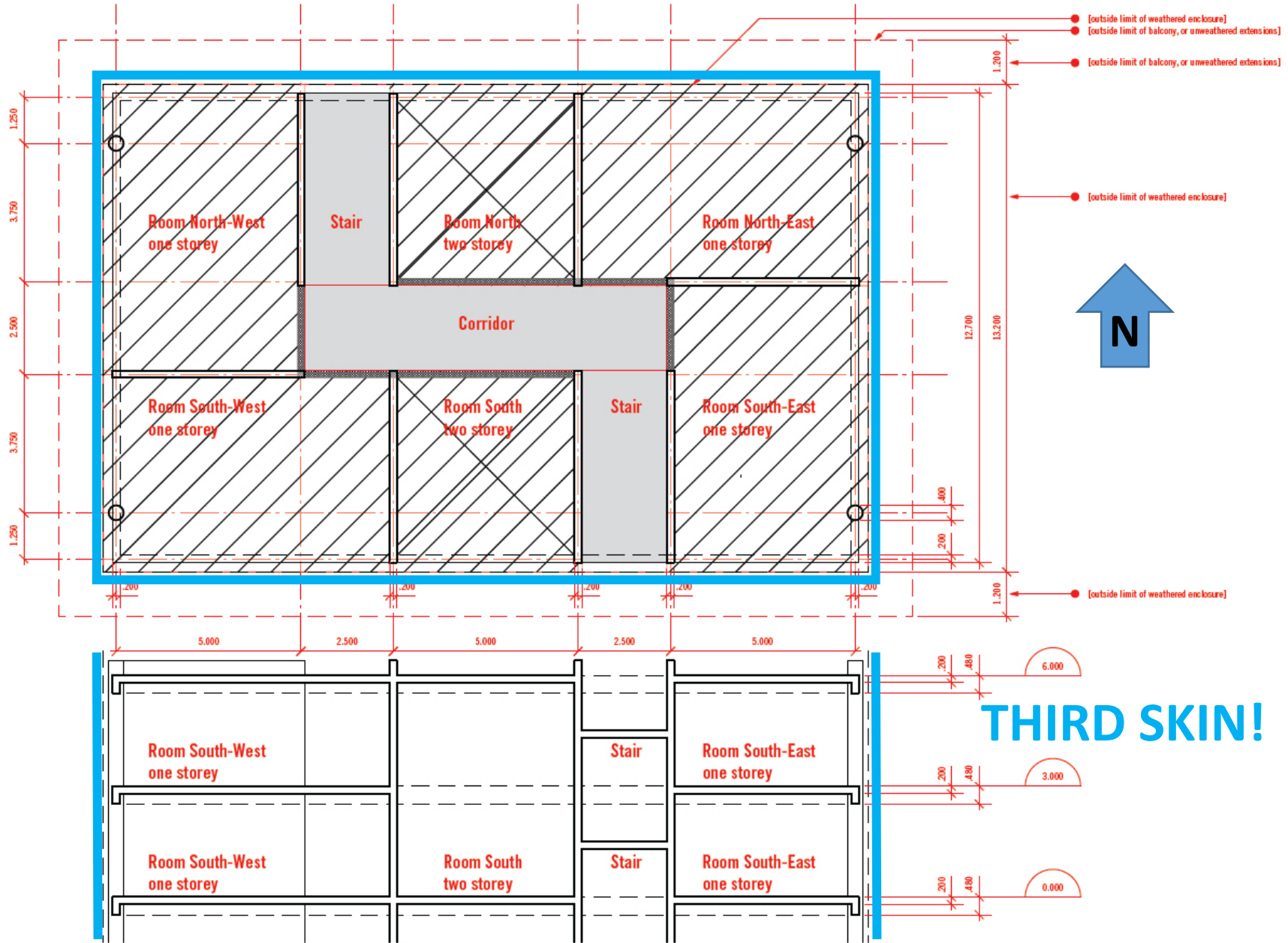

The Third Skin is composed of:

#1 – opaque elements

#2 – transparent elements

#3 – the details that join them

The Third Skin is supposed to:

#1 – Manage climate (heat, cold, sun, light, breezes)

#2 – Be durable

#3 – Look good!

Heat Transfer Mechanisms

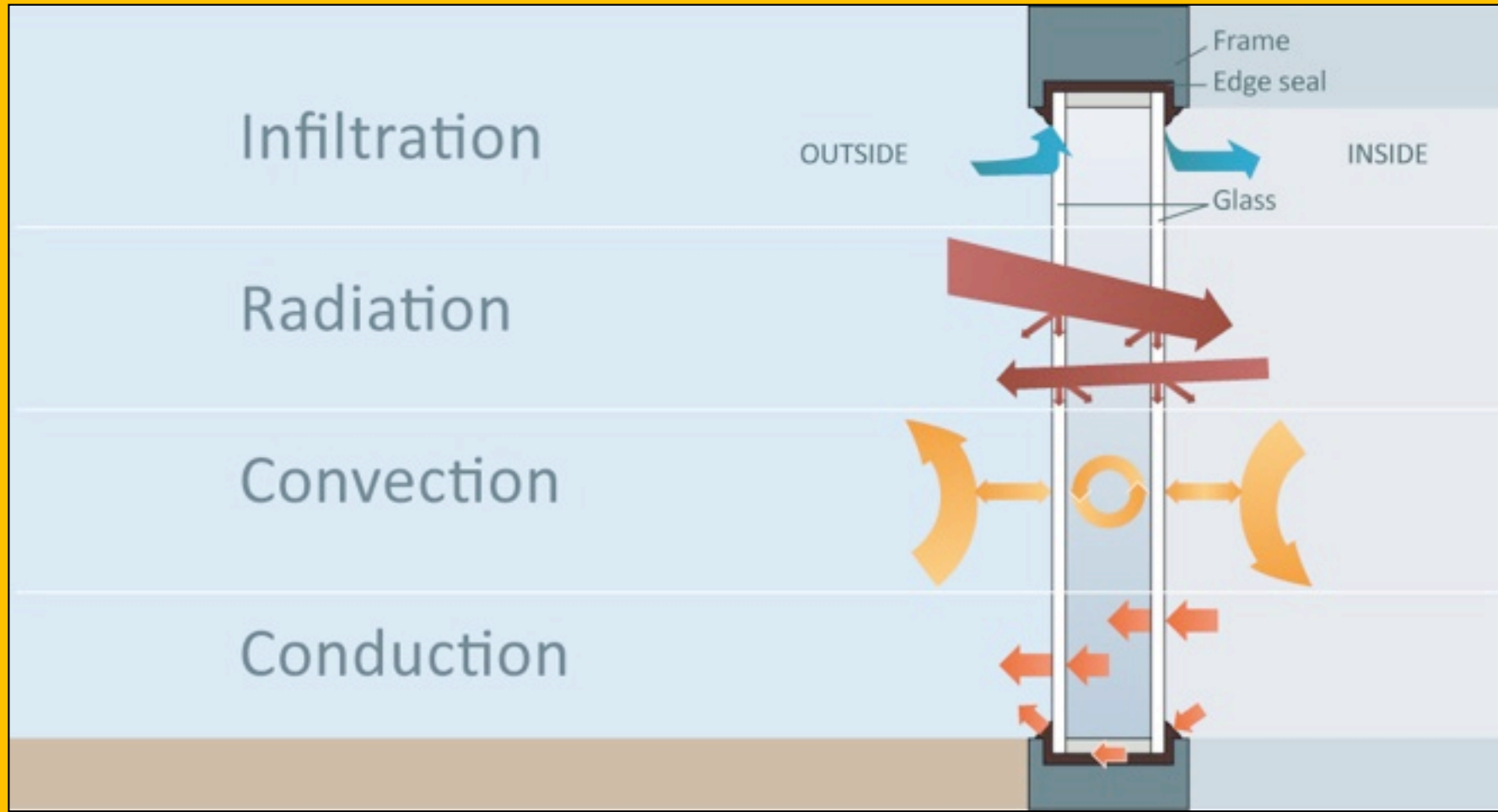
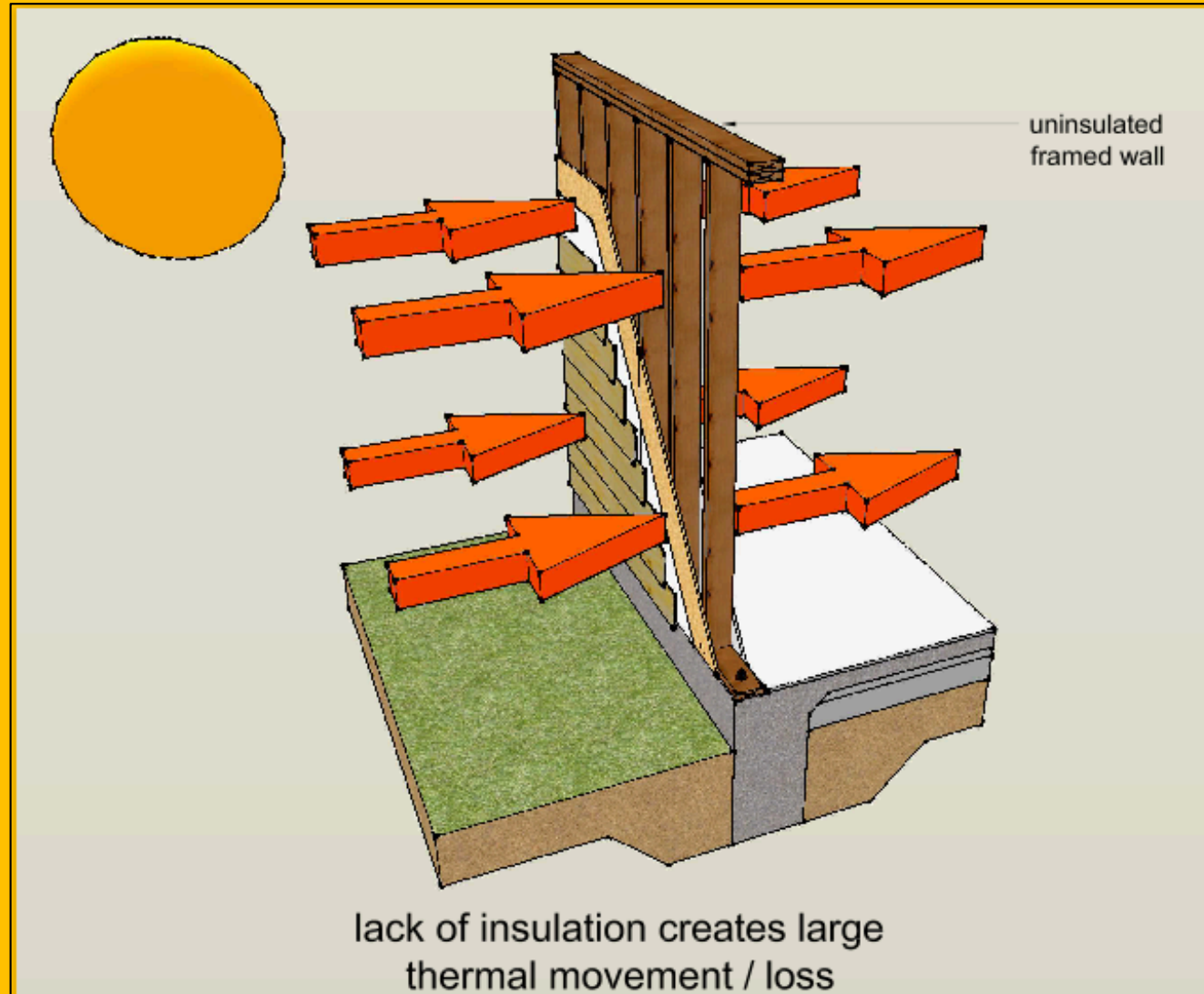
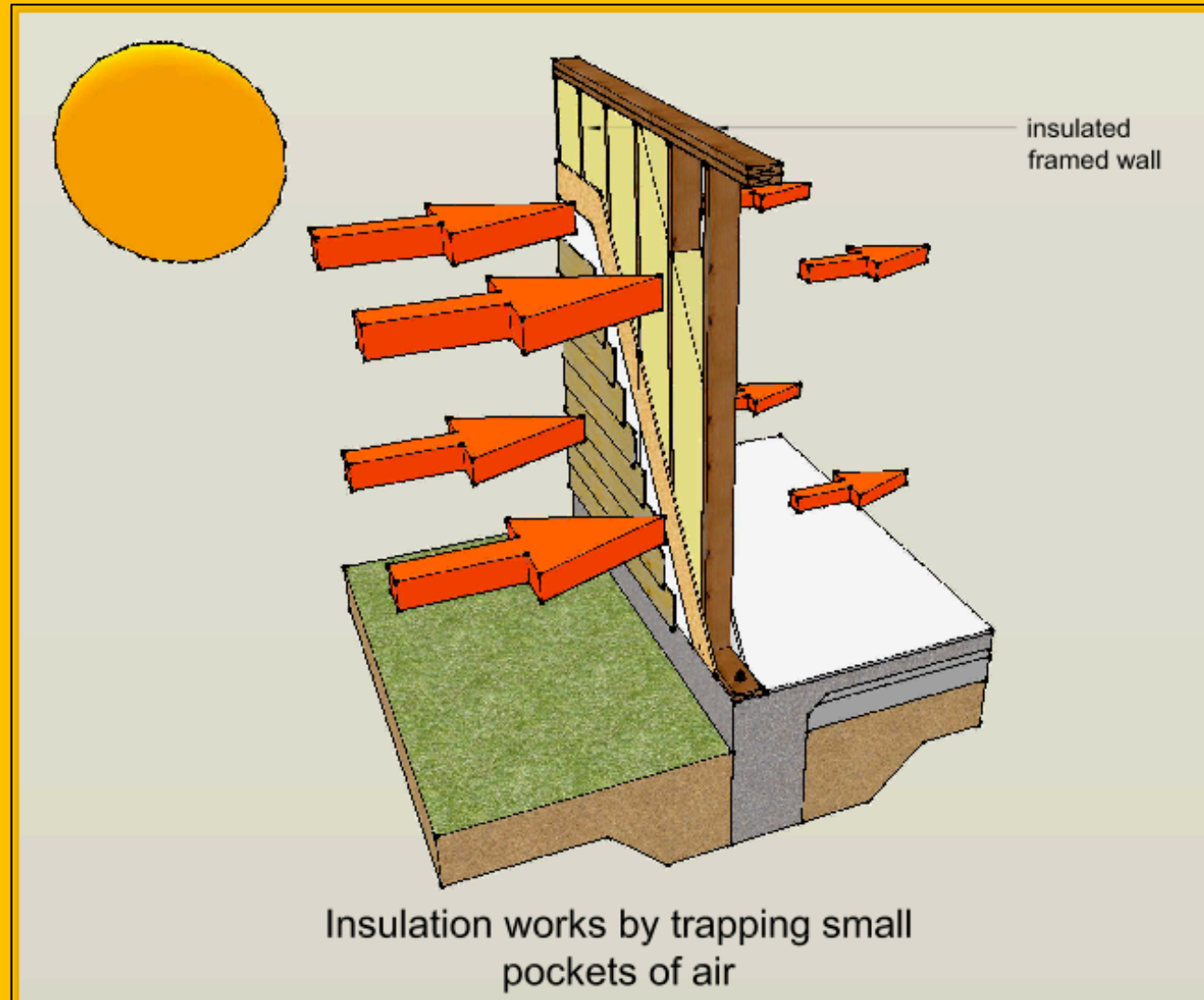

Image courtesy of Collette/Baker-Laporte

Insulation & Thermal Conductivity



Insulation & Thermal Conductivity



Insulation & Thermal Conductivity

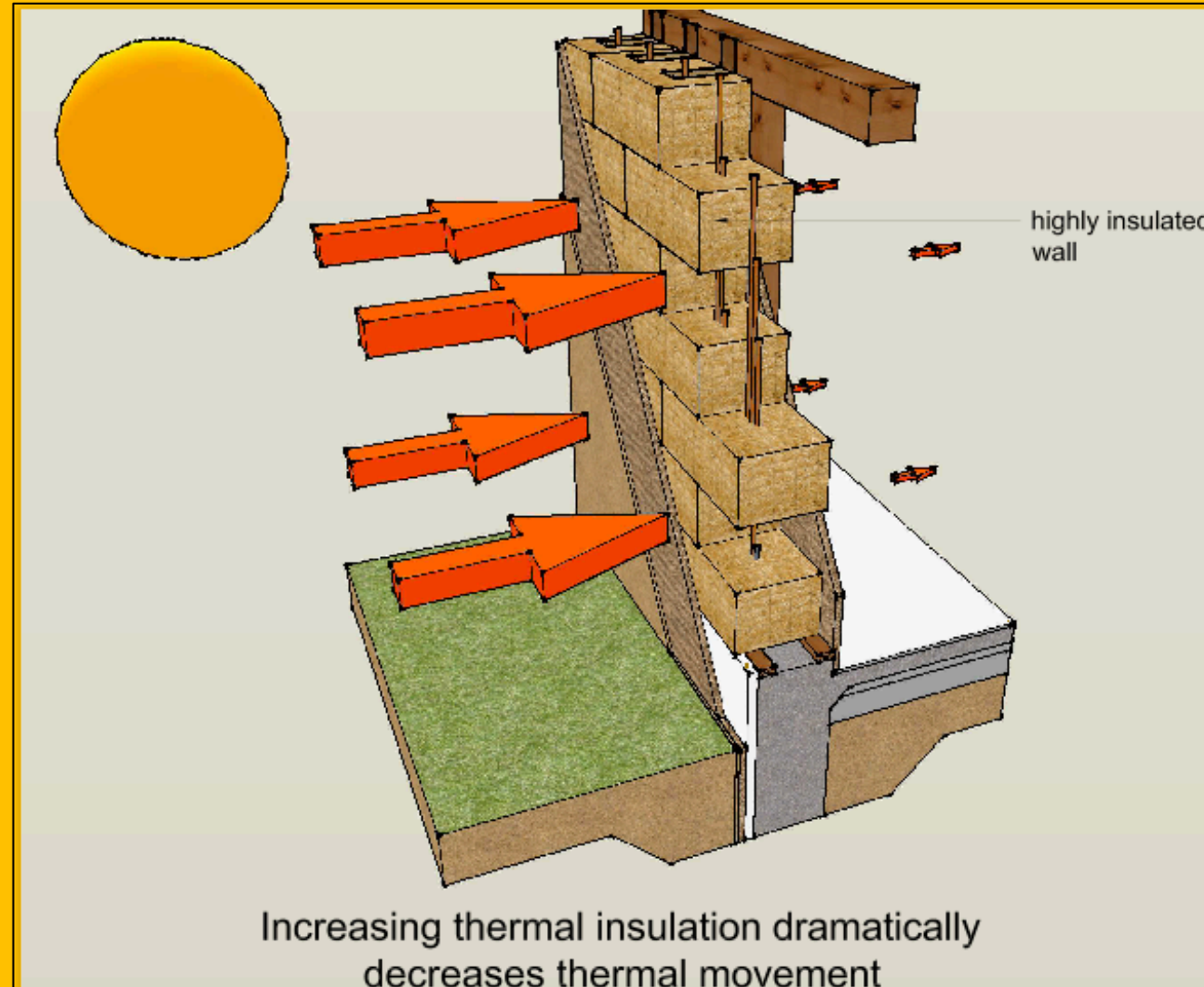



<https://www.hsapparel.ca/>

Instinct check:

It's February and you are going on a field trip to Toronto for **14 hours**:

Which of these is a better choice for outerwear?



<https://www.canadagoose.com/>

Insulation Types

- Insulation varies in its water resistance
- Can be quite permeable to air/vapour or act as an air barrier
- Batt types are air permeable
- Closed cell foams are air Impermeable
- SO... in roofs for instance
 - Batt types must be ventilated in roofs
 - Closed cell foams need not be ventilated

Environmental Issues

Insulation Material	R-value R/inch	Density lb/ft ³	Emb. E MJ/kg	Emb. Carbon kgCO ₂ /kg	Emb. Carbon kgCO ₂ /ft ² •R	Blowing Agent (GWP)	Bl. Agent kg/kg foam	Blowing Agent GWP/bd-ft	Lifetime GWP/ft ² •R
Cellulose (dense-pack)	3.7	3.0	2.1	0.106	0.0033	None	0	N/A	0.0033
Fiberglass batt	3.3	1.0	28	1.44	0.0165	None	0	N/A	0.0165
Rigid mineral wool	4.0	4.0	17	1.2	0.0455	None	0	N/A	0.0455
Polyisocyanurate	6.0	1.5	72	3.0	0.0284	Pentane (GWP=7)	0.05	0.02	0.0317
Spray polyurethane foam (SPF) – closed-cell (HFC-blown)	6.0	2.0	72	3.0	0.0379	HFC-245fa (GWP=1,030)	0.11	8.68	1.48
SPF – closed-cell (water-blown)	5.0	2.0	72	3.0	0.0455	Water (CO ₂) (GWP=1)	0	0	0.0455
SPF – open-cell (water-blown)	3.7	0.5	72	3.0	0.0154	Water (CO ₂) (GWP=1)	0	0	0.0154
Expanded polystyrene (EPS)	3.9	1.0	89	2.5	0.0307	Pentane (GWP=7)	0.06	0.02	0.036
Extruded polystyrene (XPS)	5.0	2.0	89	2.5	0.0379	HFC-134a ¹ (GWP=1,430)	0.08	8.67	1.77

1. XPS manufacturers have not divulged their post-HCFC blowing agent, and MSDS data have not been updated. The blowing agent is assumed here to be HFC-134a.

R-Value Comparison

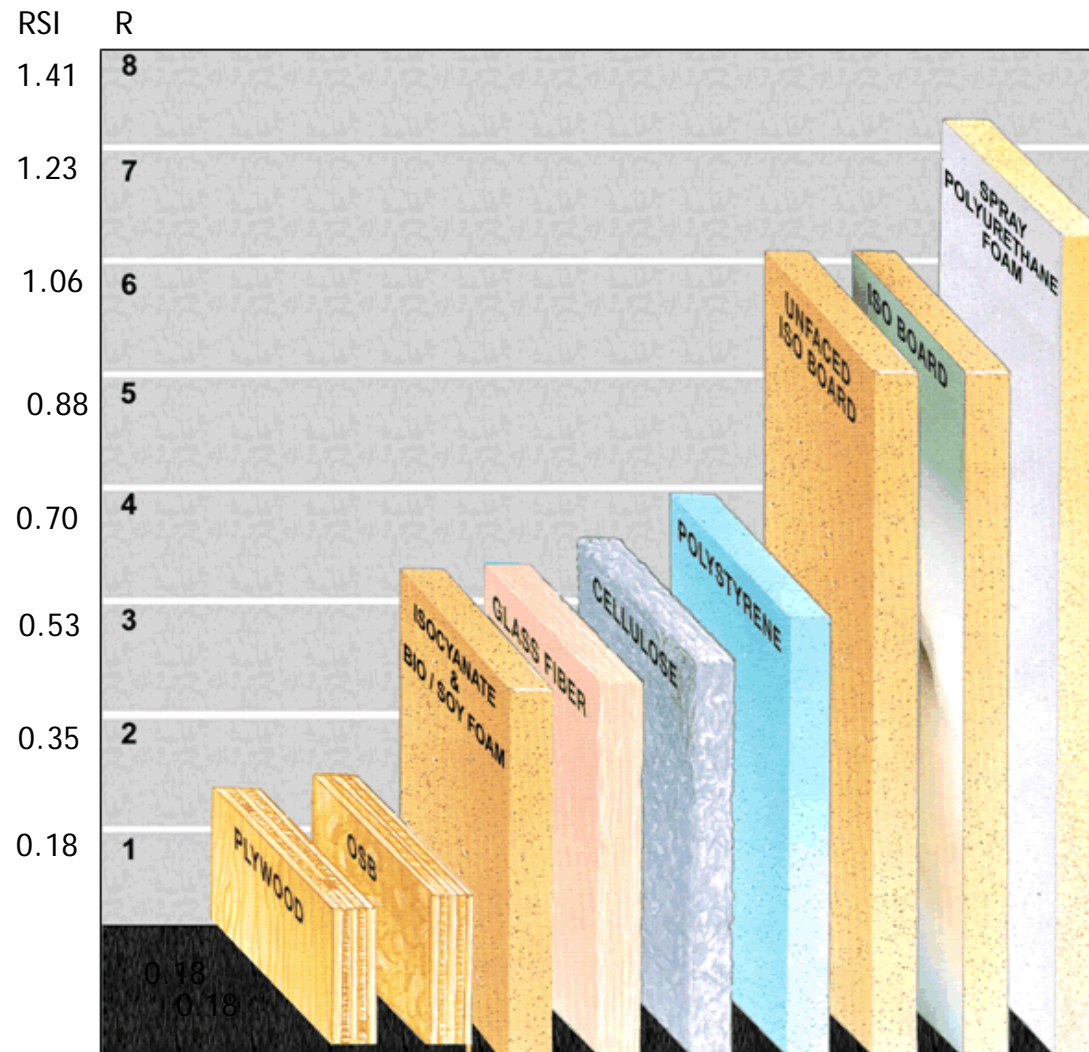

R/RSI value per inch/25mm of various insulating materials

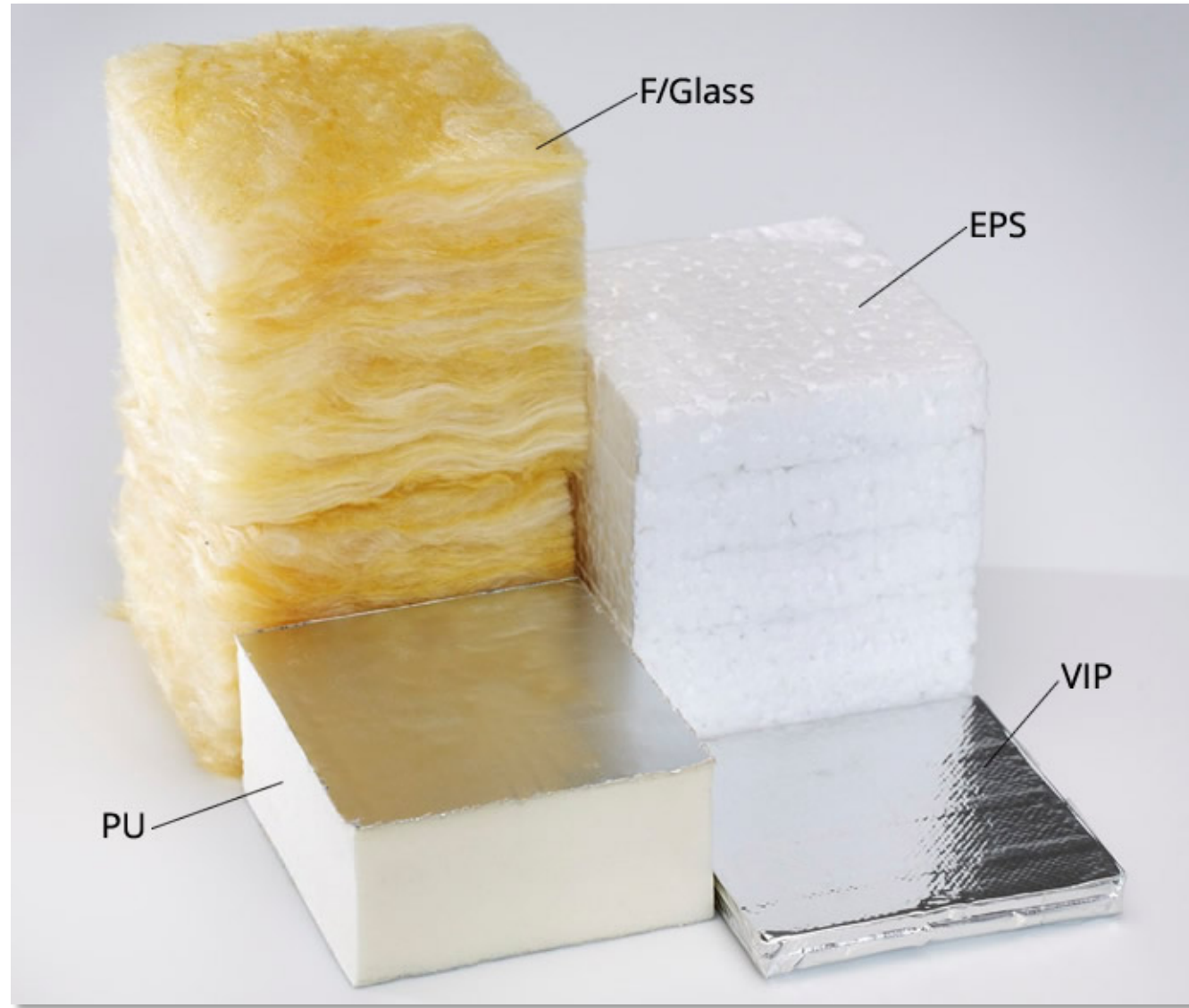

How Much Insulation?

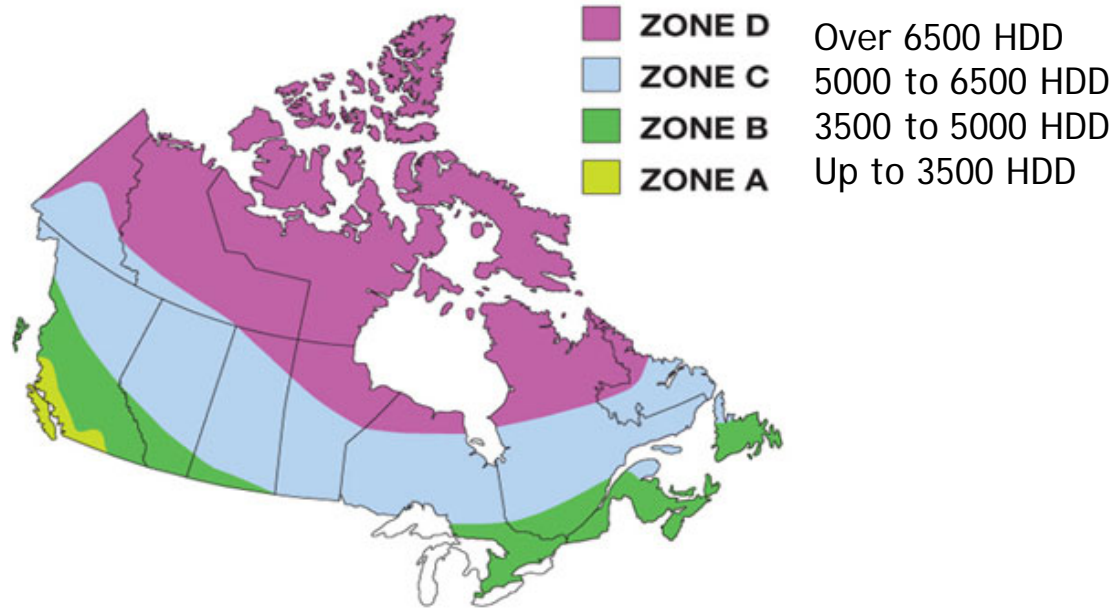

More insulation is required in ceilings as hot air rises so there is more thermal loss in that direction.

ZONE		A	B	C	D
Walls	RSI	3.0	3.6	4.1	5.3
	R	17.0	20.0	23.0	30.0
Basement walls	RSI	3.0	3.0	3.0	3.0
	R	17.0	17.0	17.0	17.0
Roof or ceiling	RSI	4.5	5.6	6.7	9.0
	R	26.0	32.0	38.0	51.0
Floor (over unheated spaces)	RSI	4.7	4.7	6.7	9.0
	R	27.0	27.0	38.0	51.0

Courtesy Producer Member Thermo-Cell

<https://isolofoam.com/en/r-rsi-converter/>
 Divide number by 25 to convert to RSI/mm

Batt Type Insulation

- Typical for Pitched Residential roof applications and exterior walls.
- Most often laid on the ceiling of the attic leaving lots of ventilation space above



Should be wearing a mask!
The glass fibres are cancer causing.



Can be installed in roll form or blown in loose (loose often for retrofit as easier)



Batt/loose Type Materials



Cellulose

- **Recycled Content:** 80% to 100%
- **Method and form:** Cellulose consists of shredded newsprint and is non-toxic, recycled and generally local. It's great for attics, you can blow it to whatever depth you want (with proper ventilation) and there are no seams to allow heat loss. It's also an excellent choice packed into walls because it allows little air infiltration and it's fire and insect resistant.
- **R value:** 3.66 per inch RSI = 0.026/mm
- **Notes:** All around this is the best choice for performance and environmental impact, but not recommended for basements due to its sensitivity to moisture.



Cellulose

Considered to be the most environmentally benign.



Fiberglass

- **Recycled Content:** About 20%
- **Method and form:** Batts are most common but it's available in rigid. Reasonably low impact in production; raw materials are abundant; it offers good R value and reasonably good soundproofing.
- **R value:** 2.9 - 3.8 per inch; RSI: 0.020 - 0.027/mm
- **Notes:** Fibres are volatile and installation can irritate the skin. Be sure to wear a mask, gloves and goggles. Make sure it is well installed- It doesn't perform well if compressed, and gaps around studs and headers can actually encourage **air convection causing heat loss**.
- Fibreglass is moisture sensitive and should not be installed where it will be exposed to moisture. Despite how commonly it can be found insulating foundation walls, it should never be installed against a cold concrete wall.

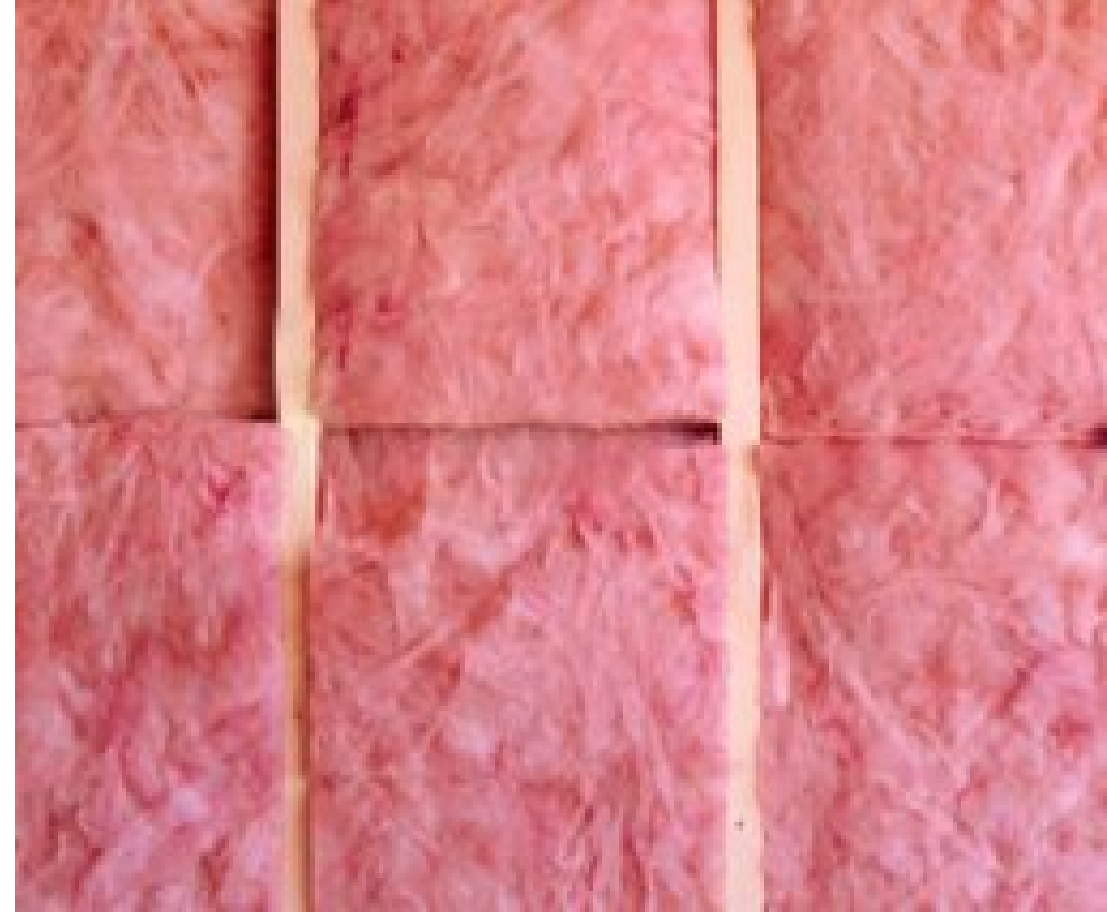



Fibreglass batt wall insulation is typically friction fit between the studs.

Stone/rock/mineral Wool

- **Recycled Content:** there is a minimum of 75% industrial waste in stone wool insulation, often as high as 90%.
- **Method and form:** Batts or rigid panels, the batts are an excellent replacement for fiberglass. Stone wool can be more costly per batt but has a higher R value than fiberglass per inch; less health risks during installation; easier installation; it performs better for fire and sound and is less harmful to the environment.
- Stone wool in interior walls reduces sound between rooms and floors, as well as offering fire protection.
- **Below grade durability :** as the climate warms, termites are moving north into Canada. Termites love foam insulation but the fibers in stone wool cut them, so they leave it alone.
- **R value:** 4 per inch; RSI = 0.028/mm







Insulation placed in the cavity of commercial buildings is more dense than the residential type that is friction fit between the wall studs.

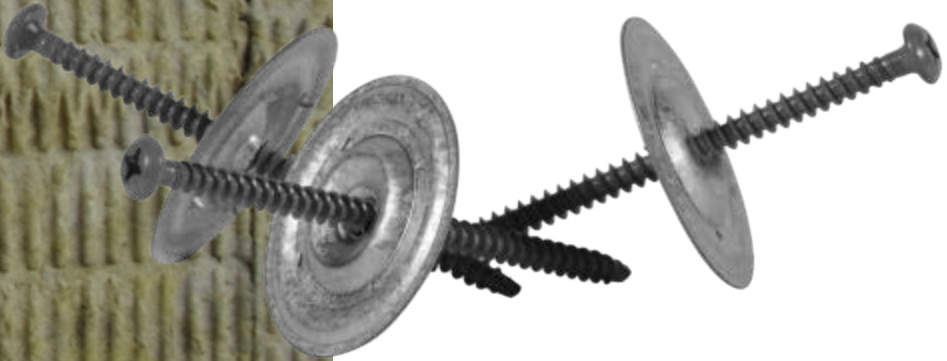



When dense mineral wool is placed on a flat roof it must be in a **protected position** so that it doesn't get wet.



Roofing membrane is being installed over the dense/rigid mineral wood insulation to protect it from moisture.

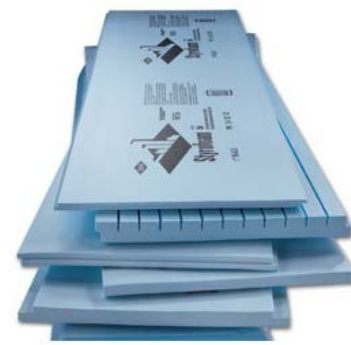

Polystyrene: Expanded (EPS) vs. Extruded (XPS)

- XPS (Extruded polystyrene) refers to the coloured solid foam panels you most often see on the outside of buildings under construction. It offers a higher density and higher R-value per inch than EPS (expanded polystyrene) but because of its lower cost, EPS offers more R-value per dollar spent.
- Manufacturers of XPS and EPS claim both products can be recycled, but a complete life cycle analysis shows EPS having a better overall environmental impact when compared to XPS, as EPS can be recycled in many more ways at the end of its usefulness.

Extruded Polystyrene Foam (XPS)

- Recycled content: Minimal at best.
- Method and form: Comes in panels, 2x8, 4x8 and other dimensions.
- R value: 5 per inch; RSI= 0.035/mm
- Notes: XPS acts as a vapour barrier and air barrier.
- Blowing agents are 1430 times worse than carbon dioxide, exponentially worse than EPS. For ecological reasons rather than performance, we recommend limiting its use when possible. A combination of polyethylene and EPS can offer the same vapour protection as XPS, more affordably and with significantly less impact on climate.
- XPS is durable and unharmed by moisture, so it works well below grade.



It's blue or pink, depends on the manufacturer.



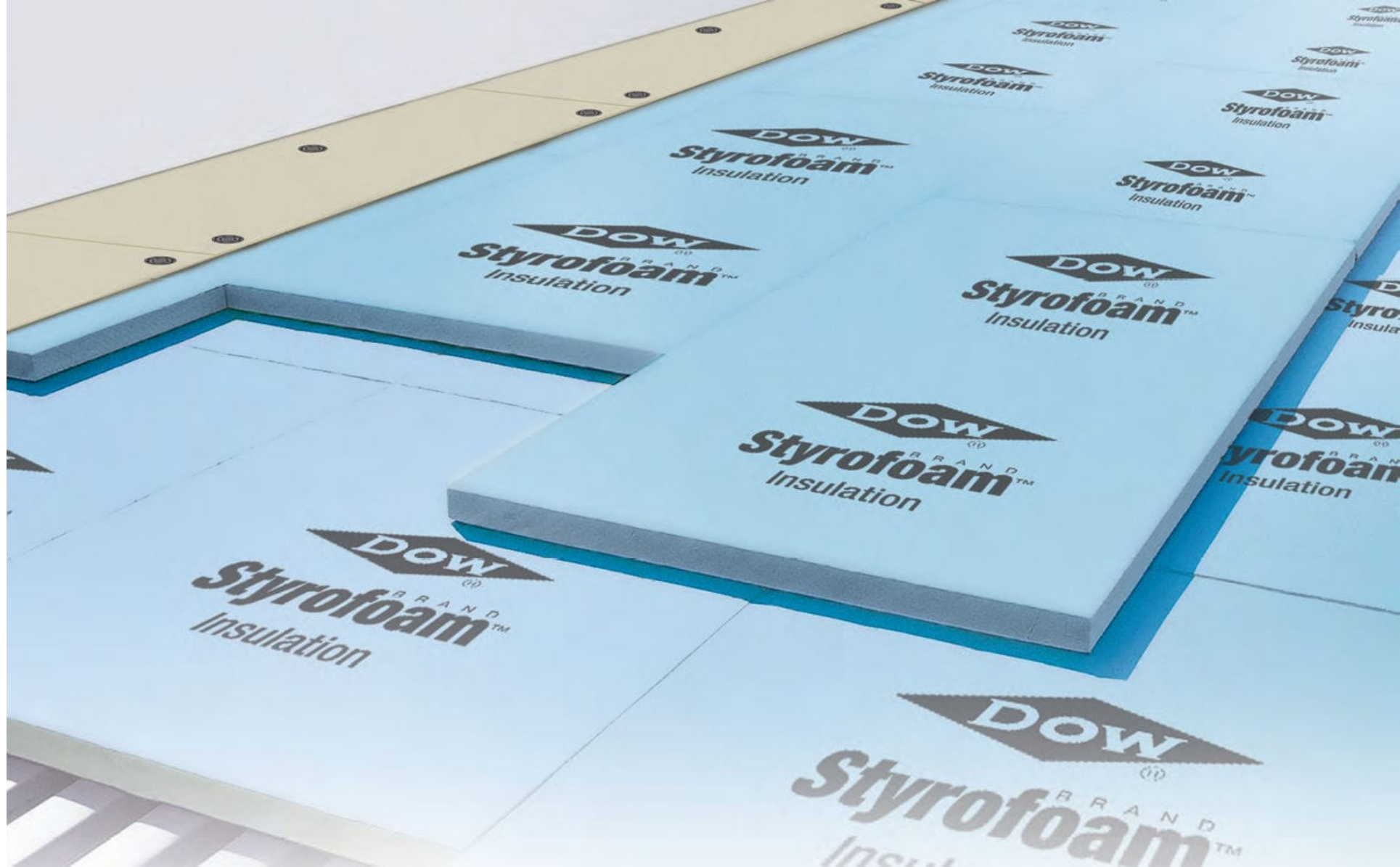

XPS, though waterproof, is placed below the membrane here to protect it from UV radiation.



When XPS is placed above the membrane it must be ballasted to protect it from wind uplift.

Here you see a drainage board covered by a filter cloth to keep the ballast from creeping down to damage the roofing membrane.

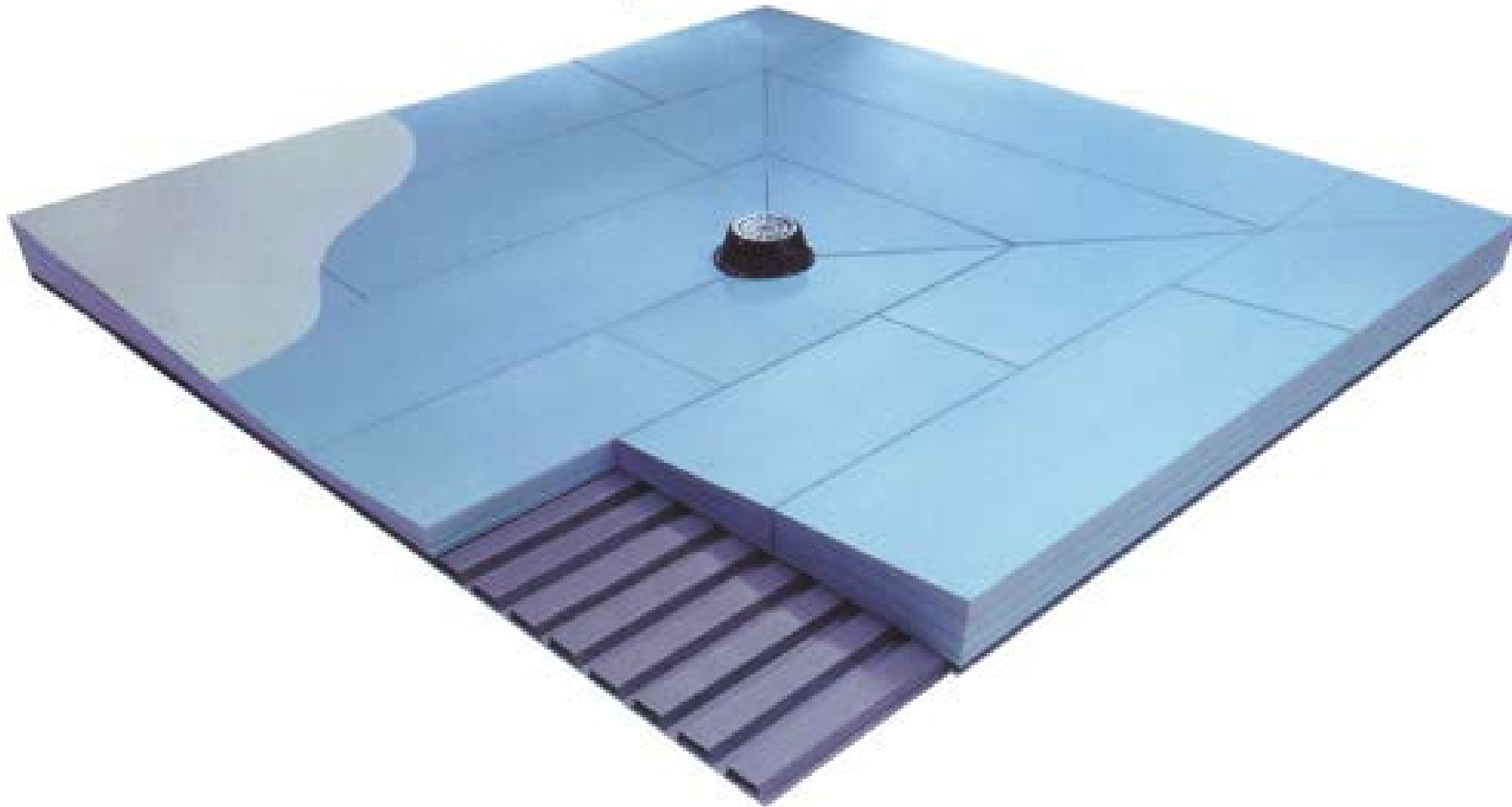

XPS insulation comes in tapered boards for use on roofs to support drainage where a sloped structural deck is not desired.

Expanded Polystyrene Foam (EPS)

- Recycled content: Not very high.
- Method and form: Comes in panels, 2x8, 4x8 and other dimensions, with variable thicknesses.
- R value: 3.6 to 4.2 per inch; RSI= 0.025 - 0.030/mm
- Notes: EPS is the only commercially available foam insulation panel that is at all vapour permeable, which can be an advantage in some applications, as can those that are vapour impermeable.
- The common blowing agent for EPS is pentane gas, which is ozone safe but has a global warming potential (GWP) 7 times greater than carbon dioxide. This is significantly lower than other types of foam, so we recommend it as the preferred choice of foam whenever possible.
- Excellent for below grade applications, both inside and out. EPS is unharmed by moisture, and allows a certain amount of moisture to pass through it.





EPS comes in varying thicknesses and also in tapered slabs to assist in roof drainage.

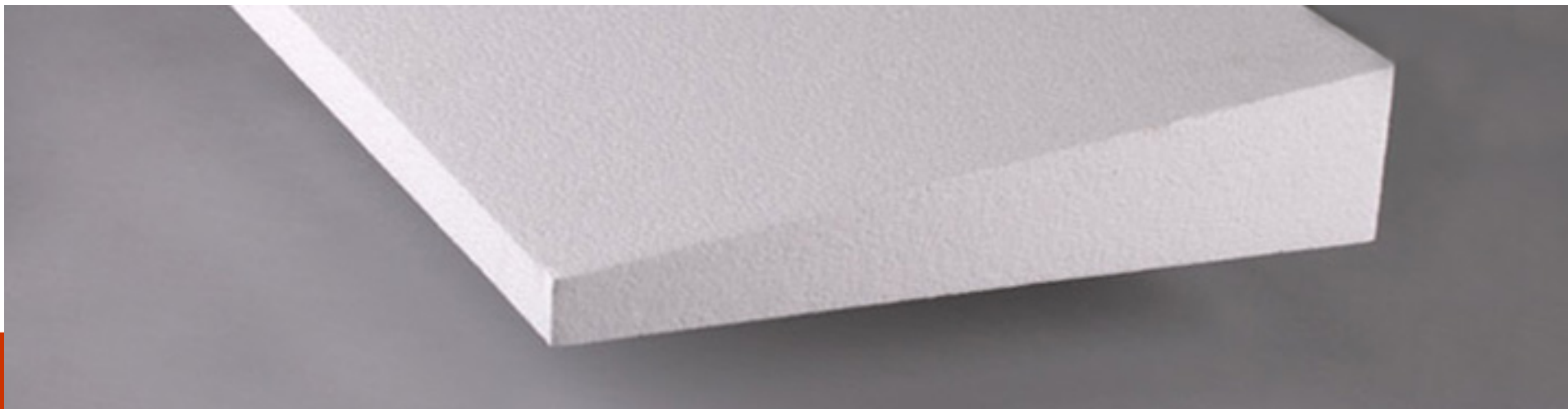



EPS foam used on a roof, installed under the roofing membrane in a protected position.

Tapered slabs are used to create the slope to drain the roof, leaving the roof itself, flat.



Benchmark Foam ICF insulated concrete forms build on bond



Some insulated concrete forms are fabricated from EPS material.

SPUF (Spray Polyurethane Foam)

- **Recycled Content:** Minimal at best. Some are advertised as 'soy based' but there is so little soy content compared to the ecological impacts, that it borders on green washing. Use it for its excellent properties, but don't fool yourself into thinking your home is insulated with tofu, because it most definitely is not.
- **Method and form:** Urethane is sprayed on, and structurally solid to the point that you can walk on it in about 20 minutes.
- **R value:** 6 per inch; RSI = 0.042/mm
- **Notes:** SPUF acts as a vapour barrier and air barrier; blowing agents are also much worse than carbon dioxide and EPS. Off-gassing can be an even greater concern than other products as chemicals are mixed onsite, so no off-gassing takes place in manufacturing facilities and different stages of transit, but rather all in your home.



SPUF also functions as an air barrier. It is quite good at sealing up joints.





Polyurethane foam insulation - which also acts as an air barrier - is termed a "closed cell" insulation. i.e. it will not absorb moisture.

They need to trim the excess before installing the drywall.

More than just food!



Soy beans are being used to make more environmentally friendly spray foam insulation that also acts as an air barrier!





This type of application is particularly useful in attics as you do not have to provide a vent space!



Polyisocyanurate

- Method and form: commonly in 2x8 or 4x8 sheets
- Performance: R6 - 6.5 and even higher are the claims of some producers but , independent researchers say it is more accurately calculated at about R5.6 per inch.
- Polyiso is moisture sensitive, so it is important that it not be exposed to weather during construction or its service life. Panels come with foil membranes on either side to contain gas, though it will leak out eventually, reducing R values.
- The stated performance is R6 - 6.5 per inch, but this is somewhat misleading as that is only at warmer temperatures. The performance starts to drop significantly below 10° C, and its performance at much lower temperatures (-20° C and below) is abysmal, hardly better than wood.
- Be aware that the foil membrane acts as a vapour barrier, and taped can act as an air barrier as well.



www.finehomebuilding.com

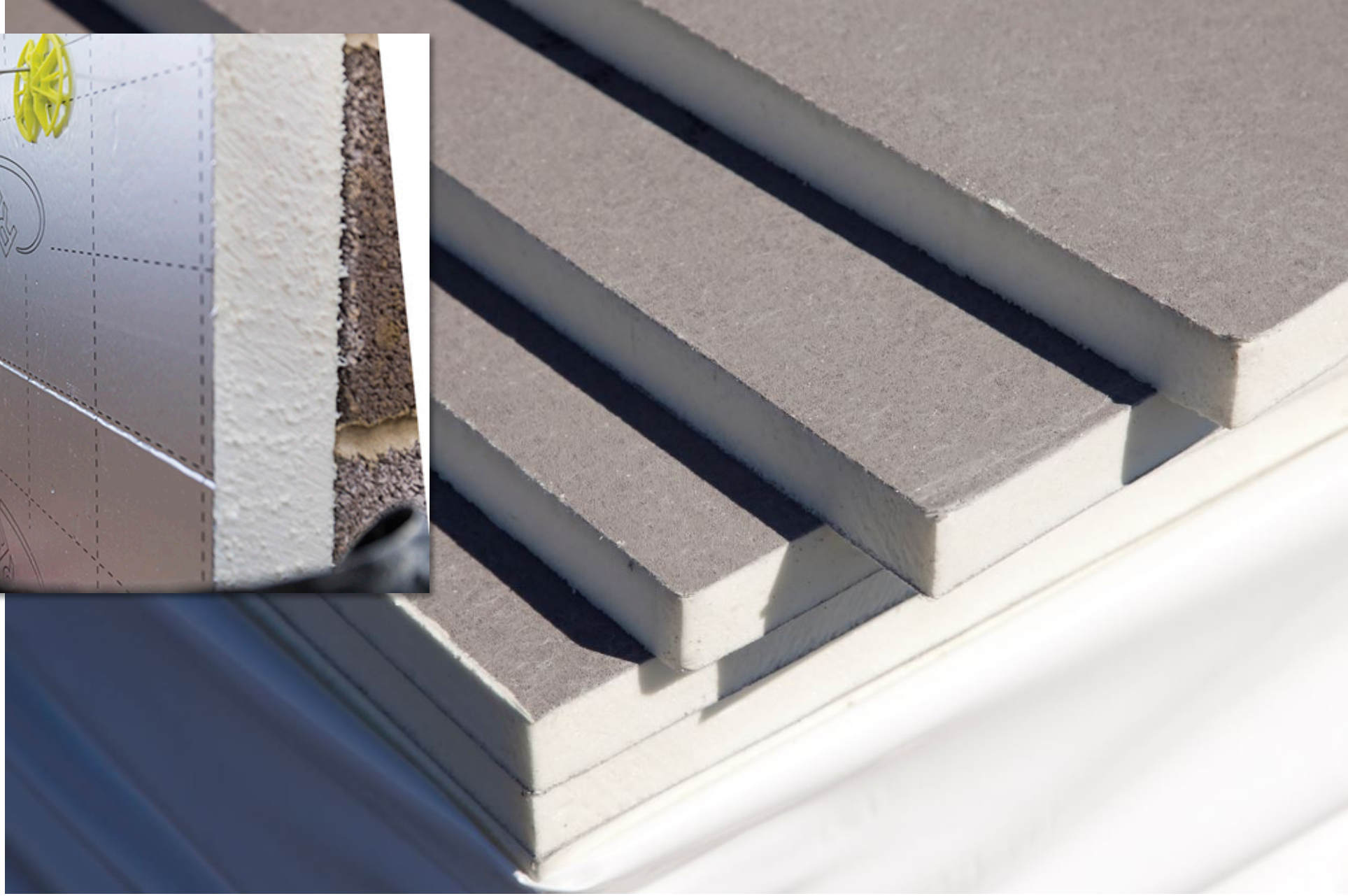

Cotton Insulation (recycled denim)

- **Recycled Content:** 90-100% recycled.
- **Method and form:** It comes in batt form like fiberglass and stone wool. It performs better than fiberglass during high winds and at low temperatures; it is extremely effective for sound absorption and thermal performance; easier installation than fiberglass; no protective gear needed; it contains 10% boron-based fire retardant (a natural non-toxic mineral), and it's resistant to fungus, mold, and pests.
- **R value:** 3.4-3.7 per inch; RSI= 0.024 - 0.026/mm
- **Notes:** It takes less energy to manufacture than other types of traditional insulation, contains no chemical irritants, and is completely safe and easy to install by homeowners. It's not too common in the Canadian market yet, so it might be expensive if your lucky enough to even find it.



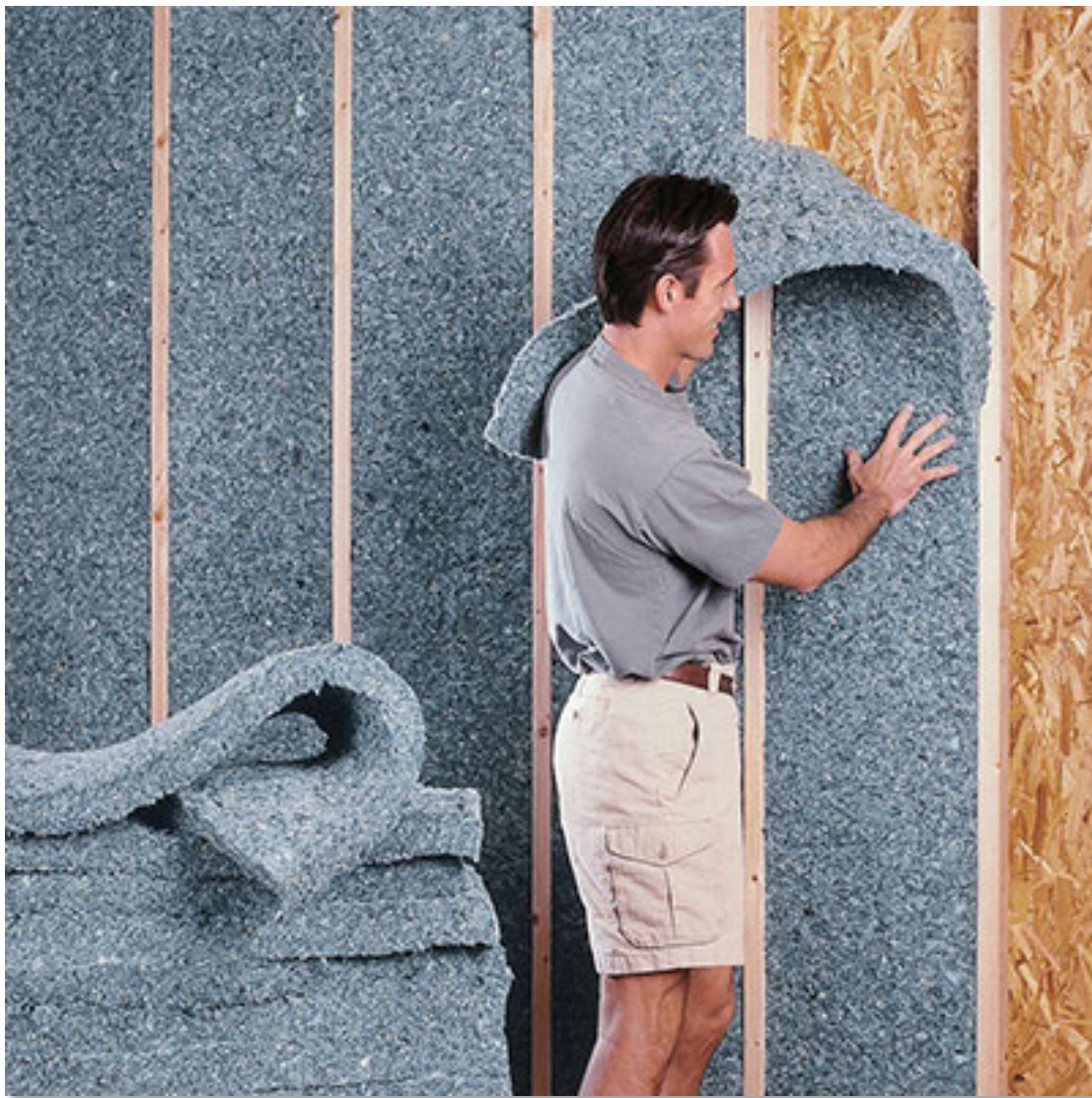



UltraTouch
Denim Insulation
R30
Length = 48 in
Width = 36 in
Thickness = 3.6 in
Coverage per Roll = 12.96 sq ft

UltraTouch
Denim Insulation
Engineered for Wood Framing
R30
No fiberglass itch
Sound Absorption
80% Recycled Content
Energy Saving Thermal Performance

UltraTouch
Denim Insulation
Engineered for
R30
No fiberglass itch
Sound Absorption
80% Recycled Content
Energy Saving Thermal Performance



Air Barriers vs Vapour Barriers



It is the job of the building envelope to keep what is in, in, and what is out, out.

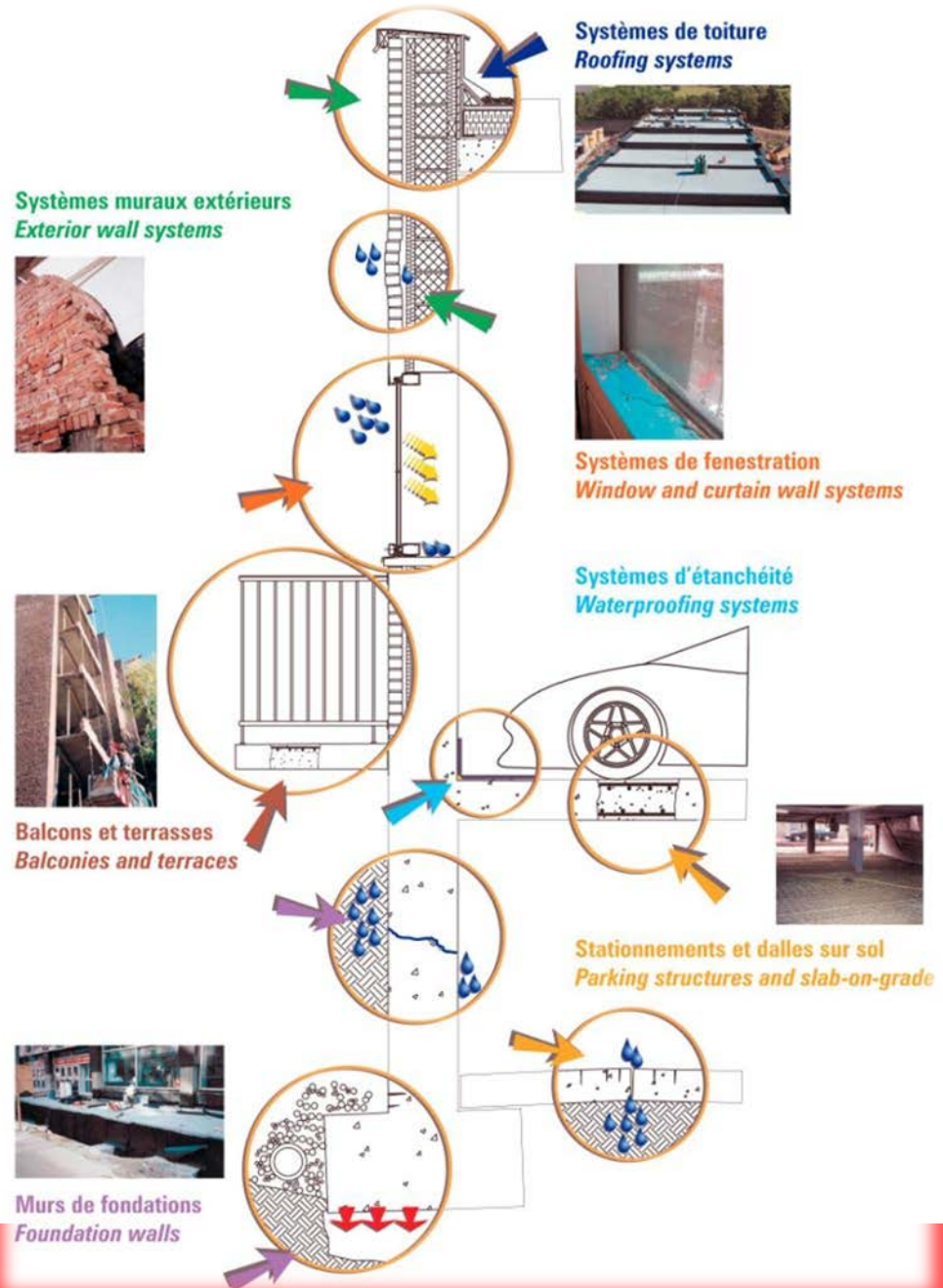

Keeping the outside, out... and the inside, in...

Many building performance problems can be traced to air leakage through the building envelope. These problems range from high heating costs and poor temperature control in occupied spaces to rain penetration and the deterioration of brick on exterior walls.



Figure 1: View of severely corroded hot-dip galvanized structural members due to poulitice corrosion from wet building sheathing. Metal loss exceeded 20% of original thickness.

exfiltration

When moisture inside the building escapes through defects in the building envelope, it condenses, freezes and causes damage inside of the wall.

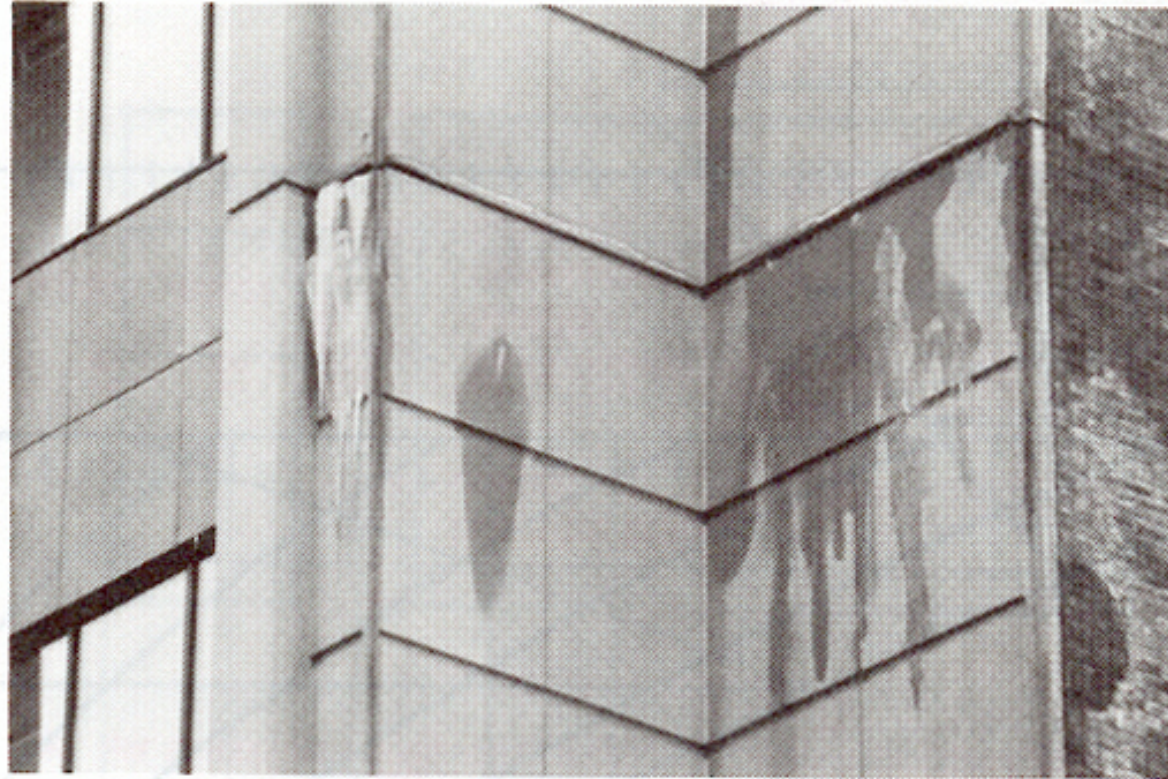

Figure 2.10 Exfiltration/Condensation

Air leakage on a masonry building



Fig. 15 Example of air leakage on the side of a building

Efflorescence, also a sign of air leakage



Fig. 16 An example of extensive wetness and efflorescence

UW Coop Services Building



Look closer...





And closer.
What is wrong?
Why?







**COLLECTION
OF ICE
AND WATER
IN COLUMN
CAVITIES**

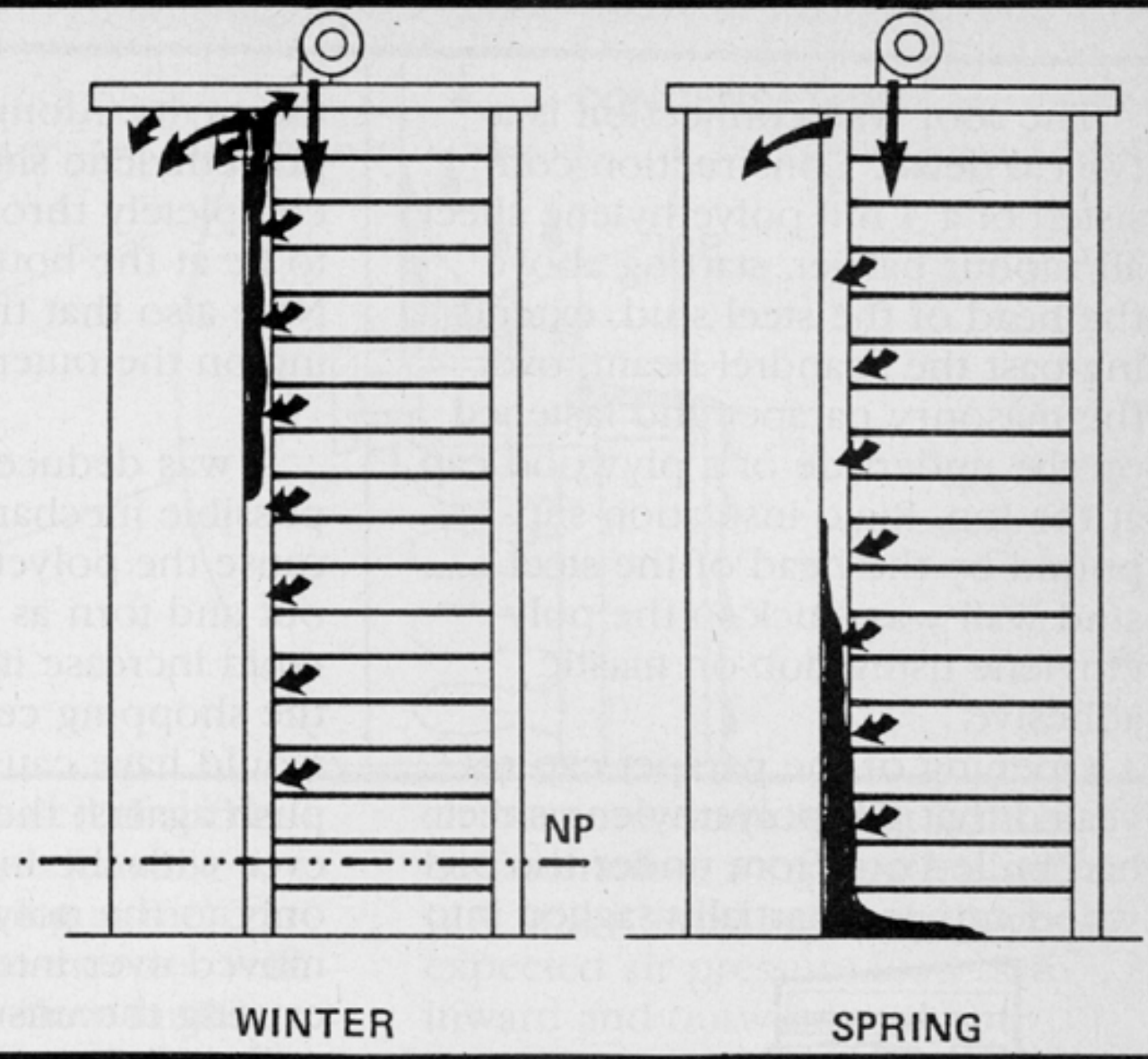

WINTER

SPRING

Why does moisture move from inside to outside?

Moisture exists and hence can be moved in two forms. Most air has a certain moisture content referred to as relative humidity. Humans need a certain amount of humidity in heated indoor air to maintain a healthy environment (otherwise we get nosebleeds, etc.) So moisture exists as microscopic parts of the air itself. This moisture can be moved RIGHT THROUGH THE BUILDING ENVELOPE (like ghosts move through solids...), as well as THROUGH CRACKS IN THE BUILDING ENVELOPE.

Air pressure differential is the key force that drives both air leakage and vapour diffusion through the building envelope.



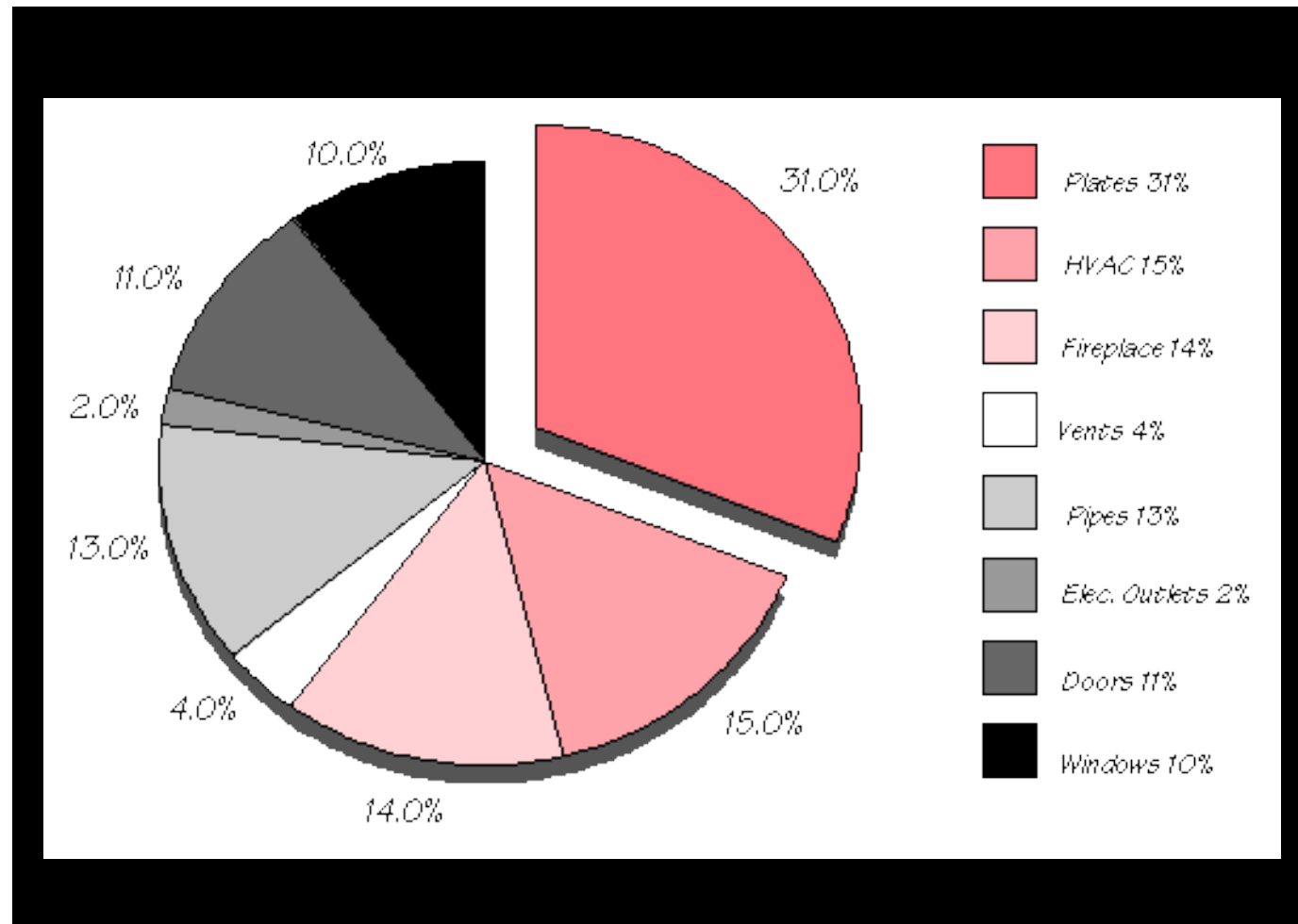

The Air Leakage Pie...

What drives pressure differential?

The air pressure differential is driven by, or relies on several key factors. If there is no pressure difference between the interior and exterior, there will not be air or vapour movement across the building envelope.

- **temperature differential** (hot inside, cold outside)
- **stack effect** (warm air rises)
- **wind pressure** (windward pressure, leeward suction)
- **fan pressurization** (kitchen, bathroom and furnace fans)



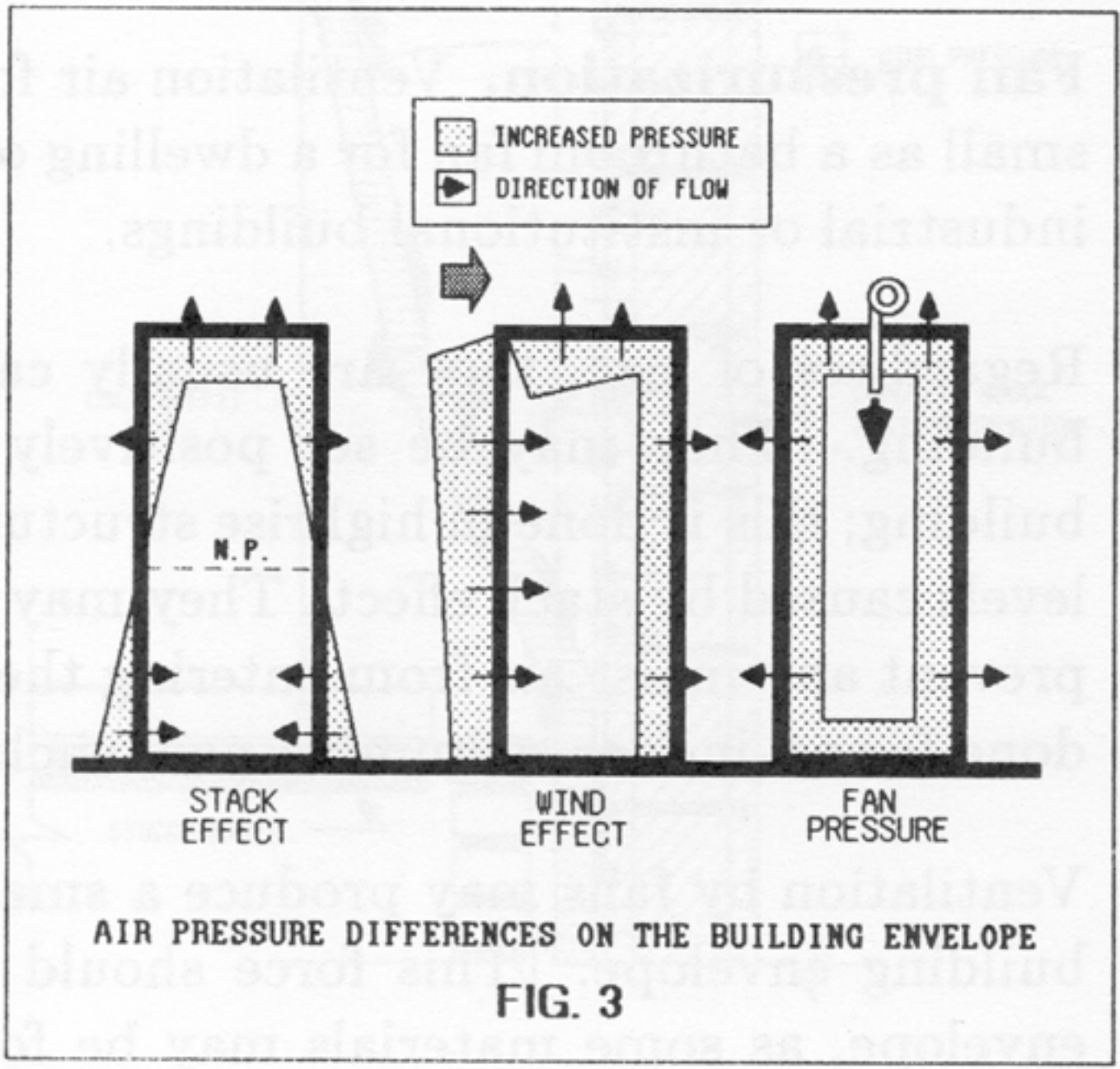

Stack effect

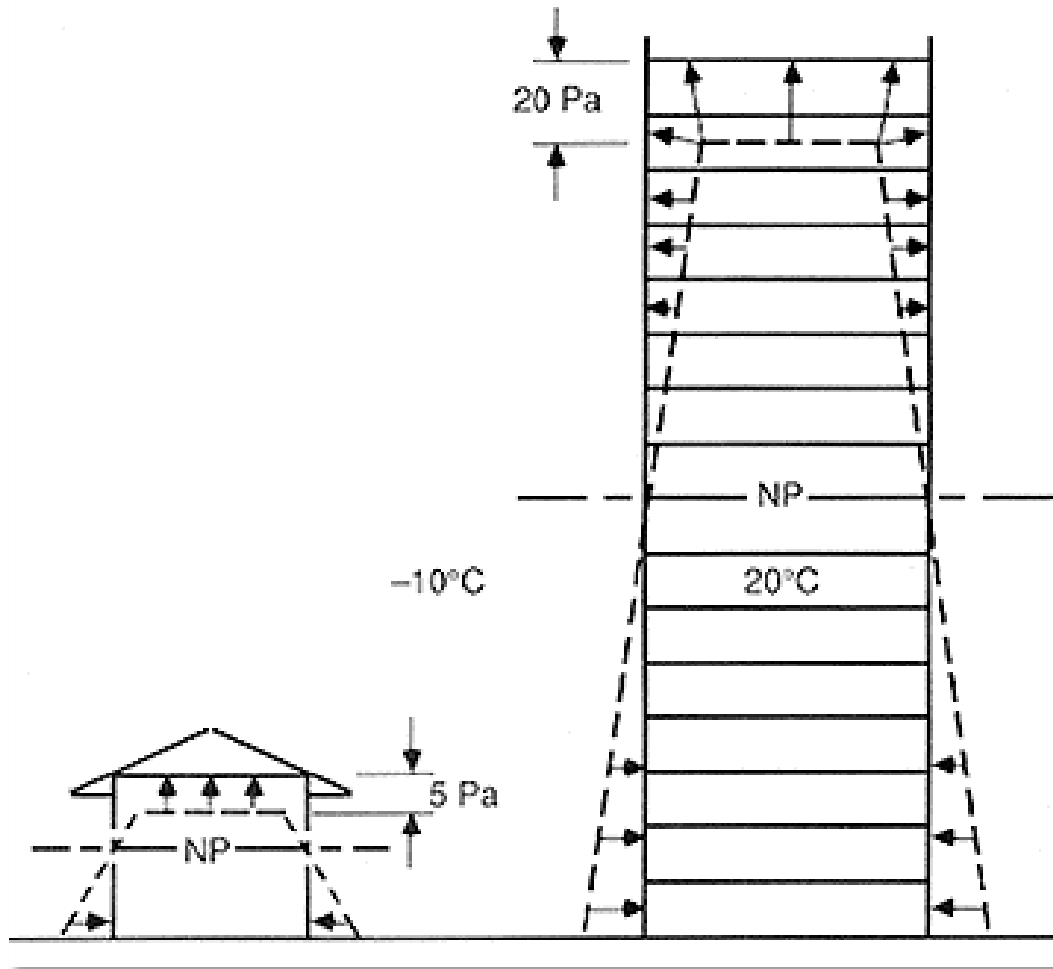

Stack effect is a bigger problem the higher the building. Look at high rises with "problems". Usually evidenced at the top floors of the building first as there is more driven warm moist air trying to escape through the upper part of walls.

Fan pressurization

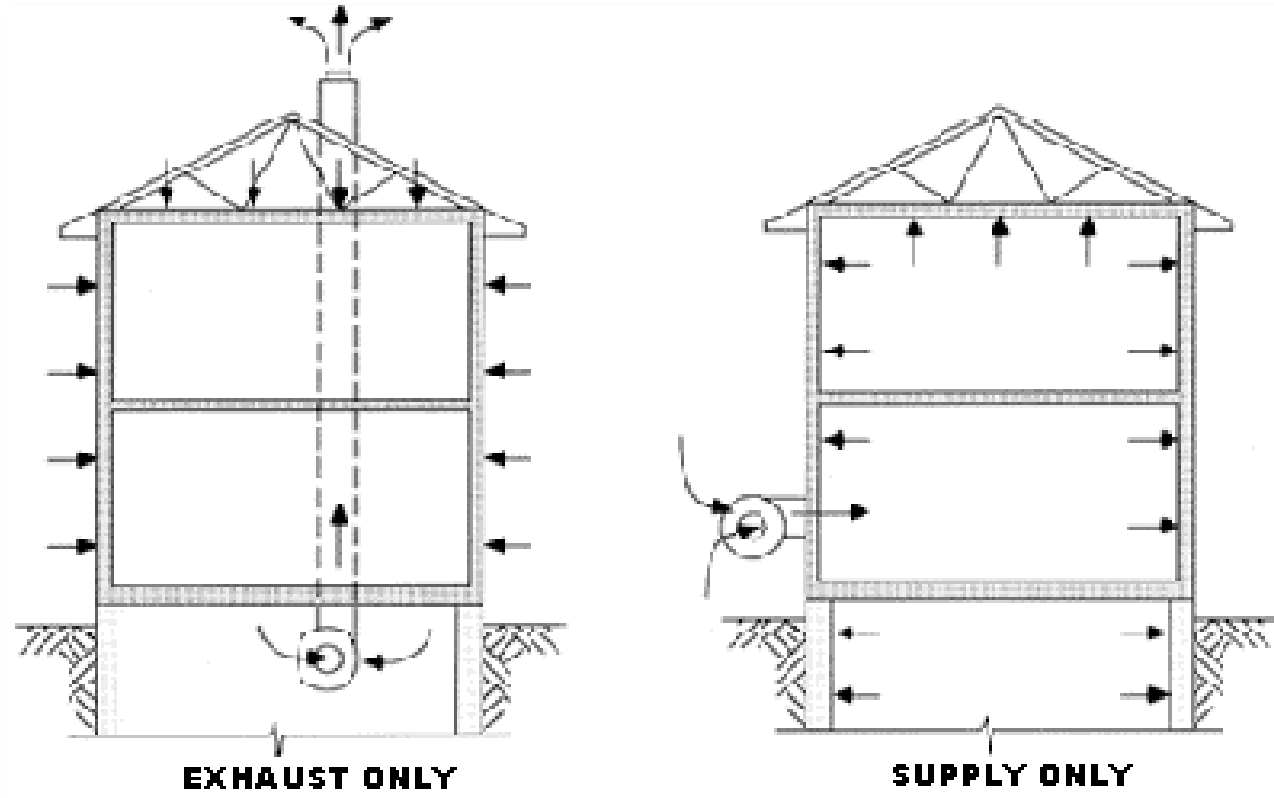

Depending on the direction of air movement from the fan, a house can either be pressurized or suck air in from outside.

Temperature differential

The larger the temperature difference, the more drive across a wall. Hence worse in the cold winter. Temperature drives air and vapour leakage as well as basic heat loss through the building envelope.

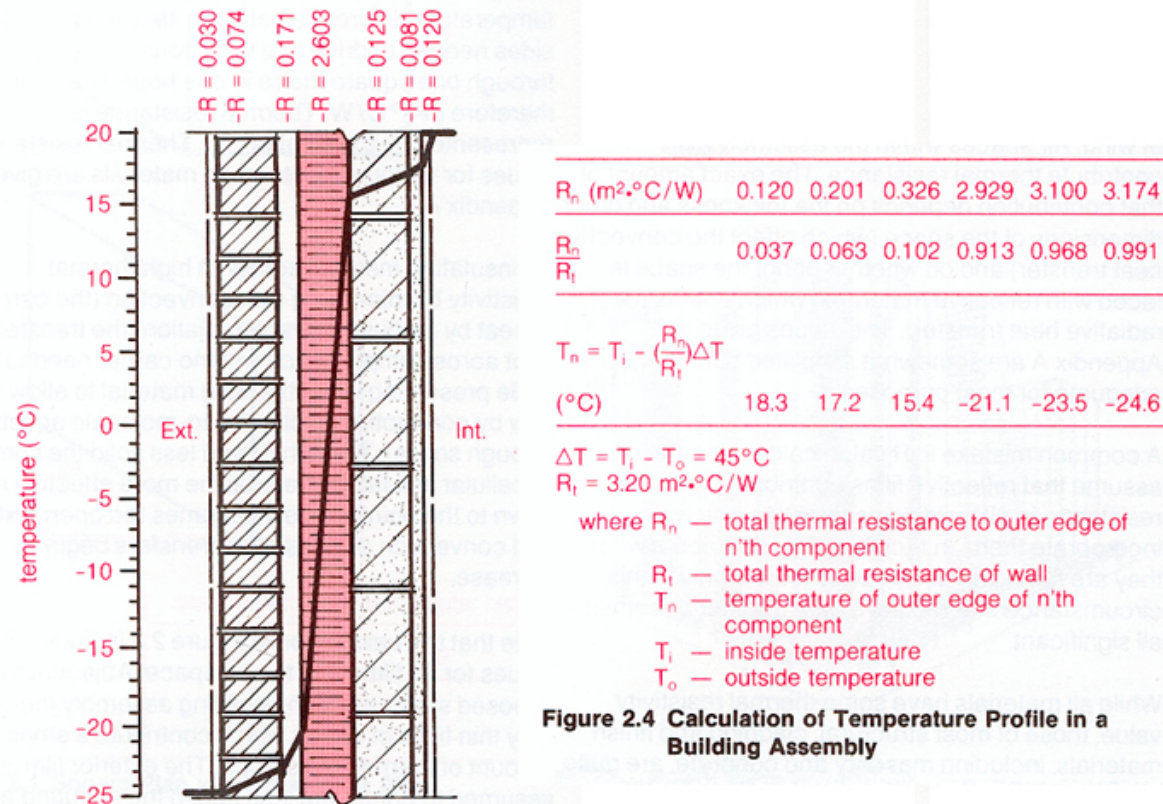

wind

Depending on the wind direction, a high or low pressure area is created, pushing or pulling moisture through the building envelope.

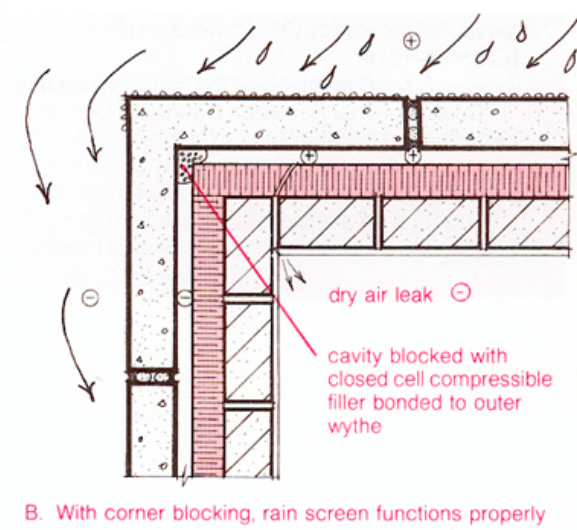
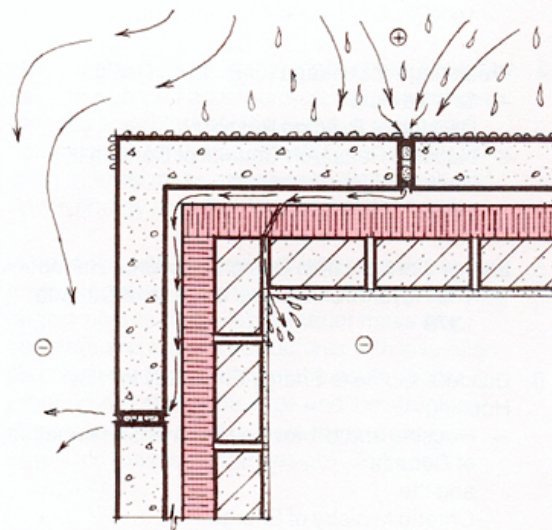
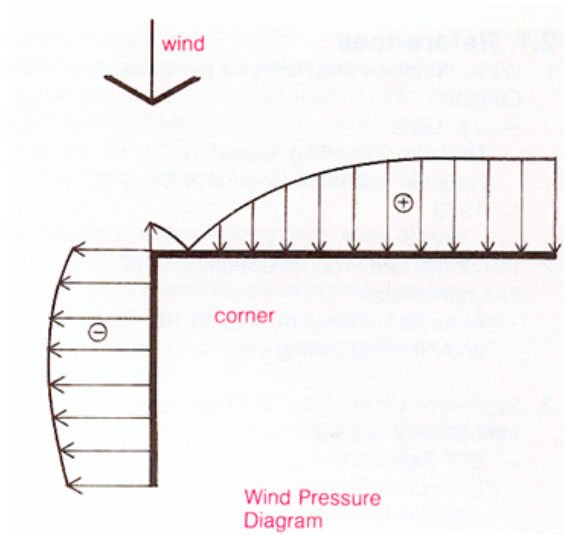
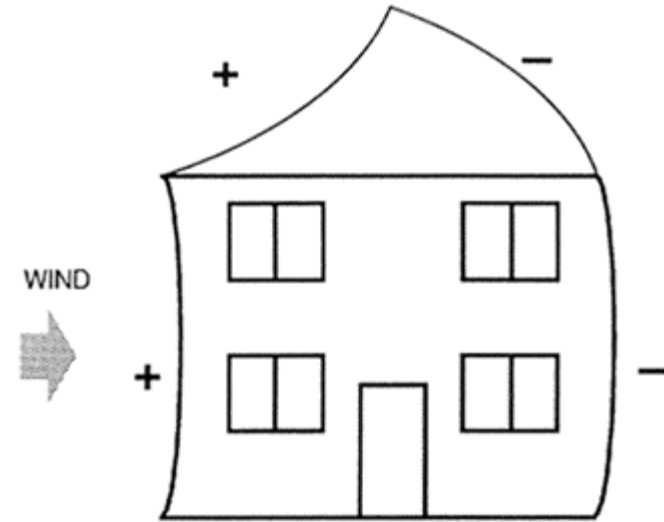

A. Corner conditions defeat rainscreen

B. With corner blocking, rain screen functions properly

Figure 2.22 Dealing with Wind-Driven Rain at Corners.

Moisture moves through the envelope in 3 ways....

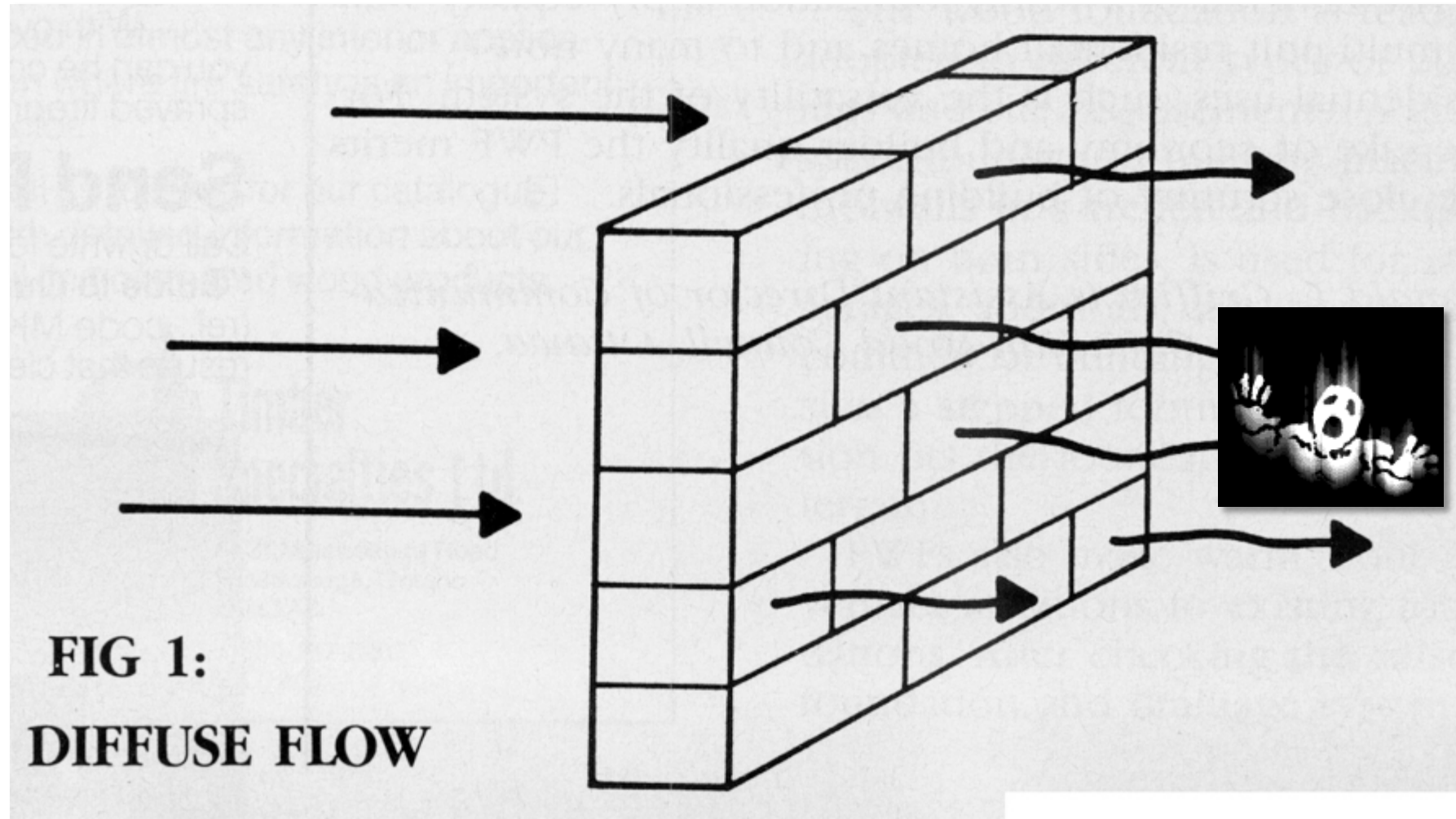

And by channel flow...

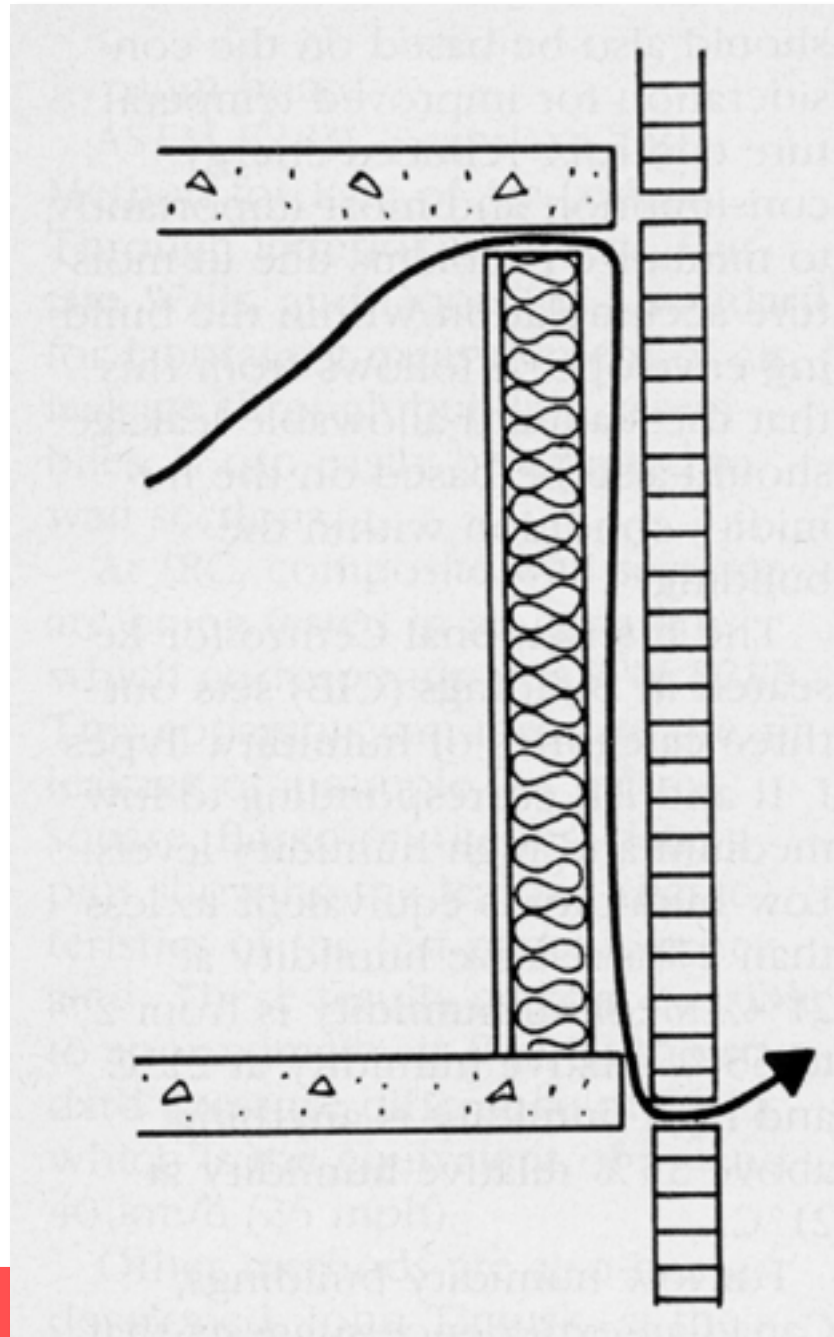

And through
orifice flow...

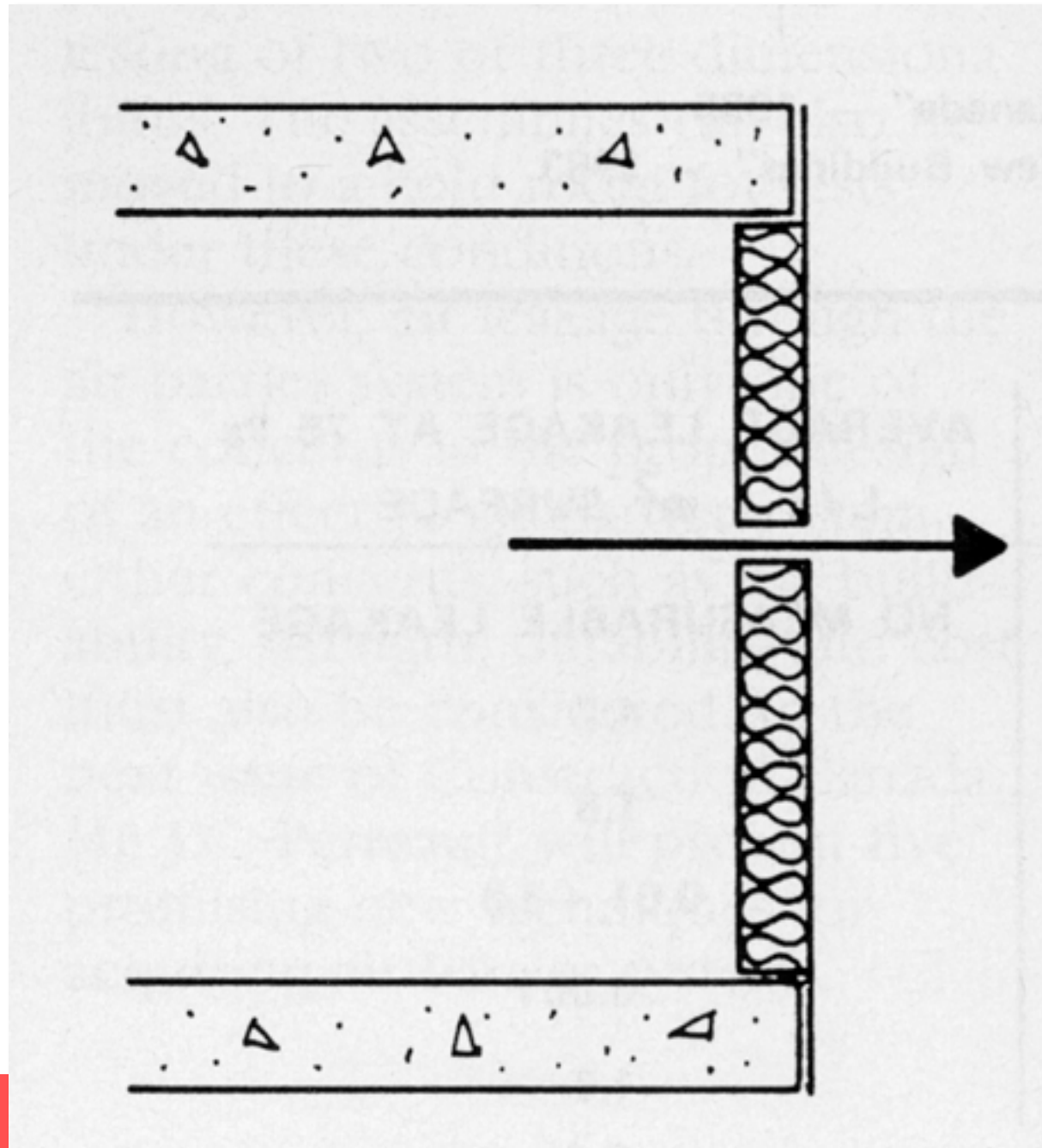

The vapour barrier

For many years, designers were taught that the **vapour barrier** was a major requirement for insulated walls in order to control the diffusion of water vapour into the colder reaches of these walls, where it could condense and stain the finished surfaces or, worse, initiate the deterioration of the affected materials. When it became obvious to researchers in the 1960s that air leakage into the walls and roofs was a more important source of water migration, authorities began calling for a "continuous vapour barrier."

It was found to be close to impossible, considering the materials that were being used (mostly polyethylene and other **not-so-durable** products.)



A Vapour barrier is: *definition*

- a material that offers a high resistance to the diffusion of **water vapour**.
- is used to separate an environment which is at a high vapour pressure from an adjacent one at a lower vapour pressure.
- For best results, it is important that the vapour barrier be continuous, but it does not have to be perfectly continuous. Unsealed laps or minor cuts do not affect the overall resistance to diffusion significantly.
- The vapour barrier must also be located on the warm side of the insulation or at least in a location in the wall near enough to the warm side to remain above the dew point temperature of the indoor air during cold weather.

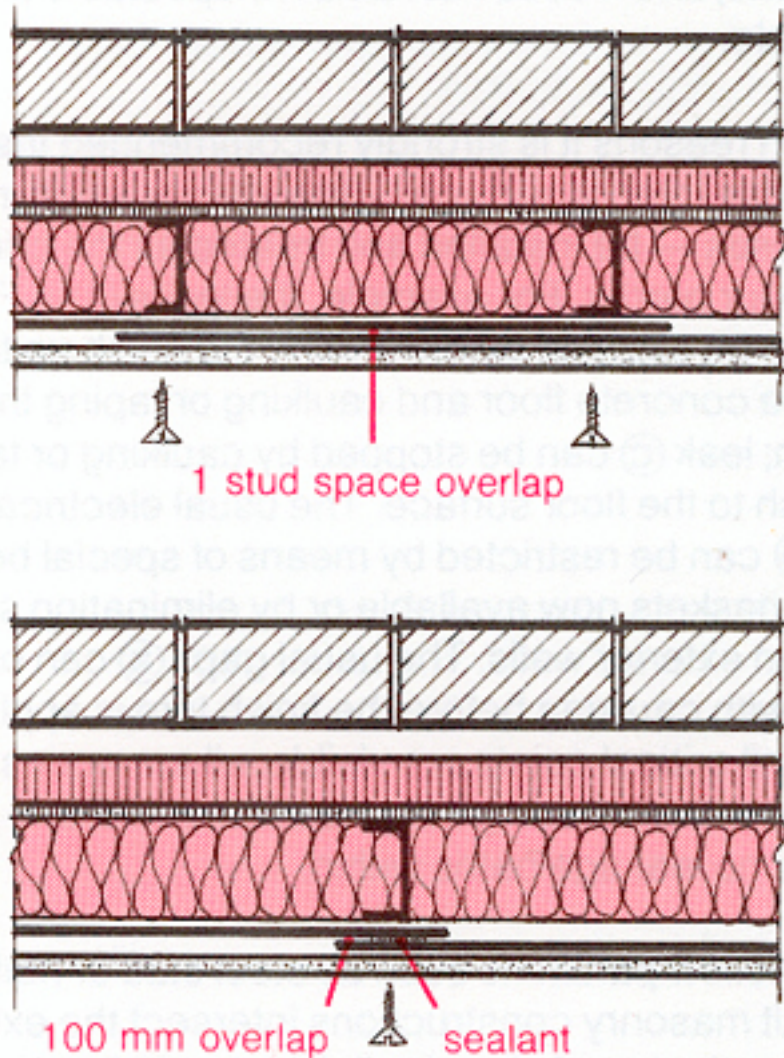
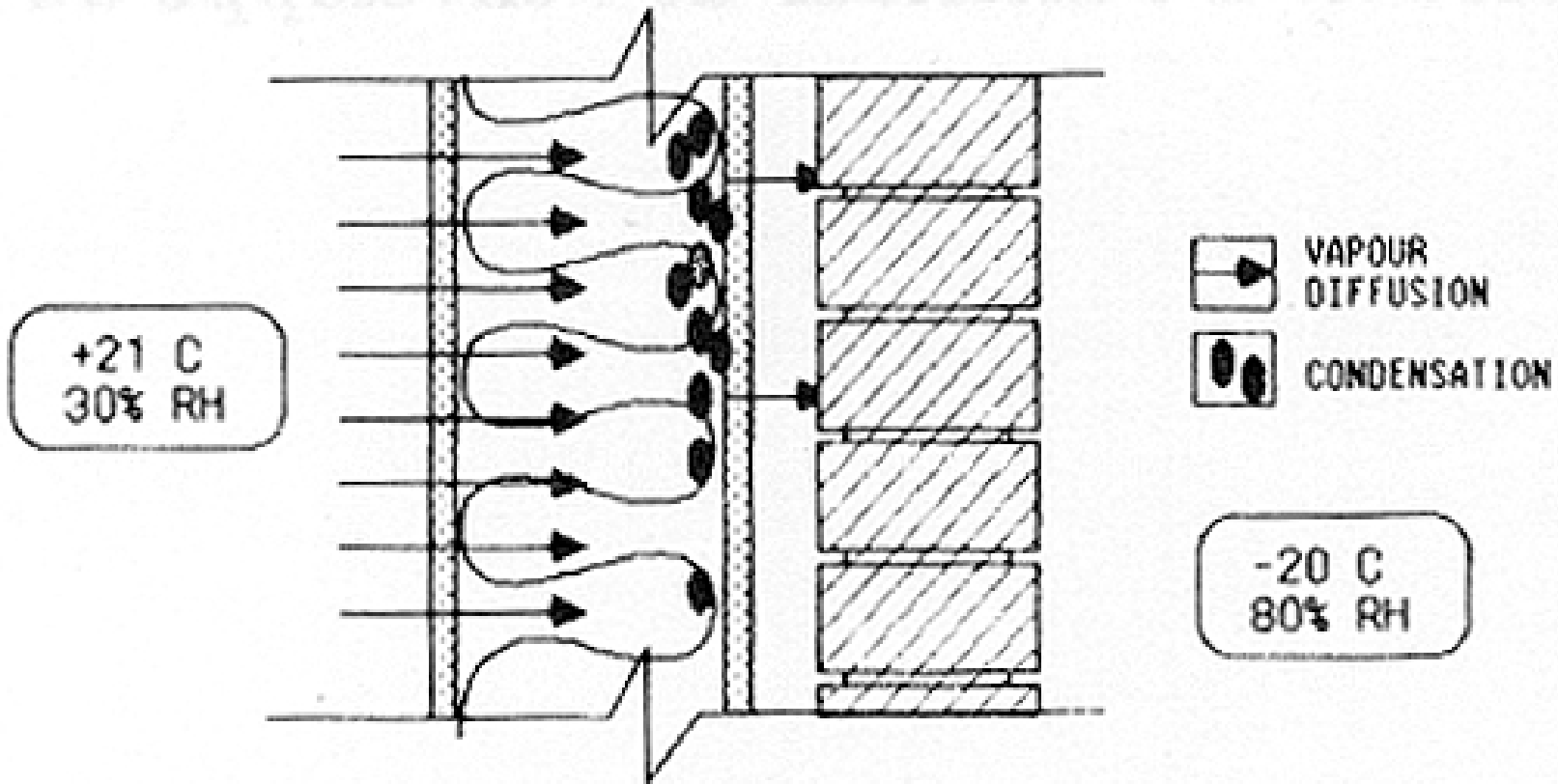

Figure 2.17 Recommended Joints in Polyethelene Air/ Vapour Barrier

This is what used to be suggested for VB installation when it was assumed to be the only method of controlling water in the insulation.

Since the VB only controls 10% of the moisture AND it is installed using staples, there is little point.

Also for many building scientists this VB membrane is considered bad practice with updated Air Barrier installation methods.



WALL WITHOUT A VAPOUR BARRIER

FIG. 1A

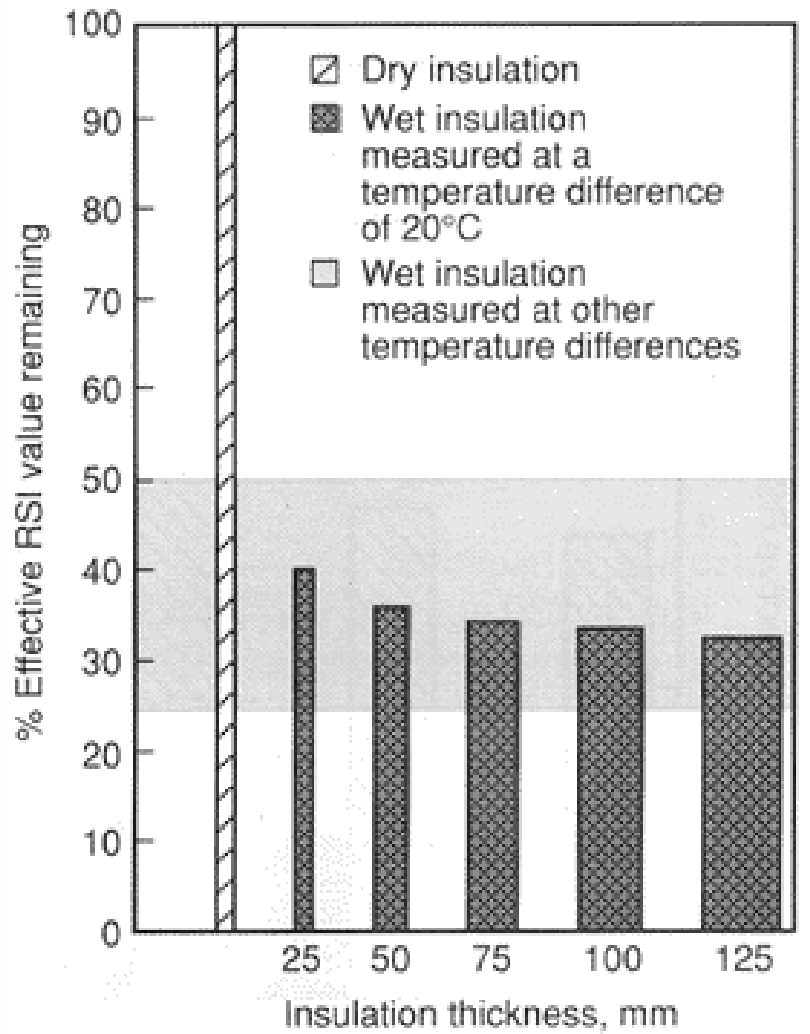

The air and vapour barriers are greatly important in keeping moisture out of the envelope so to keep the insulation DRY.

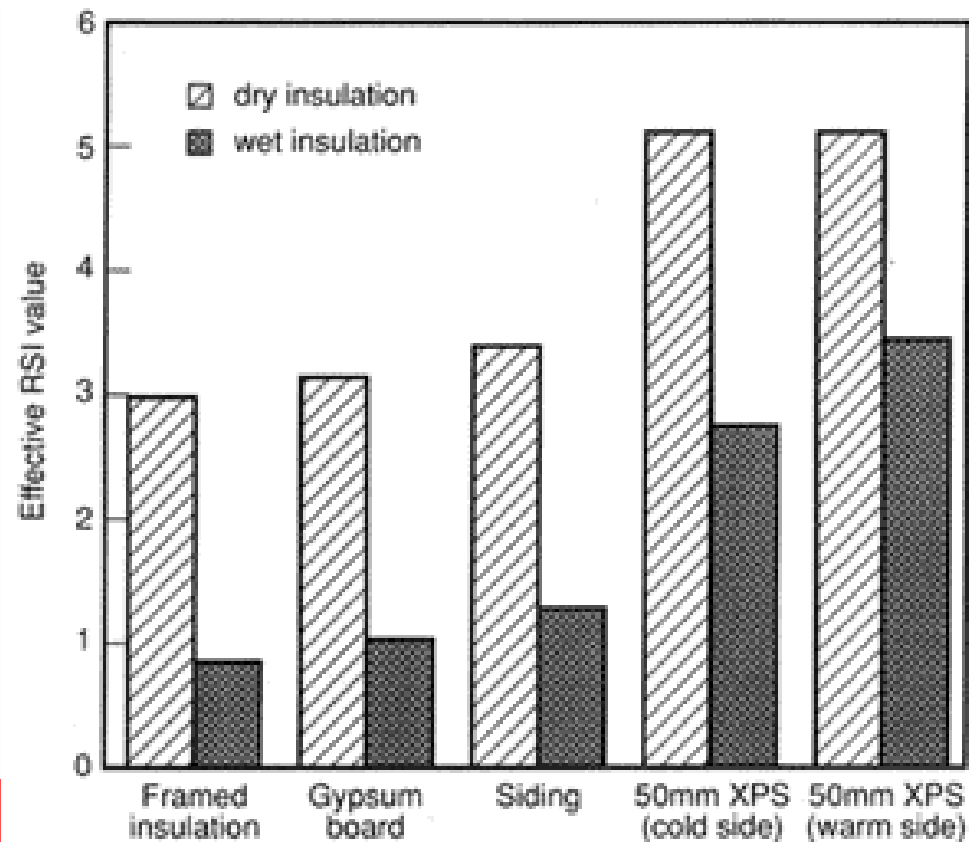

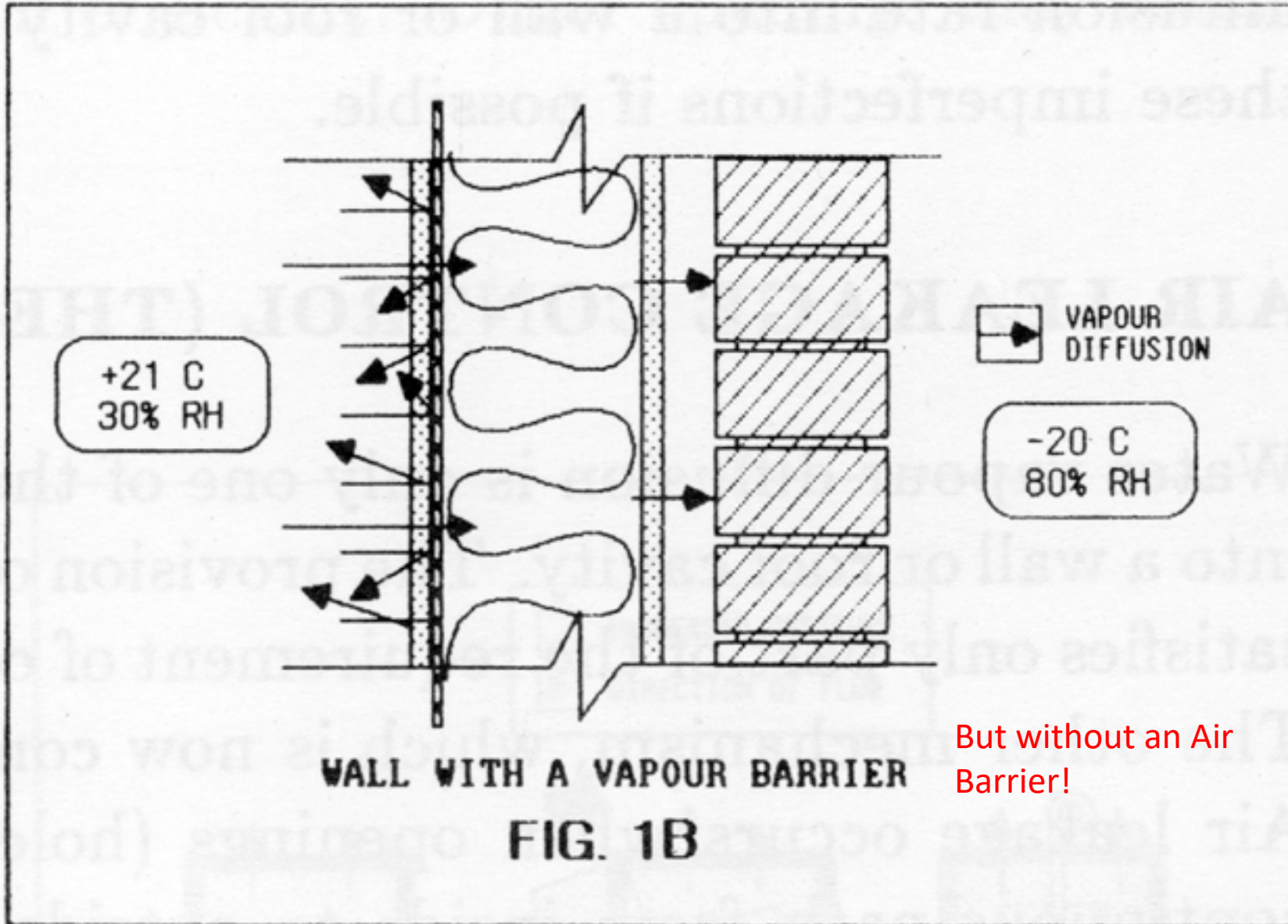

But without an Air Barrier!

The calculated temperature gradients for winter and summer are shown on both wall sections.

Wall No. 1 has the insulation located on inner (or warm) side of the wall construction:

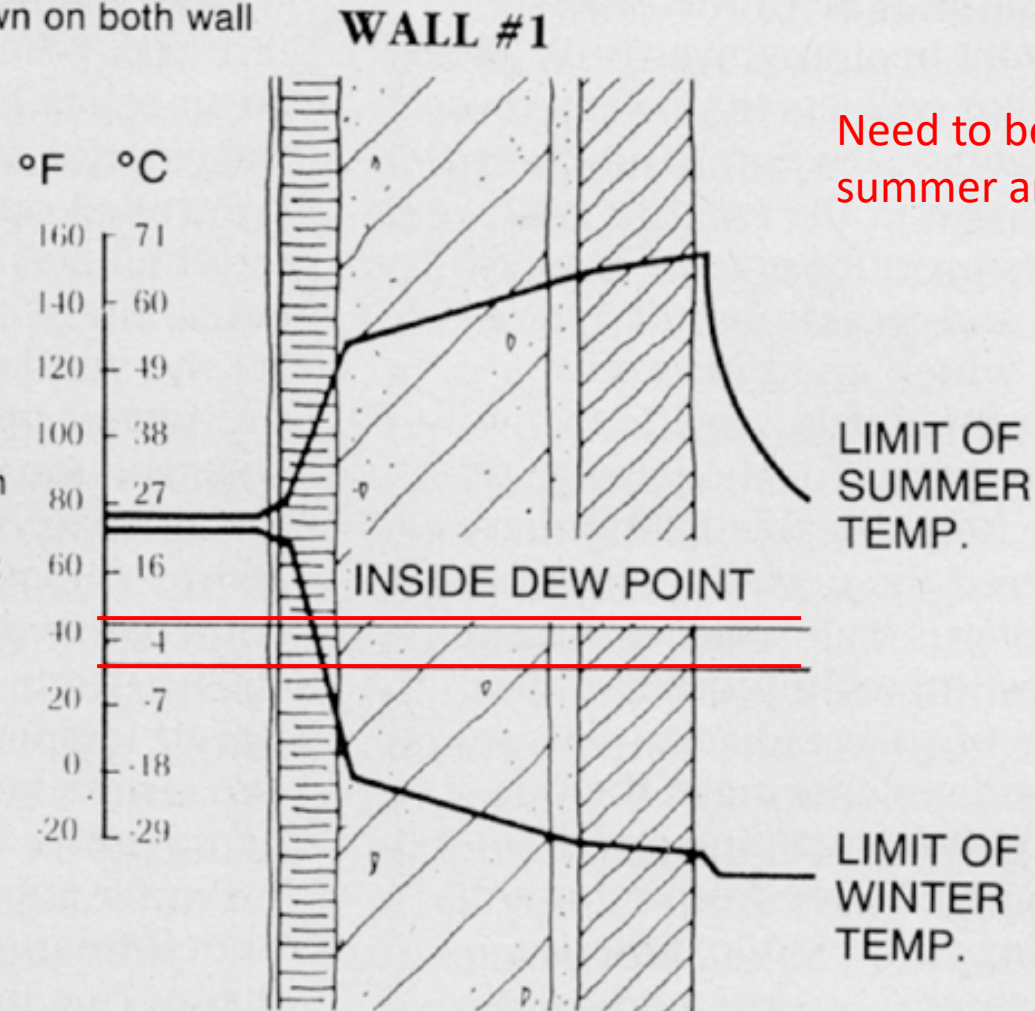

Need to be cognizant of summer and winter conditions!

WALL #2

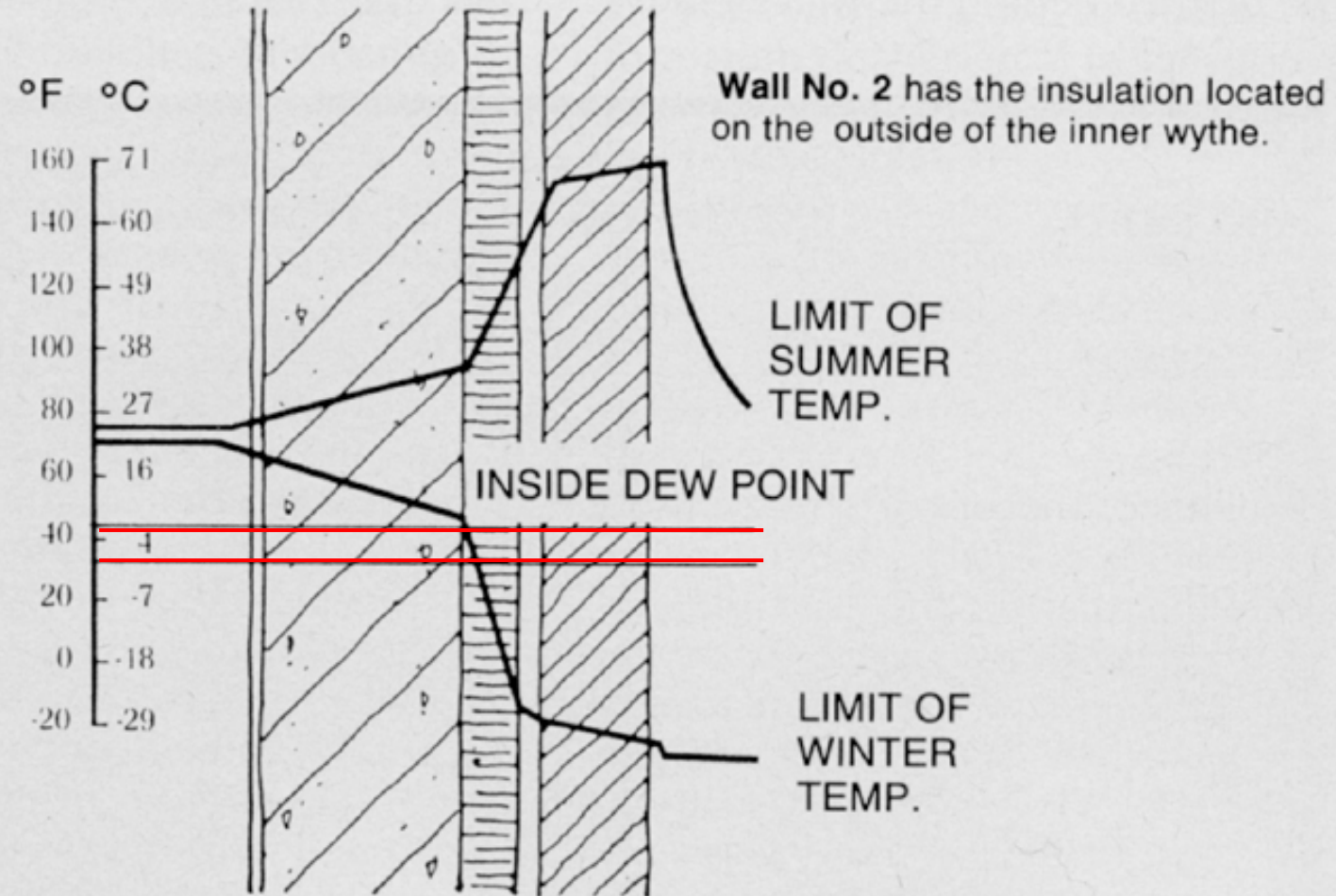

Air Barrier:

The principal function of the air barrier is to prevent both the infiltration of outdoor air into a building and the exfiltration of indoor air to the outside. This applies whether the air is humid or dry. Air leakage can cause problems other than the deposition of moisture in the walls, such as loss of energy and infiltration of rain.

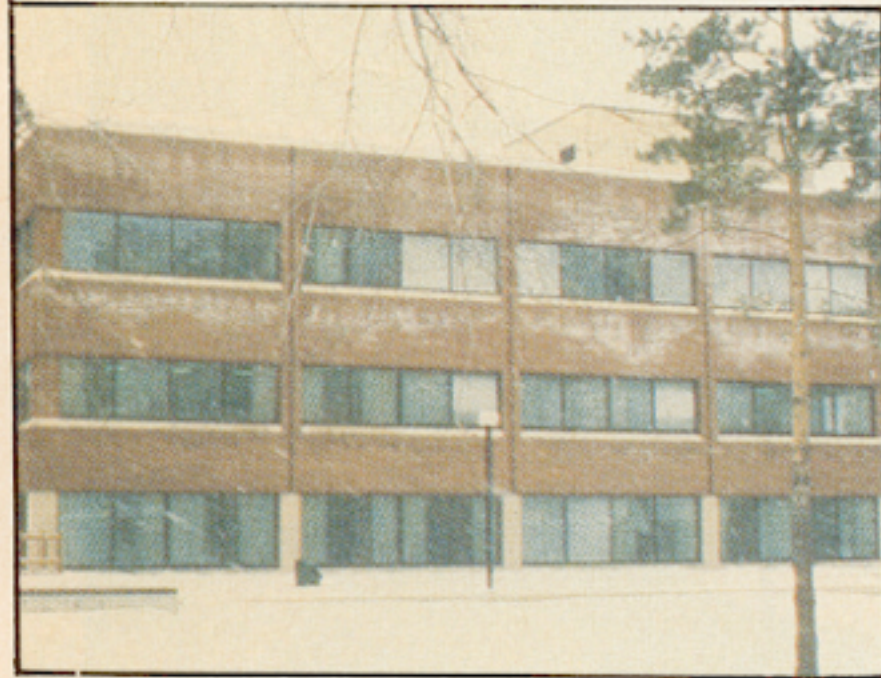

Efflorescence on masonry
(Photo 1)

In 1964, Mr. N. Hutcheon wrote in Technical Paper No. 188, Division of Building Research, NRCC:

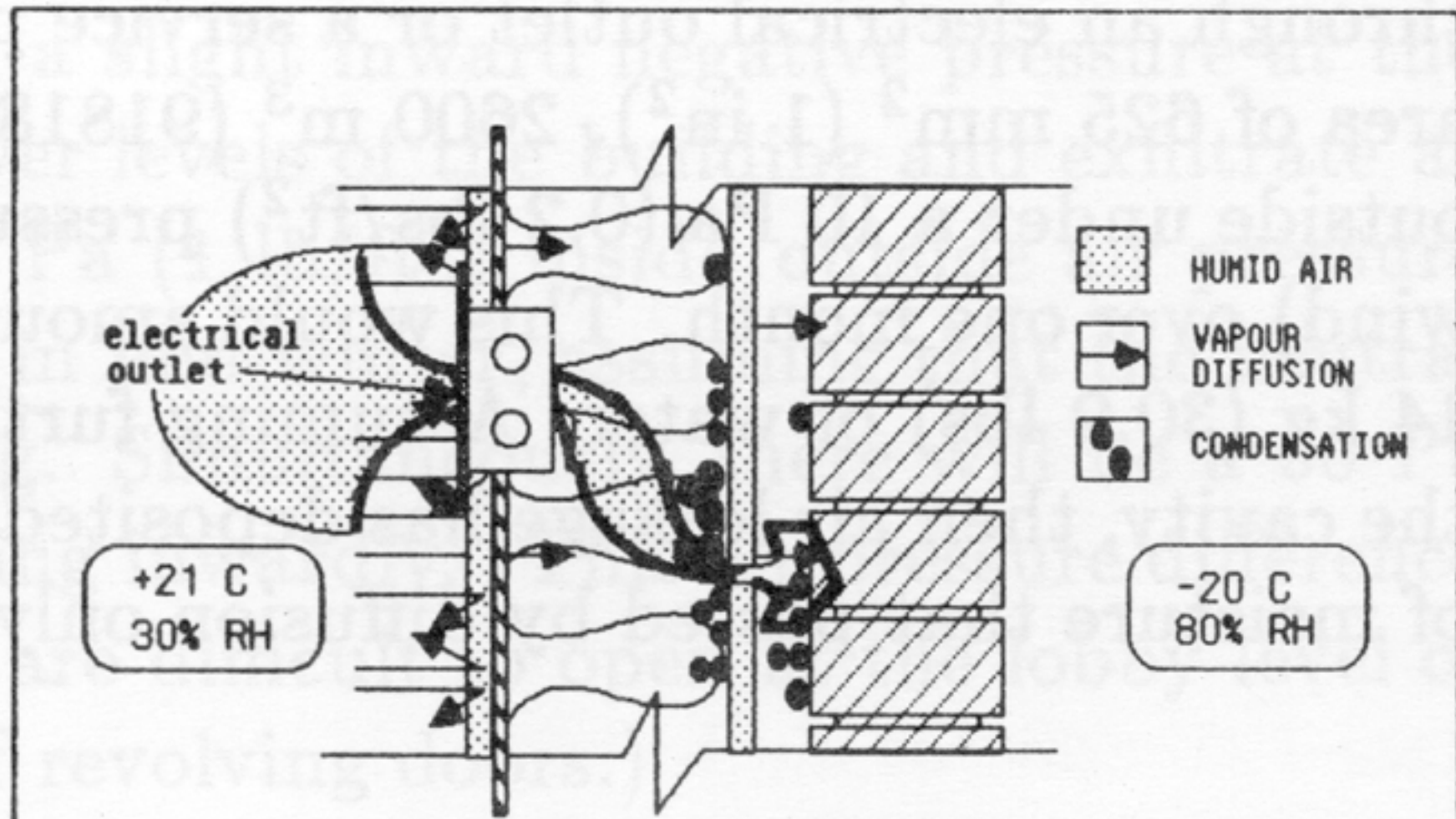

WALL WITH VAPOUR BARRIER
 PREVENTS VAPOUR DIFFUSION BUT NOT AIR LEAKAGE

FIG. 2

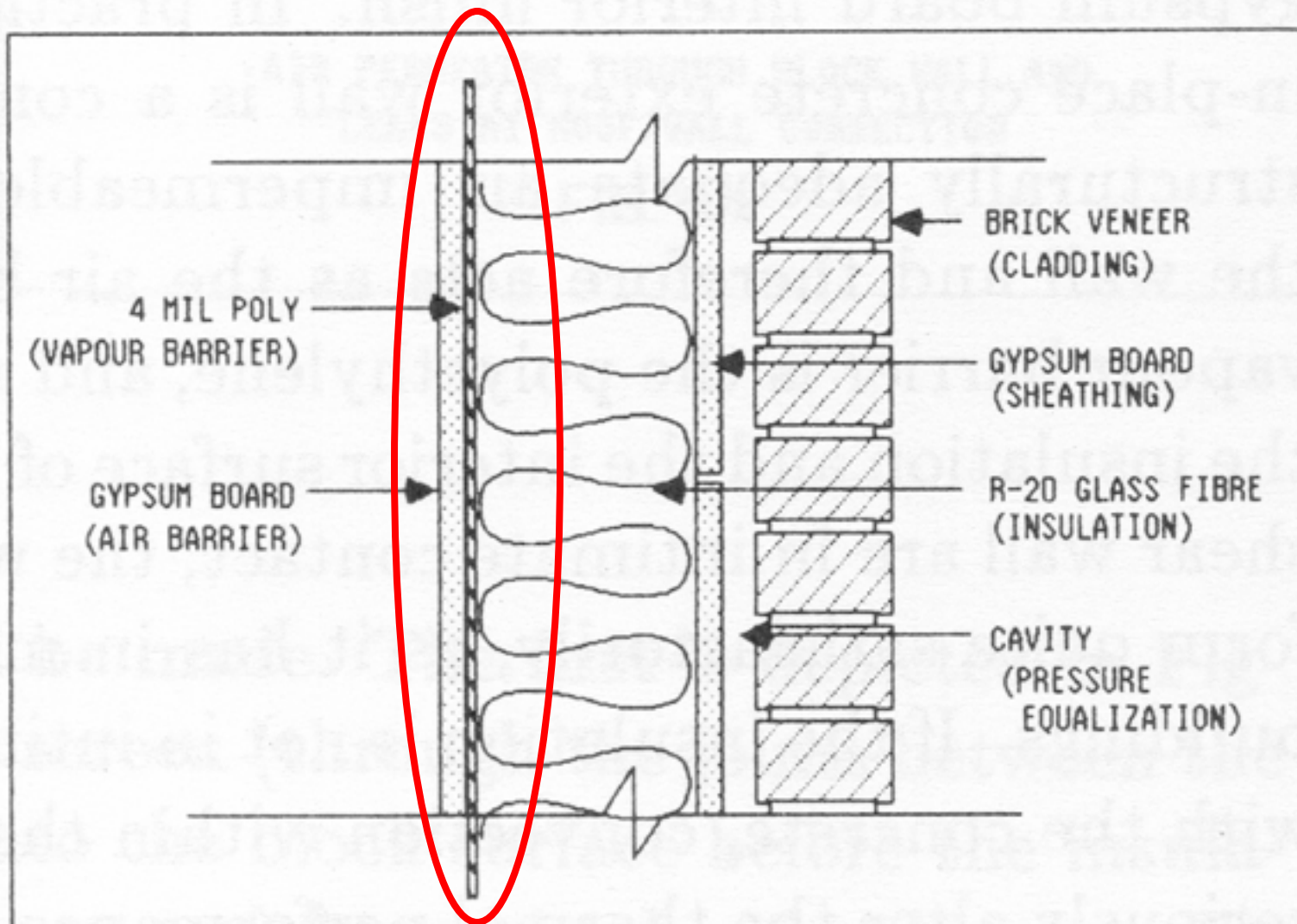

SEPARATE AIR AND VAPOUR BARRIERS

FIG. 7

DIFFERENCE BETWEEN VAPOUR AND AIR BARRIERS:

<ul style="list-style-type: none">• vapour barrier stops air diffusion - movement THROUGH the wall	<ul style="list-style-type: none">• air barrier stops air movement - movement through CRACKS in the wall
<ul style="list-style-type: none">• vapour barrier is usually a PRODUCT (like poly film)	<ul style="list-style-type: none">• air barrier is a SYSTEM
<ul style="list-style-type: none">• joints are not a problem, ie. continuity not an issue	<ul style="list-style-type: none">• air barrier must be CONTINUOUS and all joints between different materials SEALED
<ul style="list-style-type: none">• not necessarily durable	<ul style="list-style-type: none">• durability important

Different material combinations will call for different products and methods of creating the air barrier **system**.

Masonry, for example...

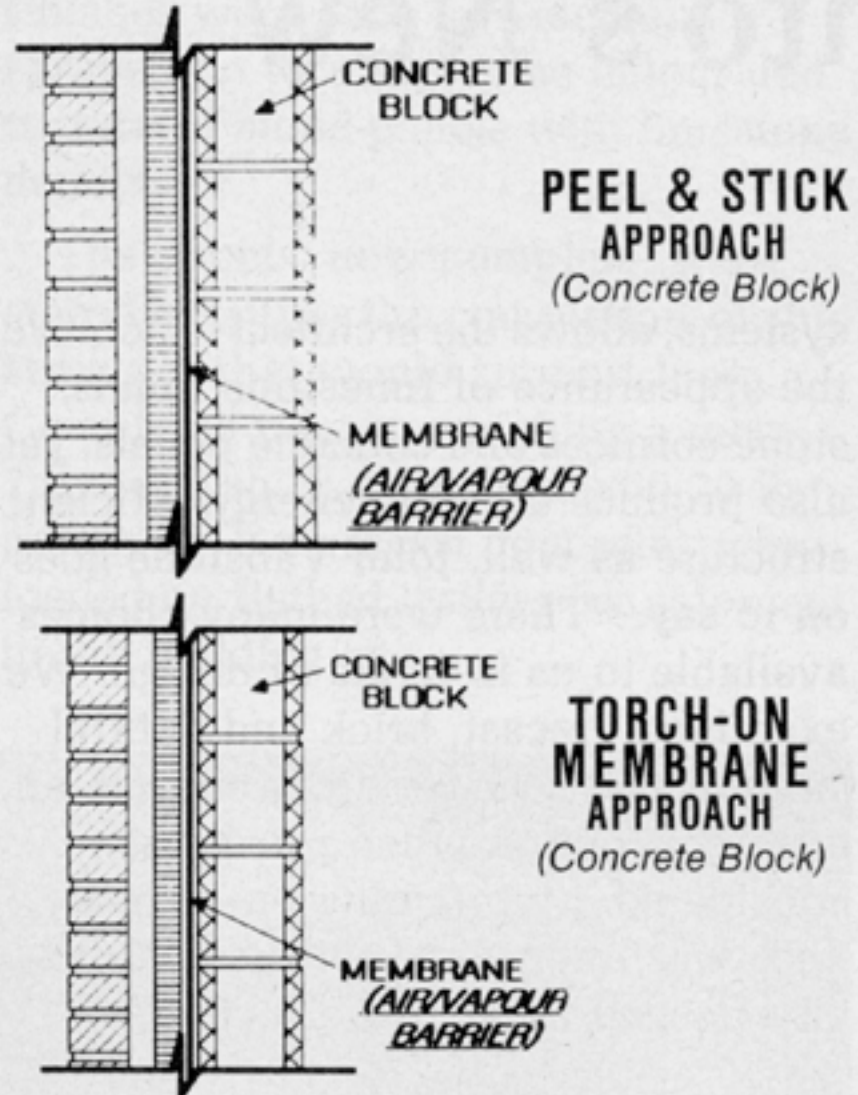

Fig. 7 & 8:
Applied Membrane Air Barriers

Air barrier design criteria:

Continuity:

Continuity:

Continuity means more than being without holes.

Because the component that performs the role of the air barrier changes from the wall to the window to the roof, continuity means that all these assemblies must be connected together so as to ensure that there is no break in the airtightness of the envelope.

AIR BARRIER CONTINUITY

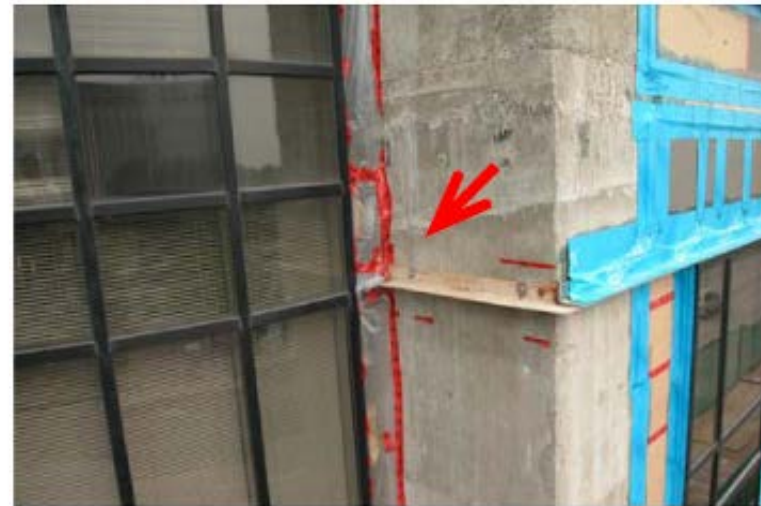
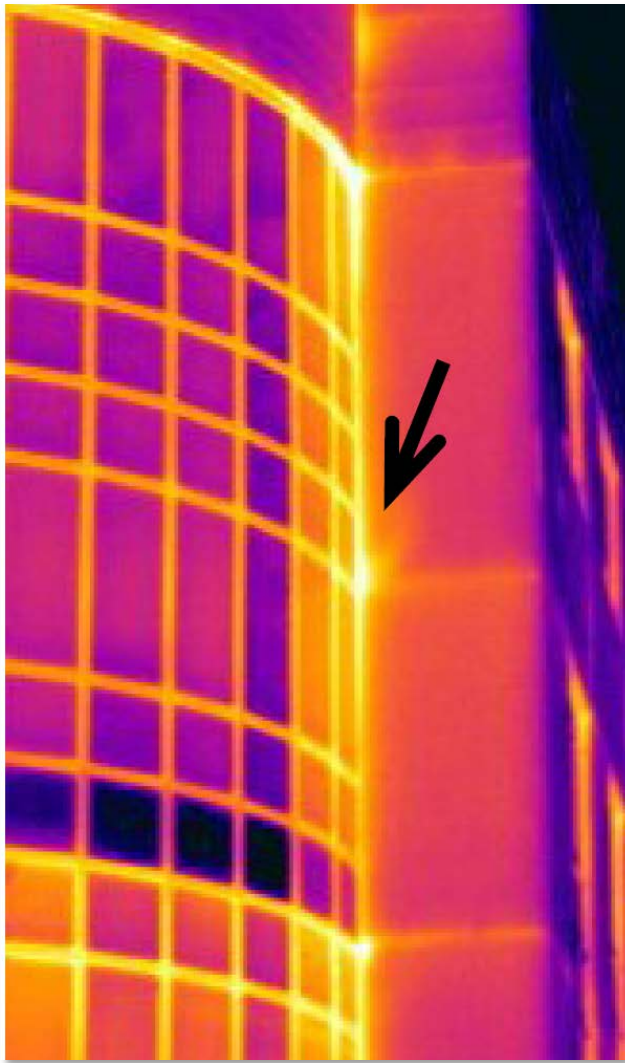

There are so many places that air can leak! Between every junction of materials.

Old construction methods never took account of this and large gaps were (and still are) considered "normal".

Be cautious of diagrams that you see published as these have a bad thermal bridge which is BAD.

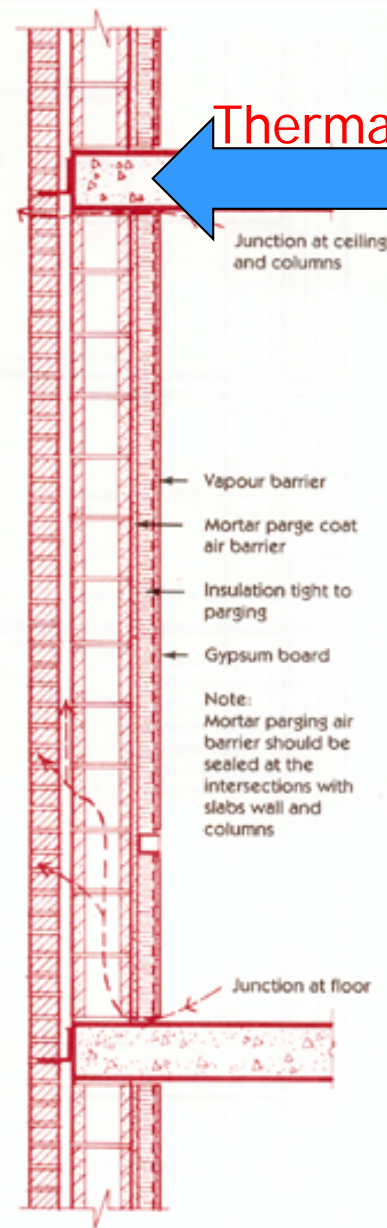

Fig. 18 Parge coat air barrier requires sealing at junctions with ceiling floor slabs and columns (ties, flashings and weepholes not shown)

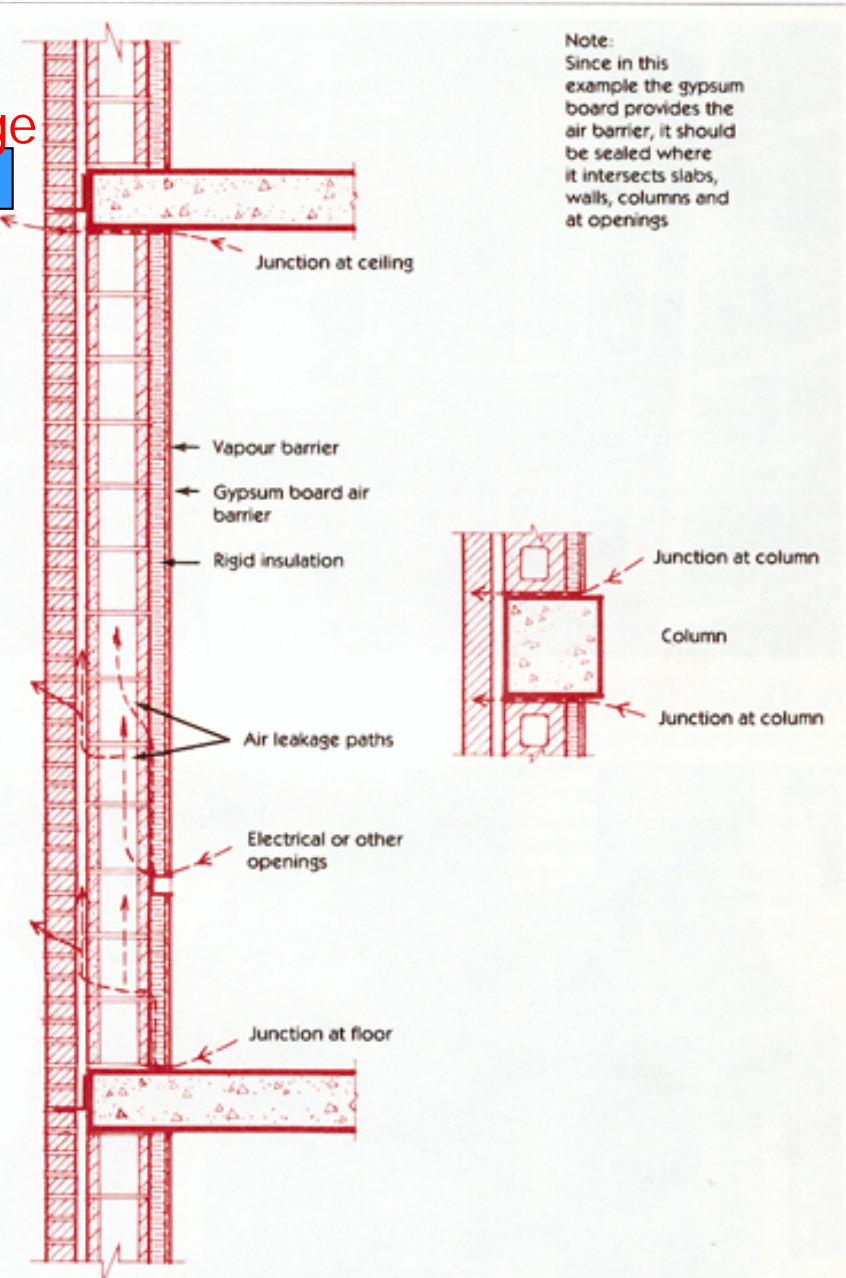
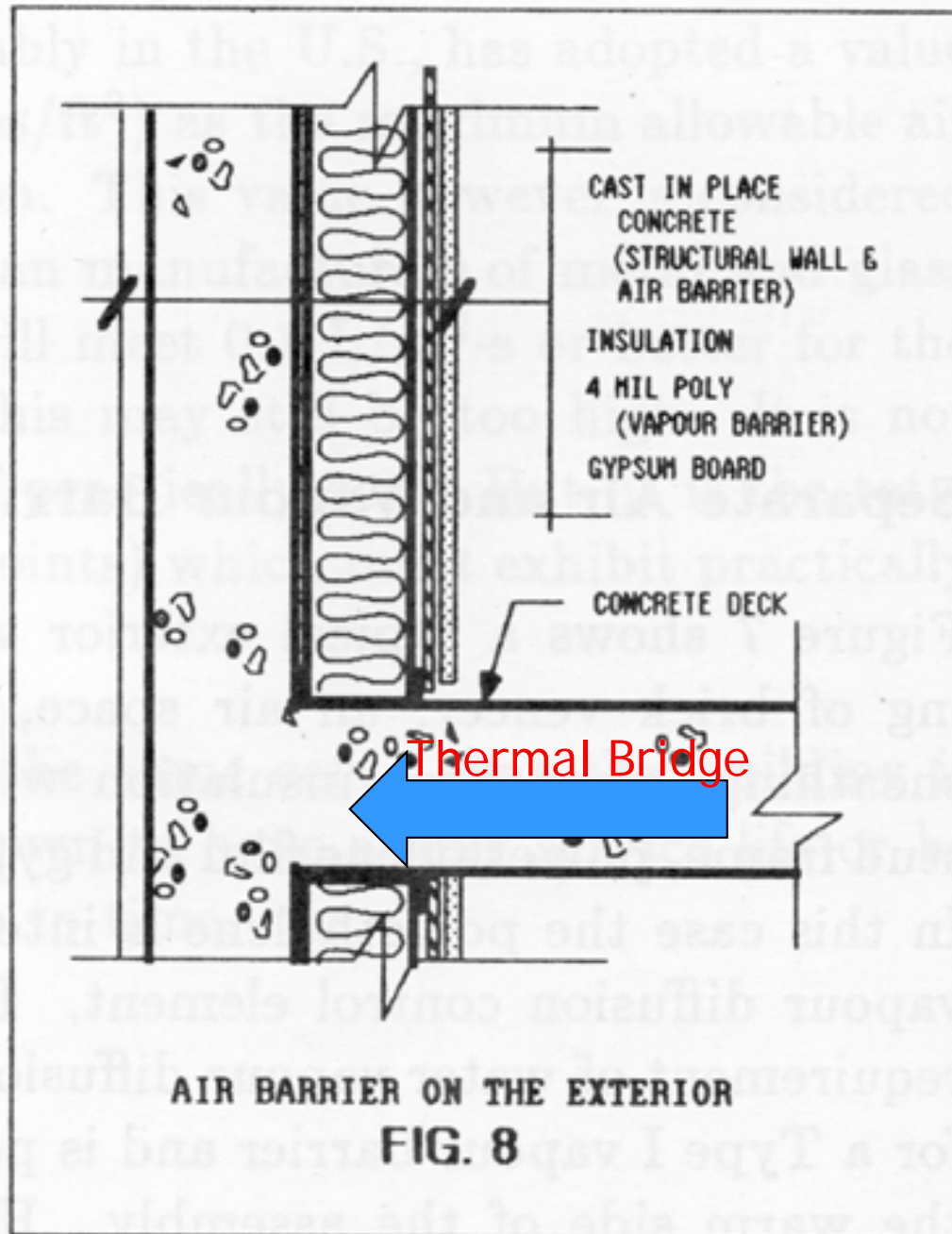

Fig. 17 Air leakage paths in brick veneer on concrete block backup to be taped or otherwise sealed (ties, flashings and weepholes not shown)



*don't always trust
what you
see...read...think....be
skeptical!*

This image is from a Canadian government publication on air barriers. Concrete may be an excellent air barrier, *but what is wrong with this detail??*

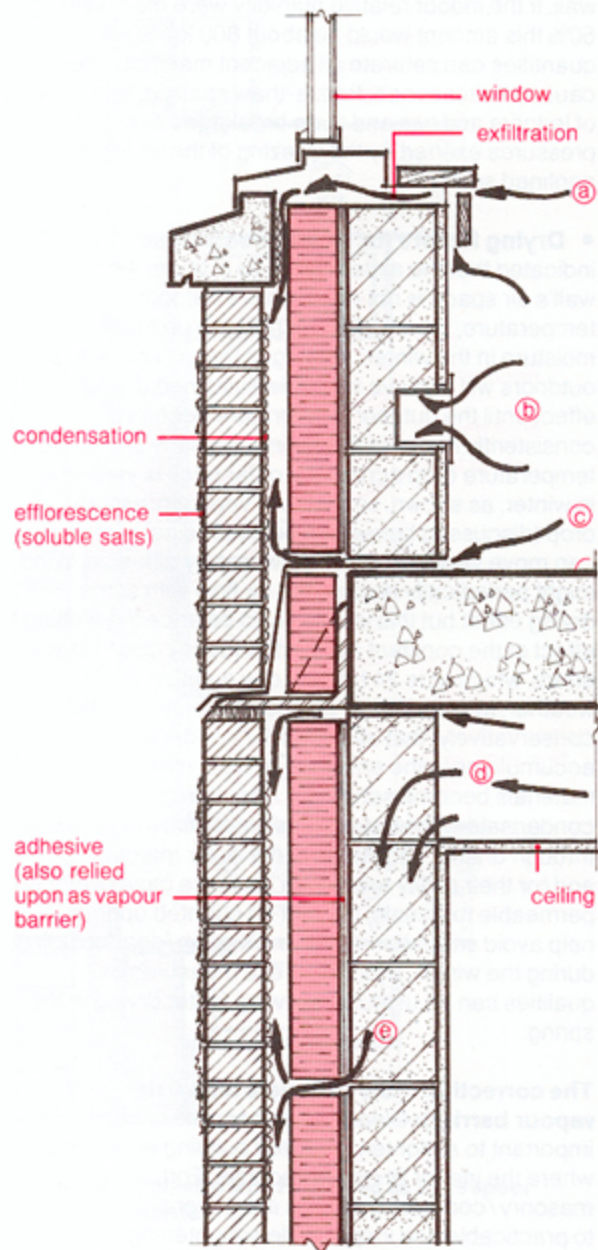

Figure 2.15 Exfiltration/Condensation Example Pattern (leakages a to e are discussed in the text)

Detailing around junctures in the wall, where windows and other openings occur, becomes an important aspect of wall design as much leakage can occur at these “weak” points in the wall assembly.

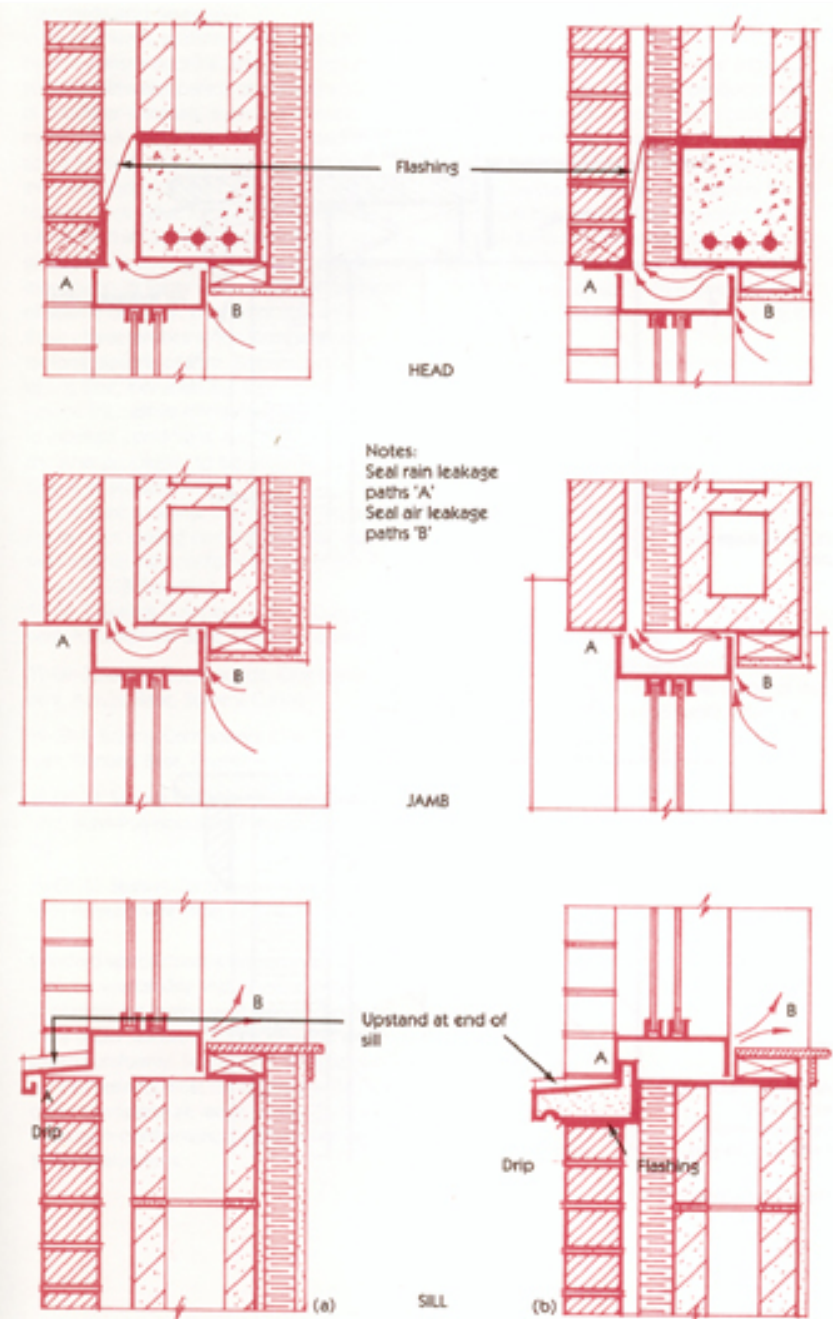

Fig. 44 Air leakage at window to wall connection

Not only insulation should be continuous in the unending battle against thermal bridges, but all material intersections must be sealed with materials that are both **durable** and **inspectable/repairable**

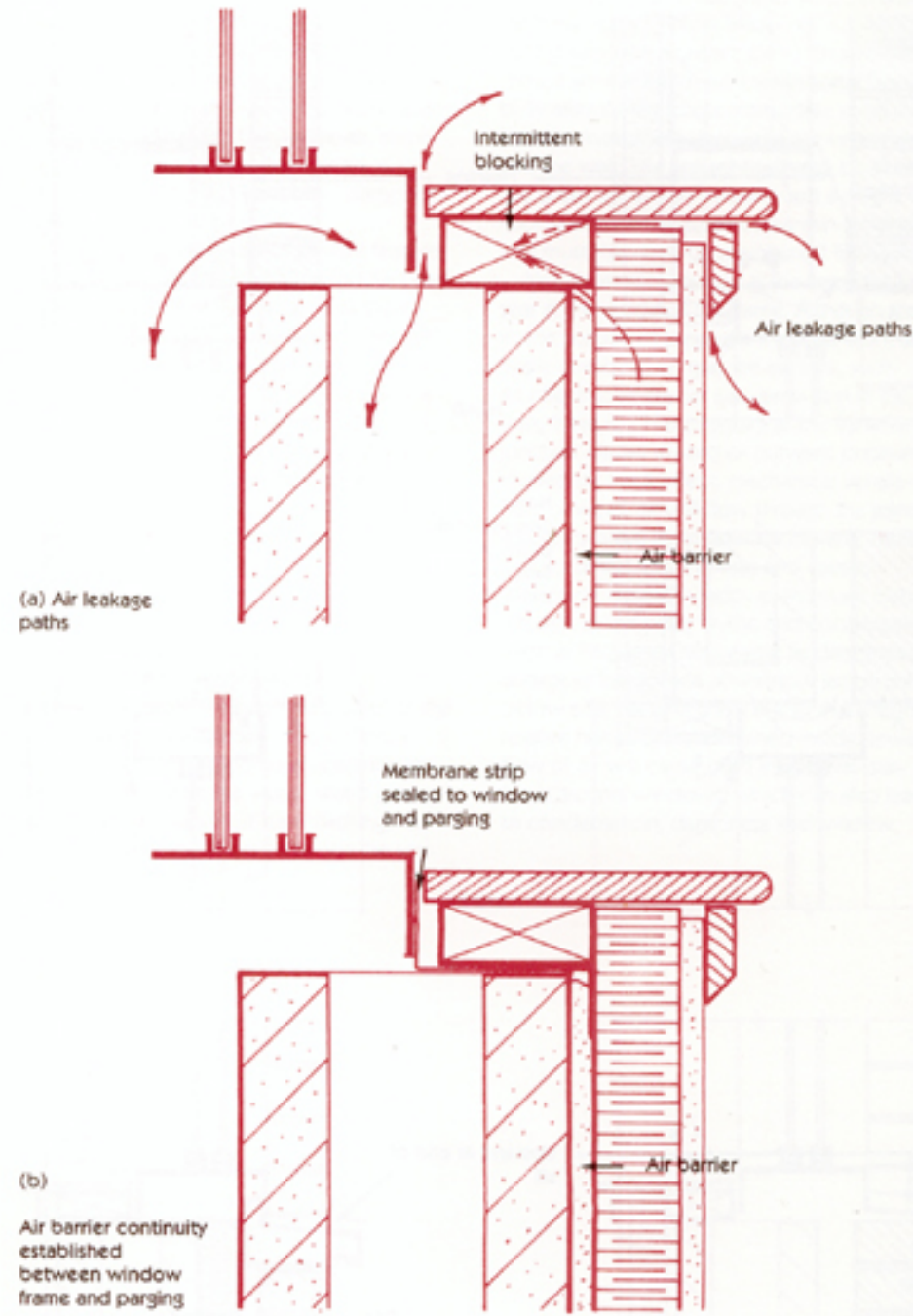
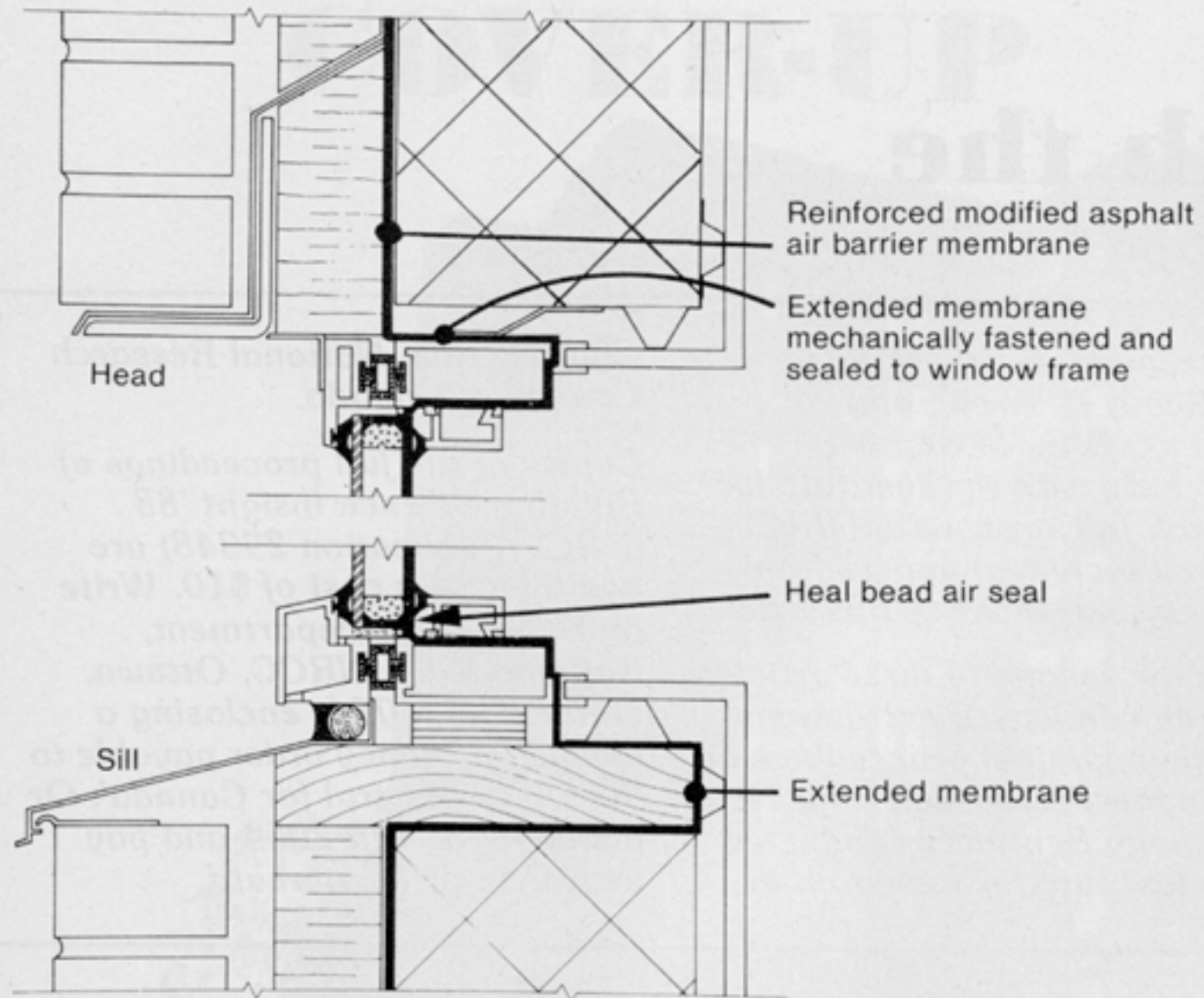
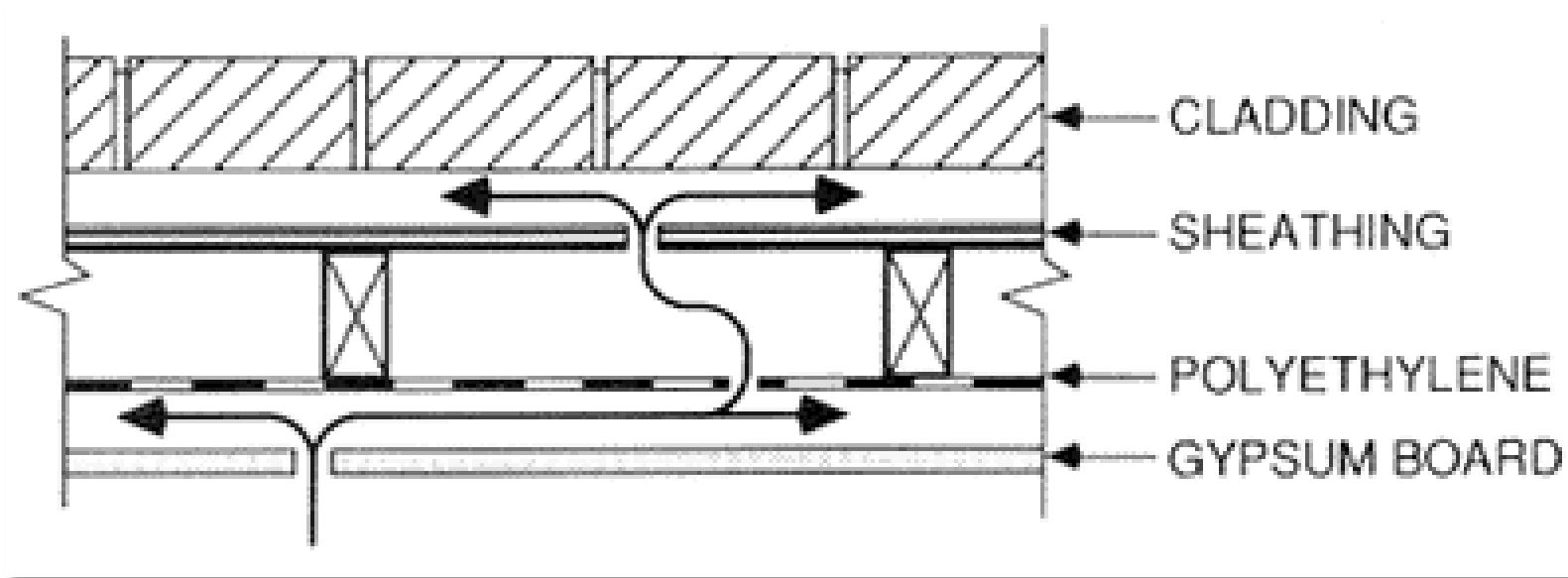

Fig. 45 Air leakage at sill

Fig. 1 Commercial Window





Air flow path: all of the joints in the system must be identified and sealed. Such seals must be of durable long lasting materials OR be in such a place as to be able to be inspected periodically and repaired.

The gypsum system must ensure that all cracks are sealed, not only those at the base and top of the wall system.

Air barrier design criteria:

Structural Integrity:

Structural Integrity:

The component designed to be the air barrier must itself be capable of resisting the imposed load or must be supported by one that can. It must be capable of resisting the strongest wind load acting either as a pressure or suction without rupturing or breaking away from its support. The air barrier must not detach itself from its support or fail in creep under a sustained pressure resulting from stack effect or fan pressurization or exhaust. The air barrier and its support must be sufficiently rigid to resist displacement.

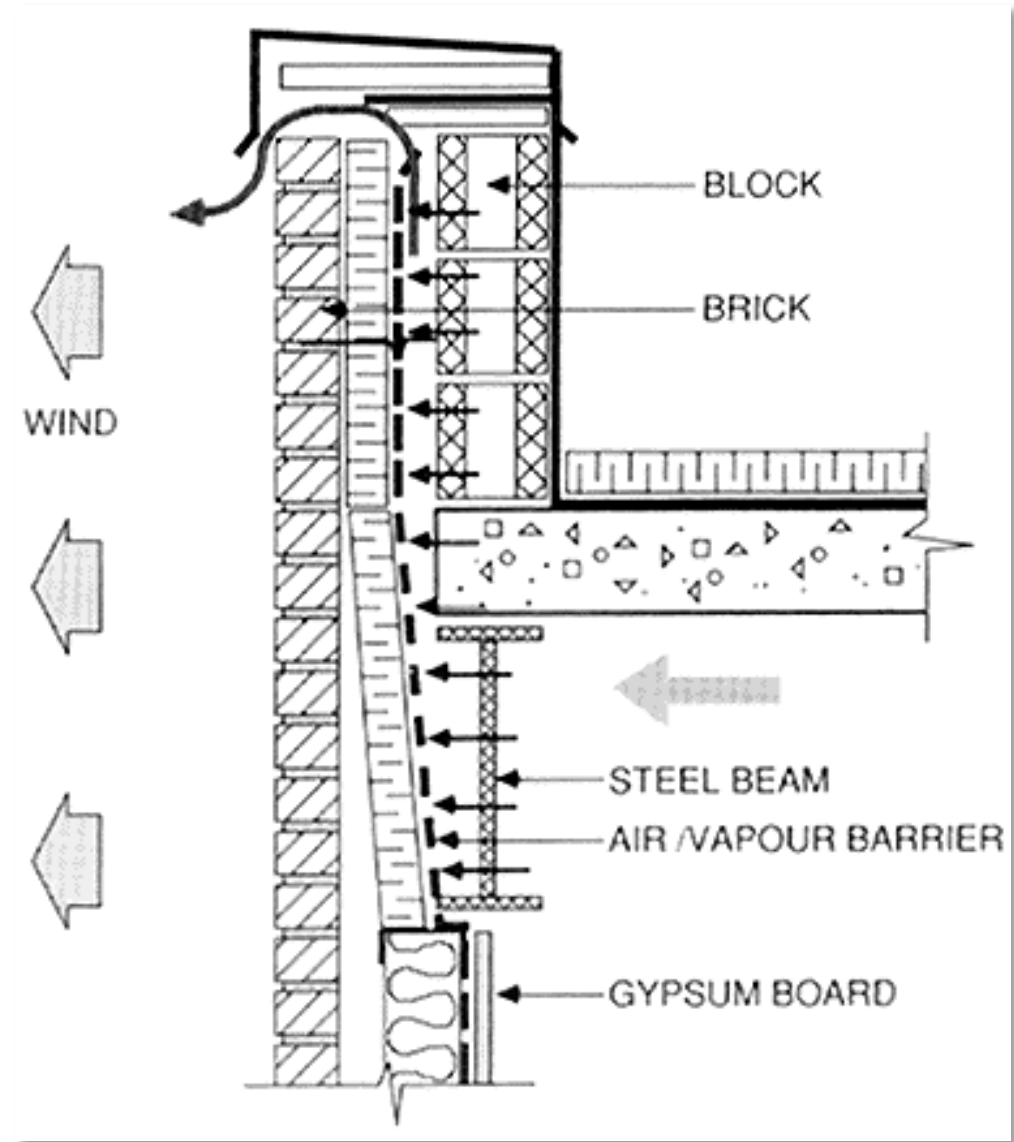

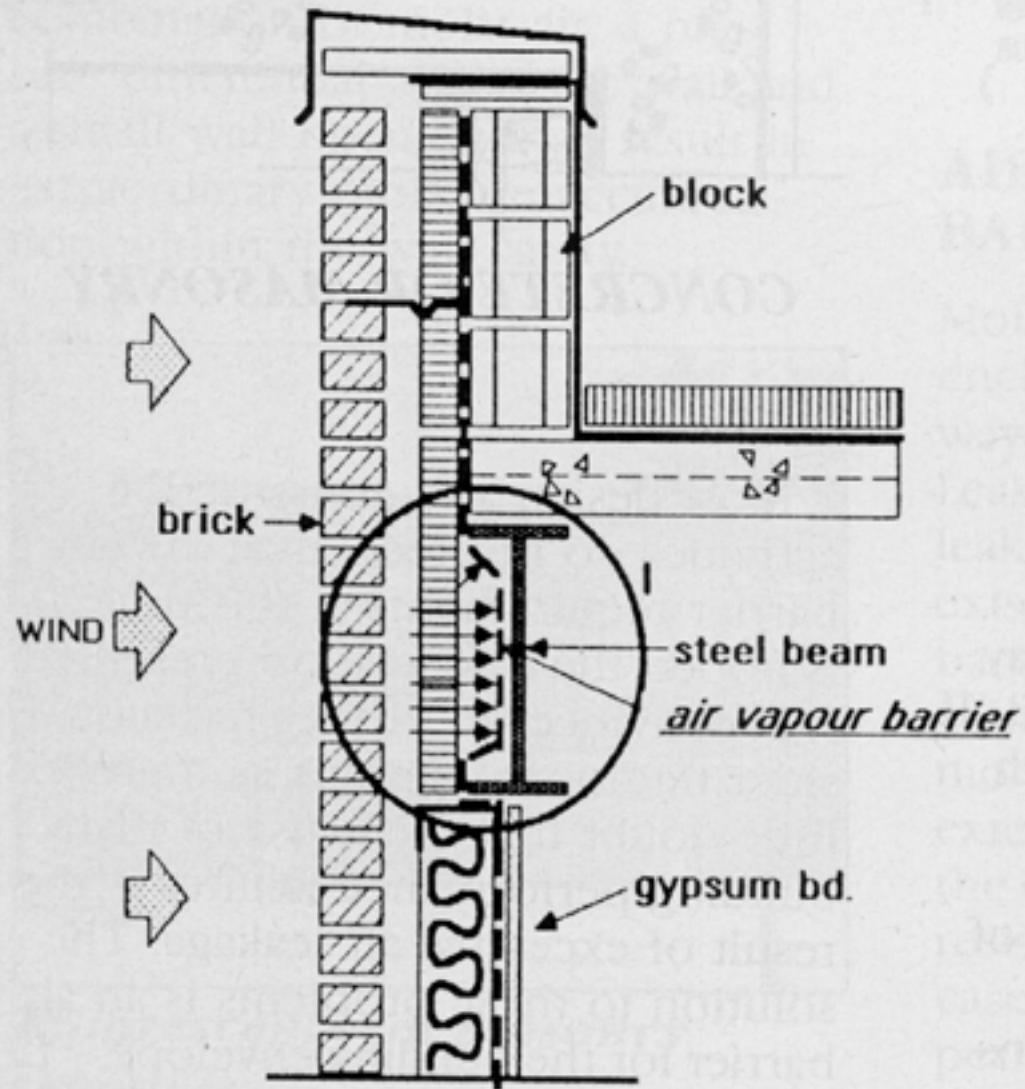

**AIR BARRIER RESISTS
DISPLACEMENT**

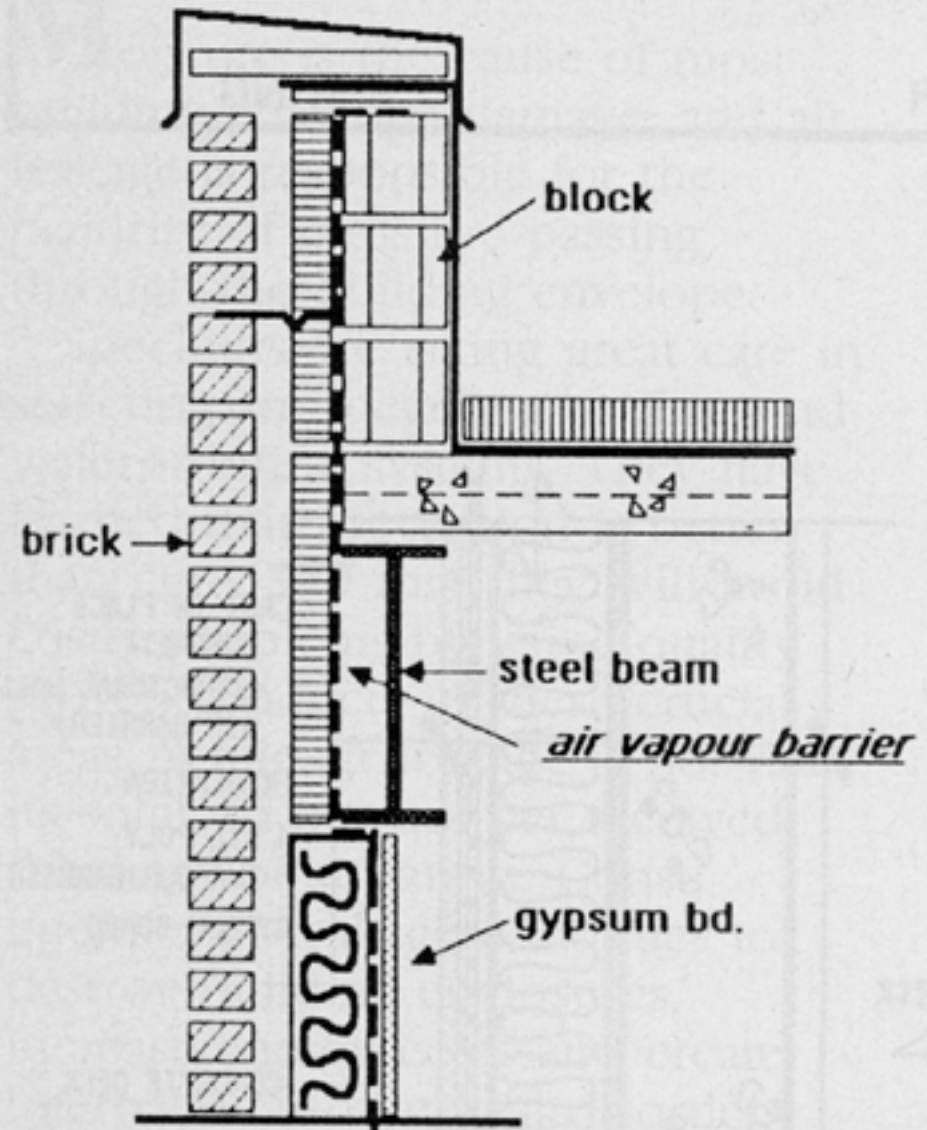

**PROPER SUPPORT FOR AIR
BARRIER**

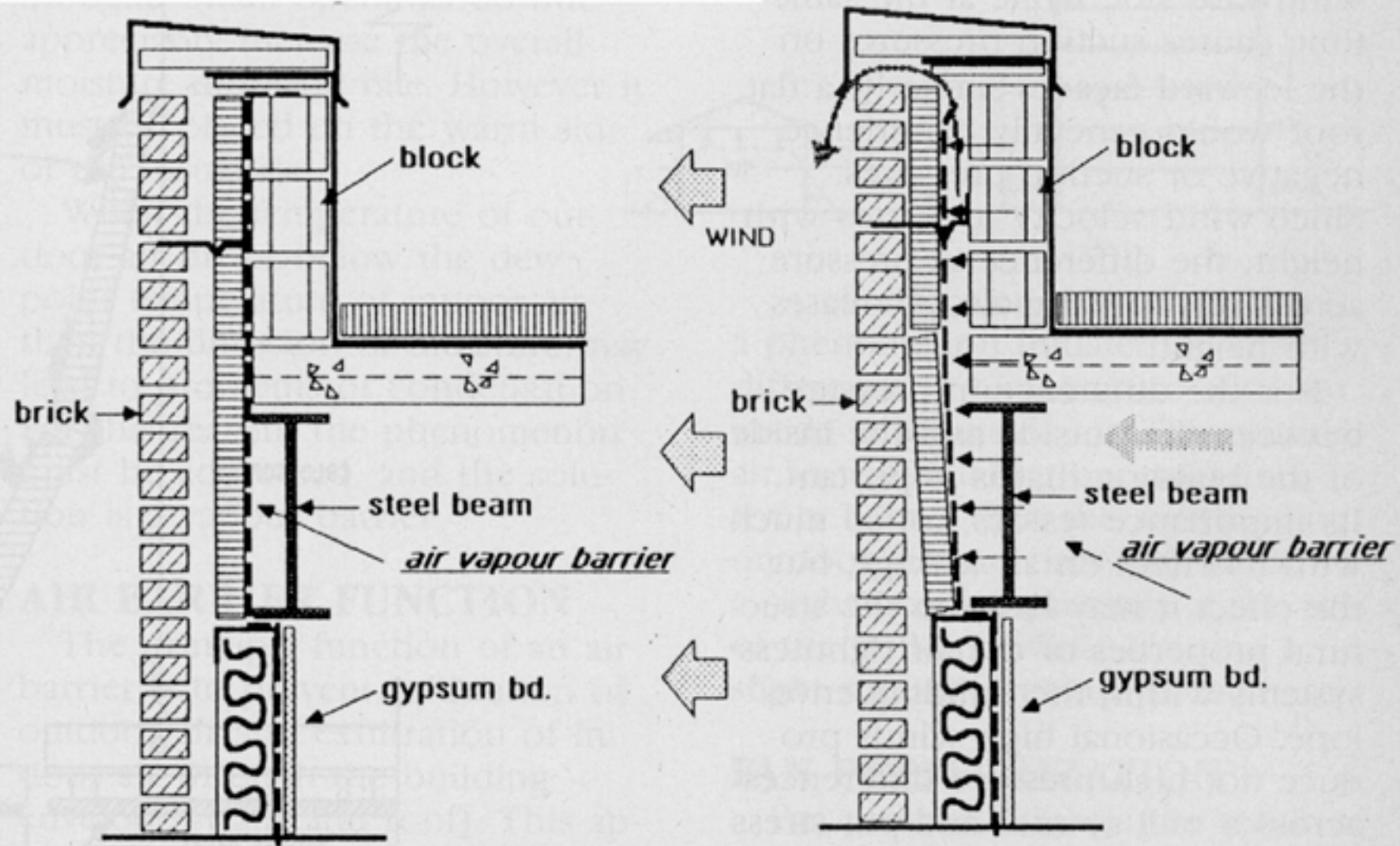

***INADEQUATE SUPPORT
FOR AIR BARRIER***

***AIR BARRIER
DISPLACEMENT***

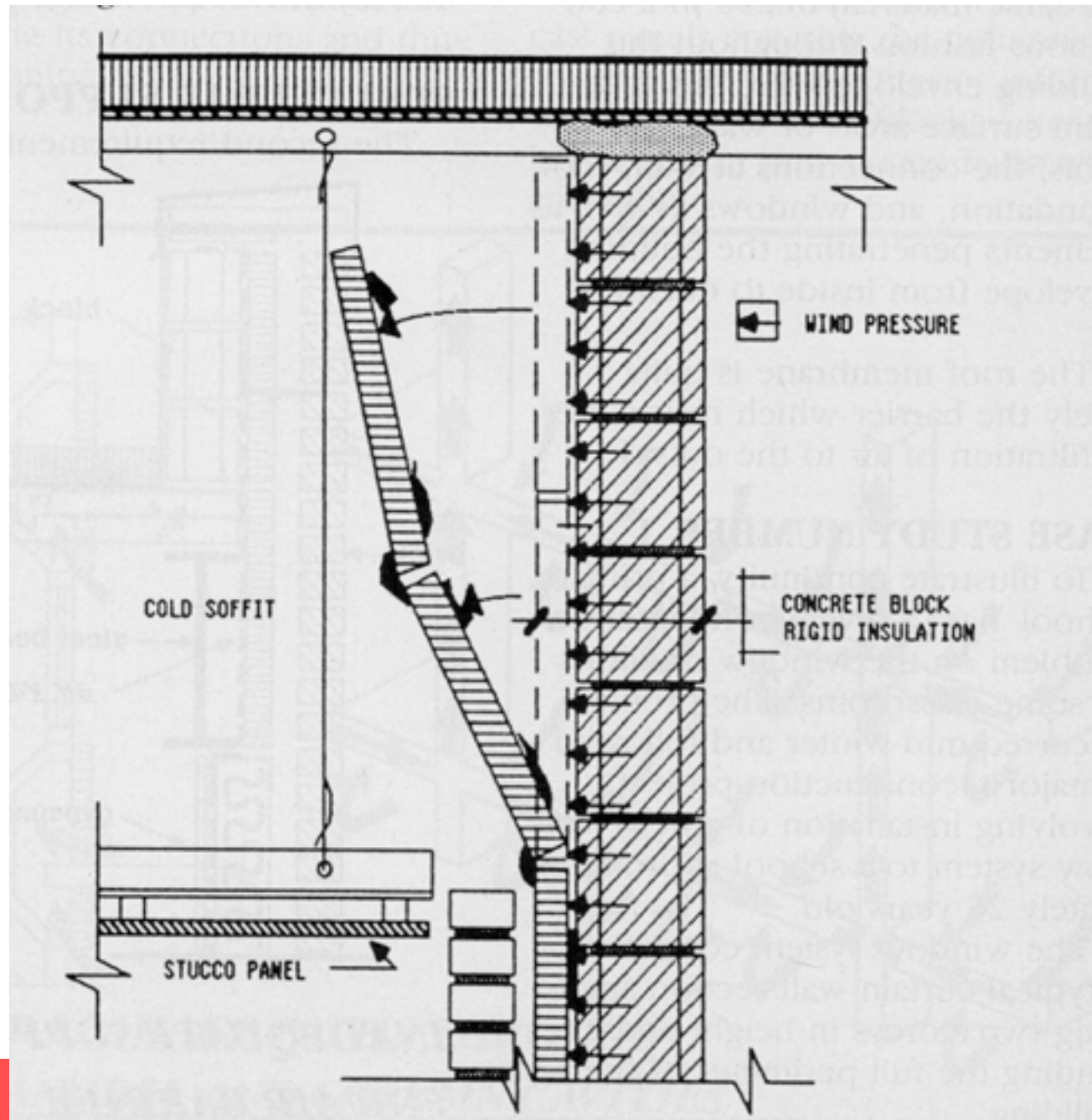

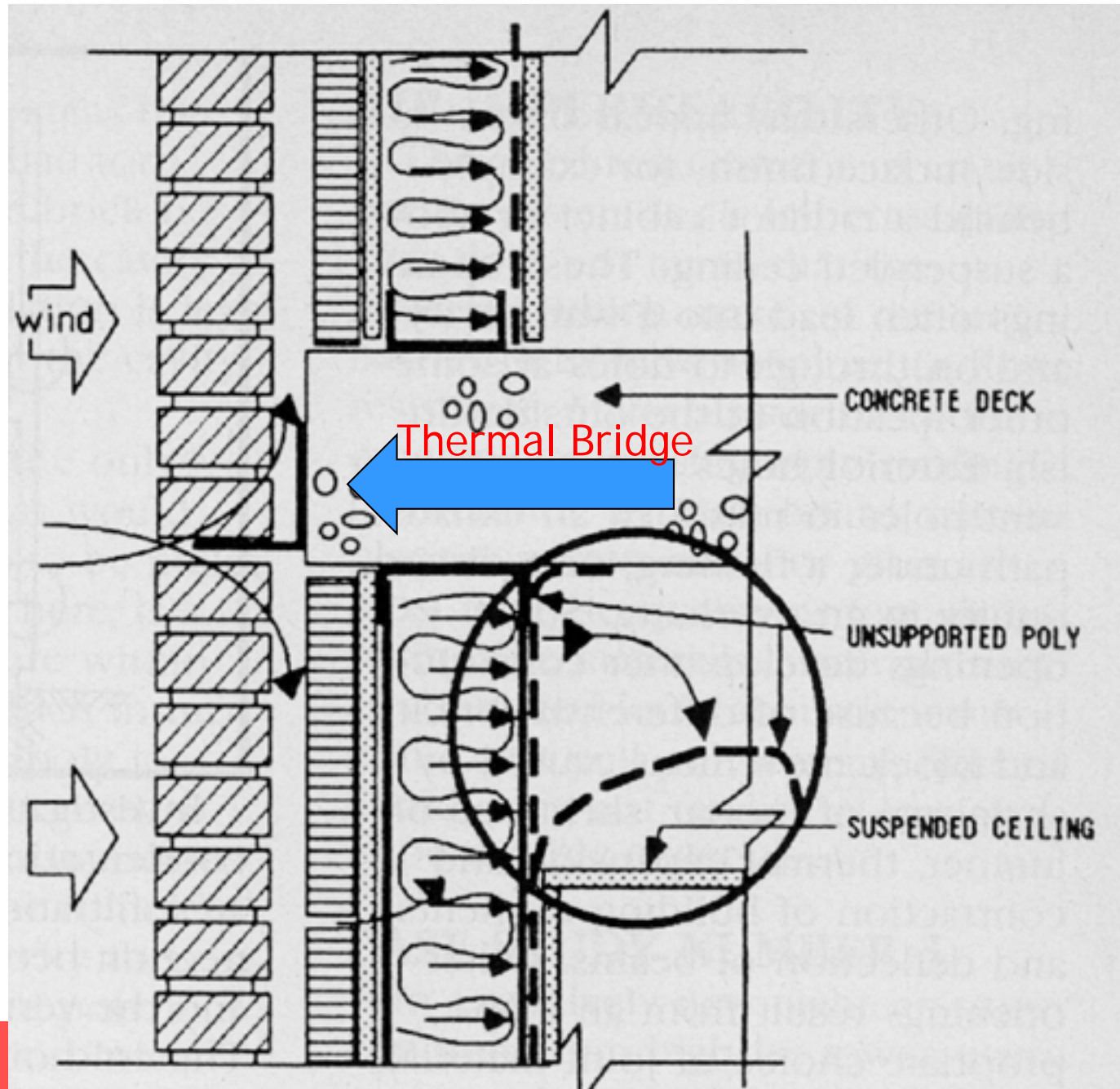



New product to prevent thermal bridging in cantilevered concrete slab (balconies).

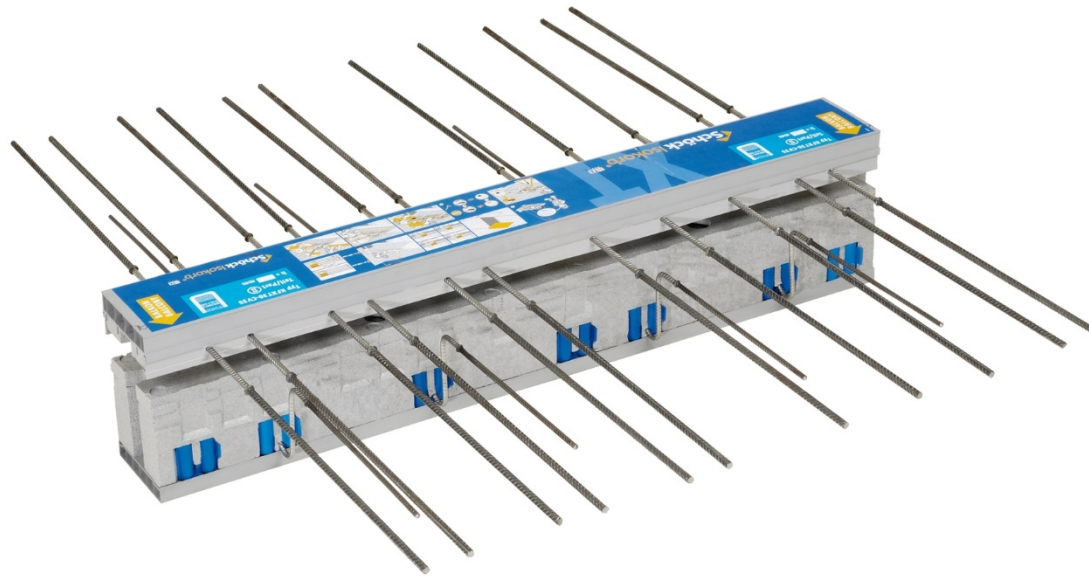

http://www.schoeck.co.uk/en_gb/solutions-uk/cantilever-structural-components-7c

Air barrier design criteria: *Impermeability:*

Air Impermeability

A major requirement of an air barrier is that it offer a high resistance to air flow. While absolute air impermeability may not be required, materials such as **glass, sheet metal, gypsum board, cast-in-place concrete and a properly supported polyethylene sheet** offer a much higher resistance to air flow than do more porous materials such as concrete blocks, fibre board sheathing, and expanded polystyrene insulation. **A second major consideration is that individual panels be joined into an airtight assembly.** The joints between gypsum boards can be taped quickly and effectively, sheet metal panels can be lapped with tape, precast panels can be sealed with rope and sealants, etc.

Impermeability:

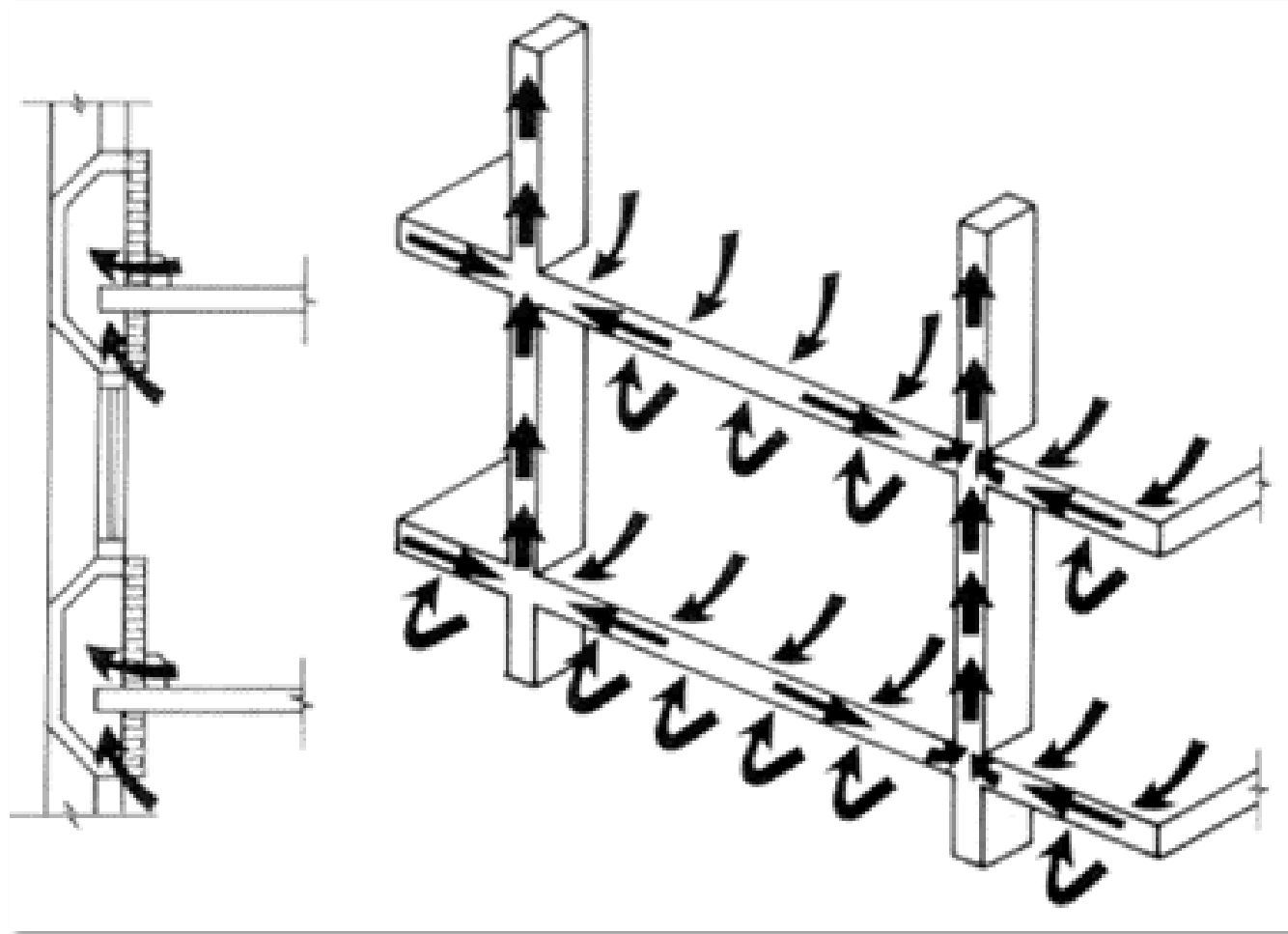

Block air paths!

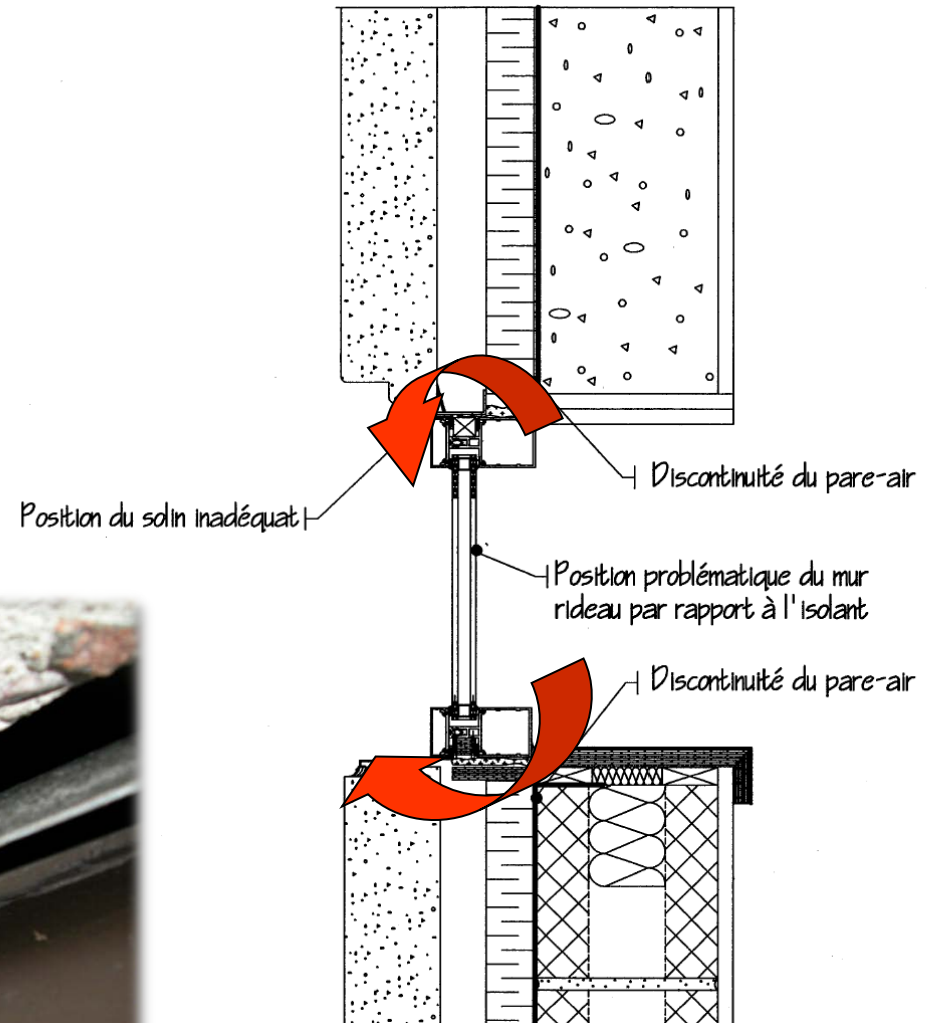

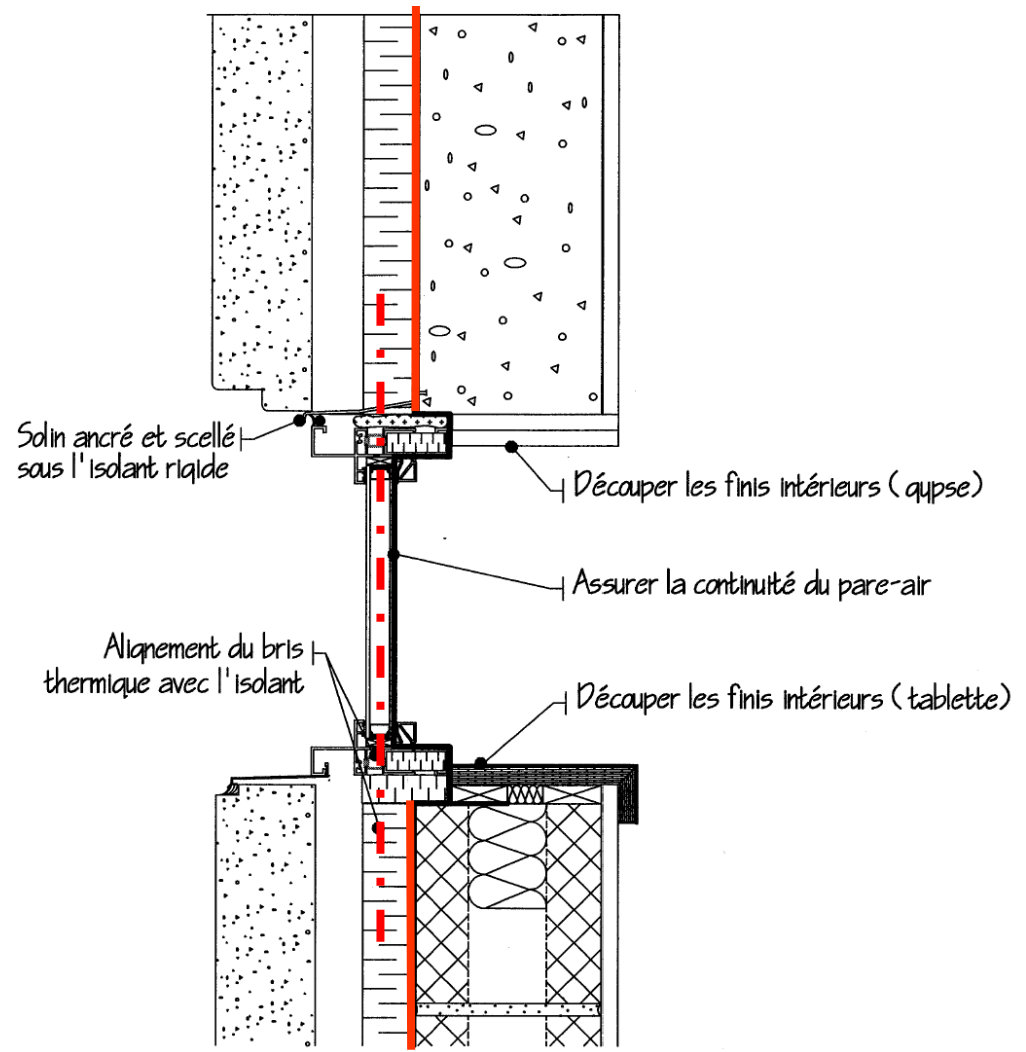

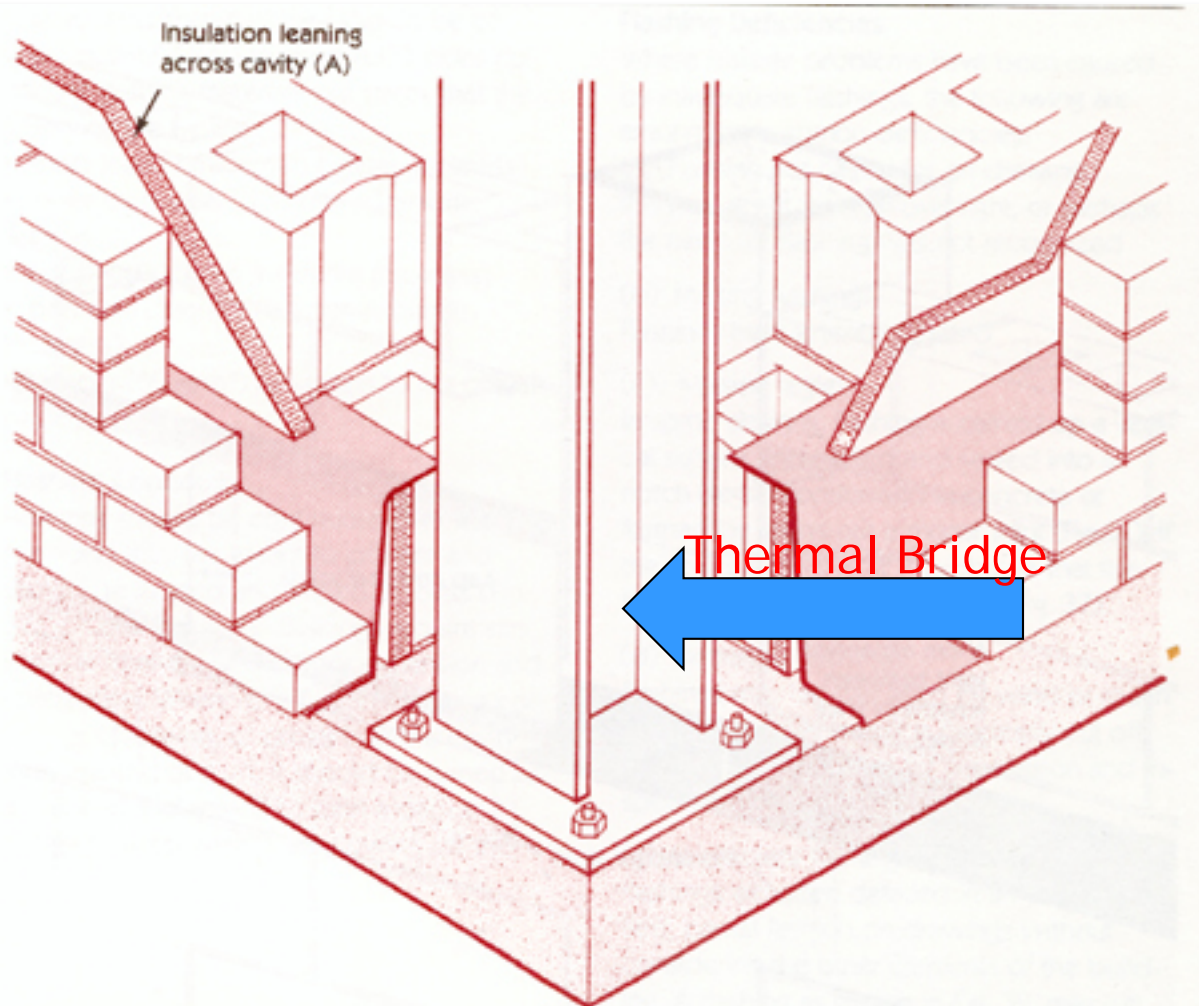
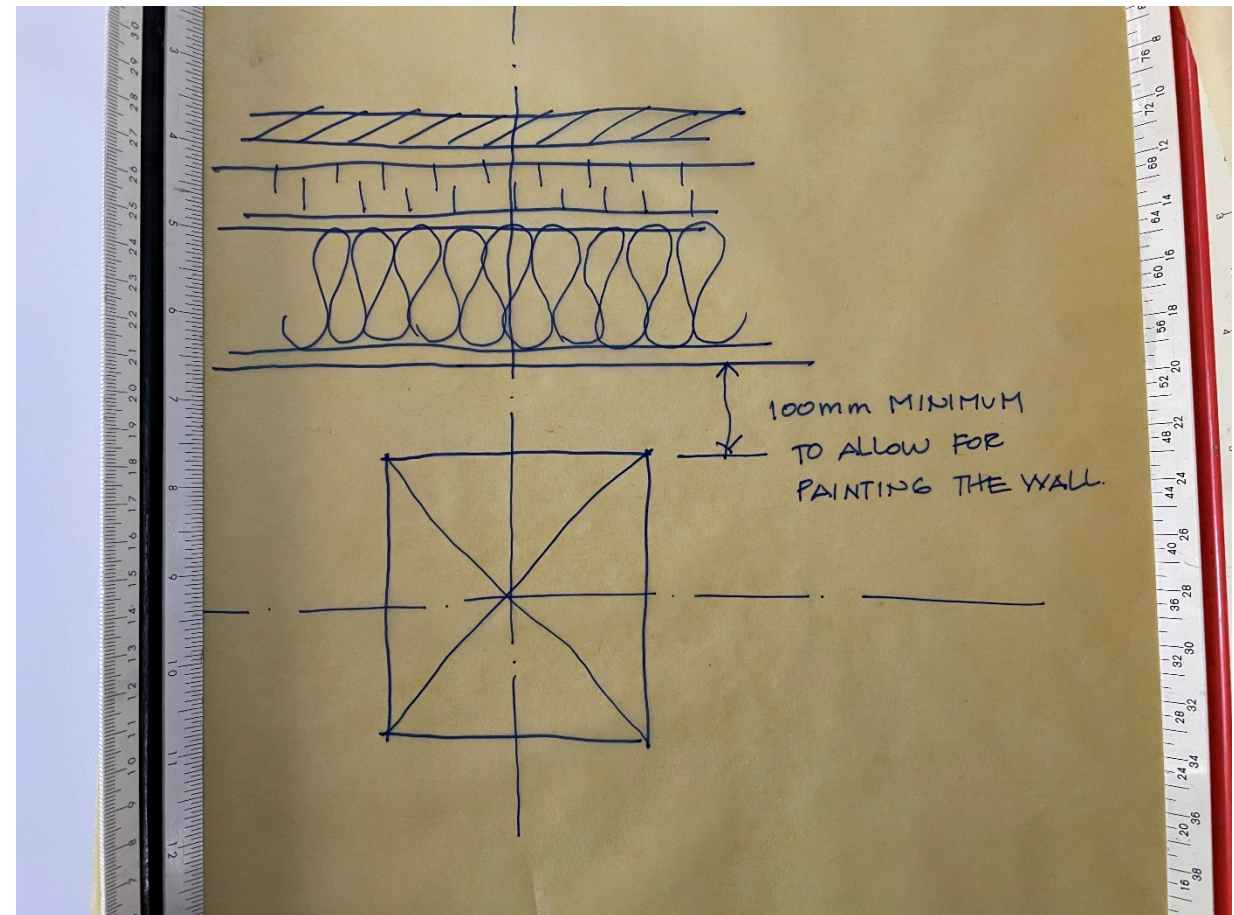
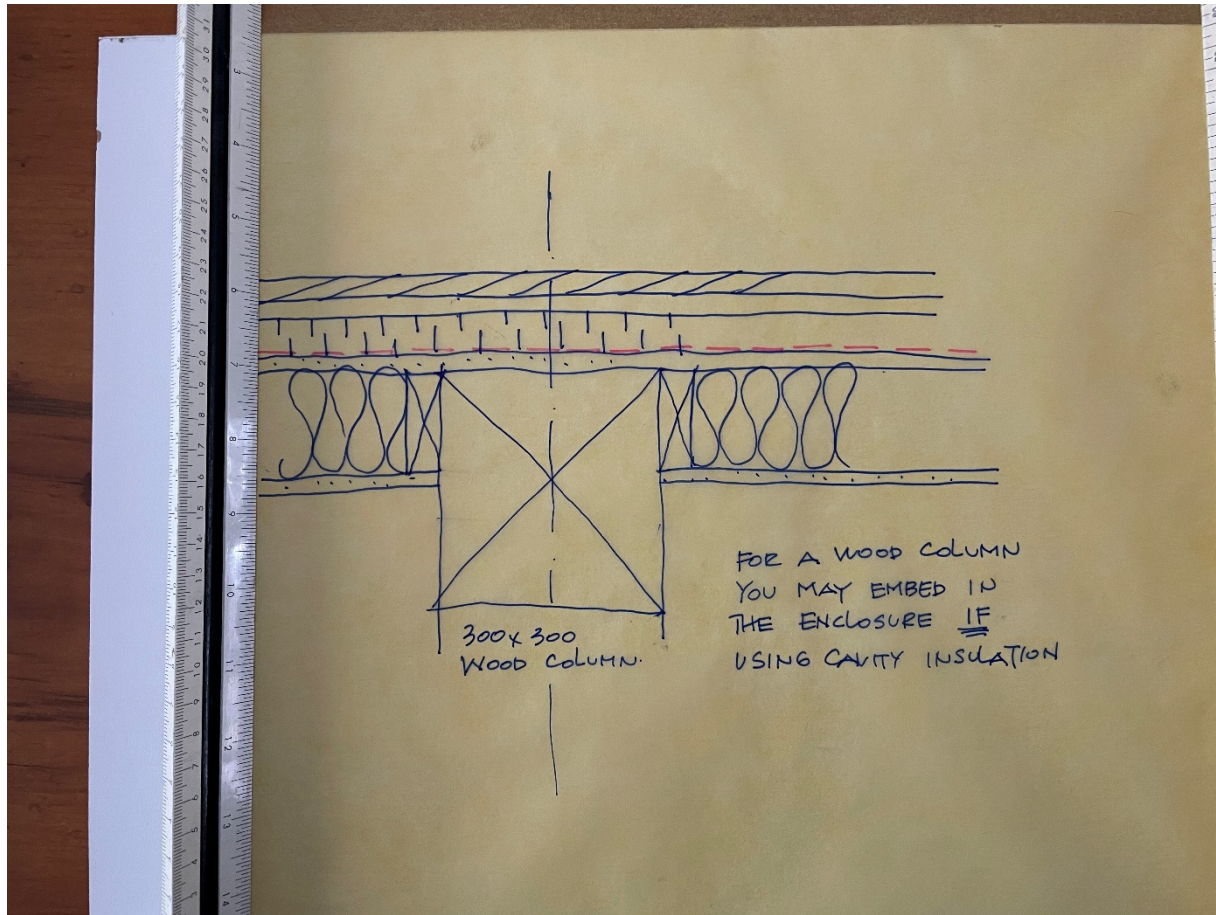

Fig. 39 It is easily visualized how leakage occurs where details like this are encountered.

It will be difficult to:

- flash around the column
- anchor the block
- obtain an air barrier
- maintain a cavity
- place the veneer
- maintain a continuous thermal barrier (Ref. 16).

It is always necessary to visualize details in 3-D in order to properly understand and design a continuous air barrier system.



Remember that the envelope sits outside of the column line, so can easily be clear of the air barrier membrane.

Air barrier design criteria: *Durability*:

Durability

The airtightness system must outlast the building itself. For this to happen, the materials used must have a proven track record or the material should be positioned in such a way that it is accessible for inspection and maintenance.

Durability is not an intrinsic property of a material but depends largely on how a material reacts to a specific environment such as moisture, temperature, ultra-violet radiation, and to the presence of other materials (incompatibility).

Products

Early methods relied solely on polyethylene film to act as a combined air and vapour barrier.

This did not prove highly effective as the poly was not durable enough.

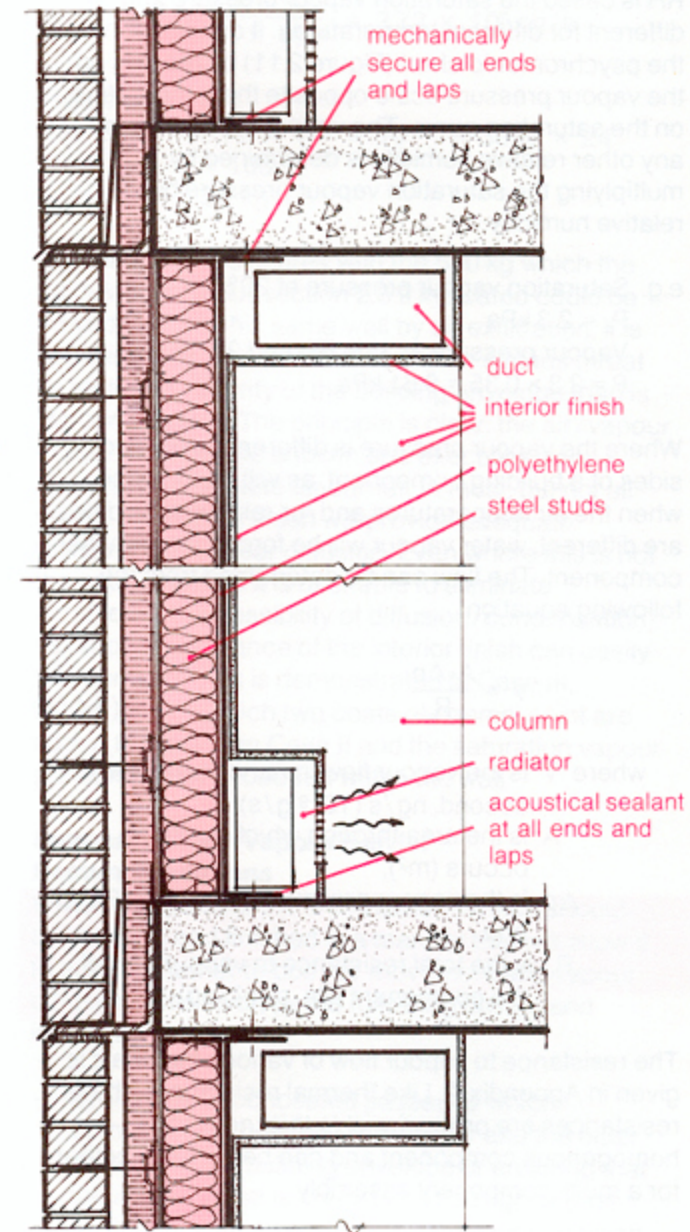
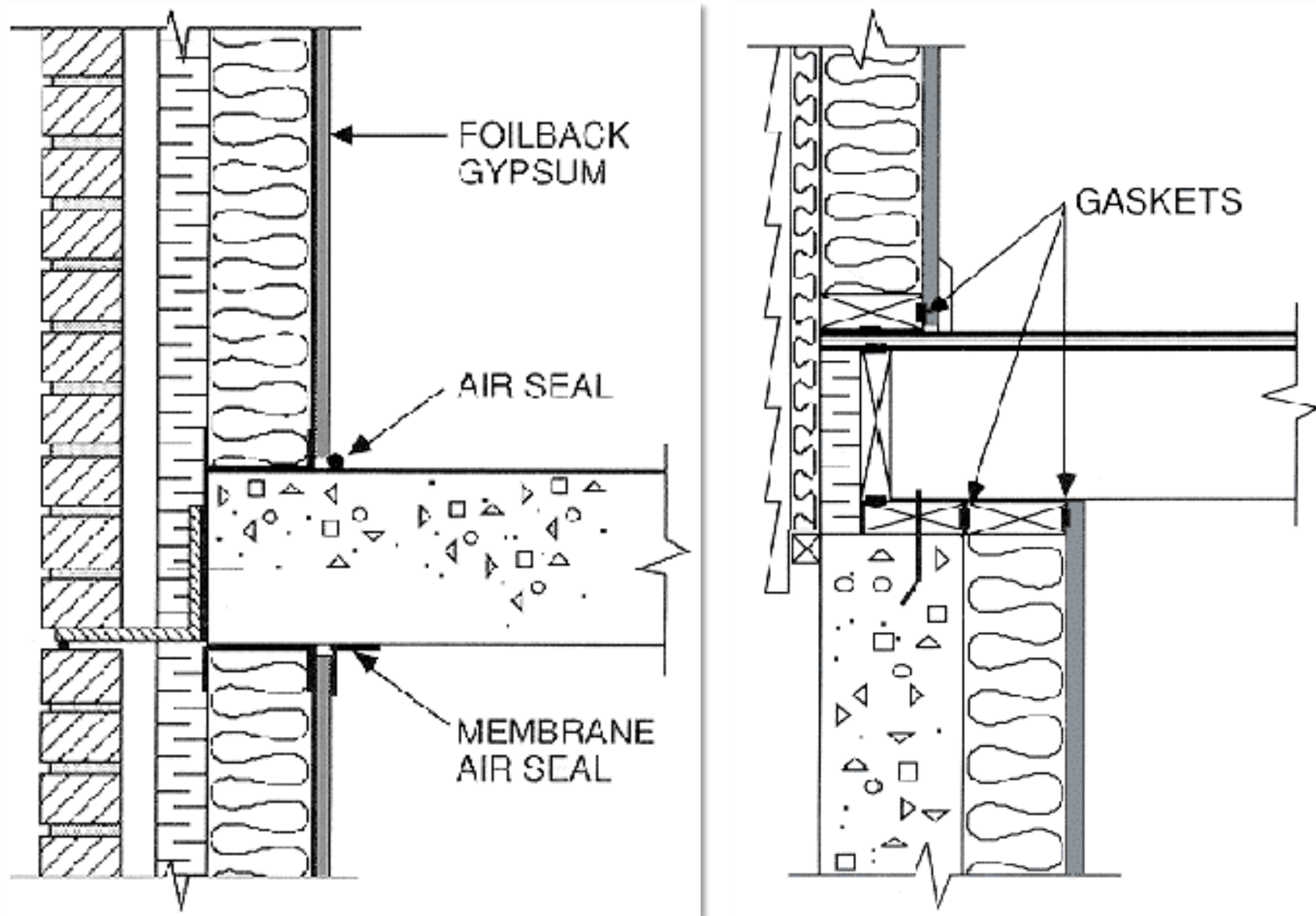
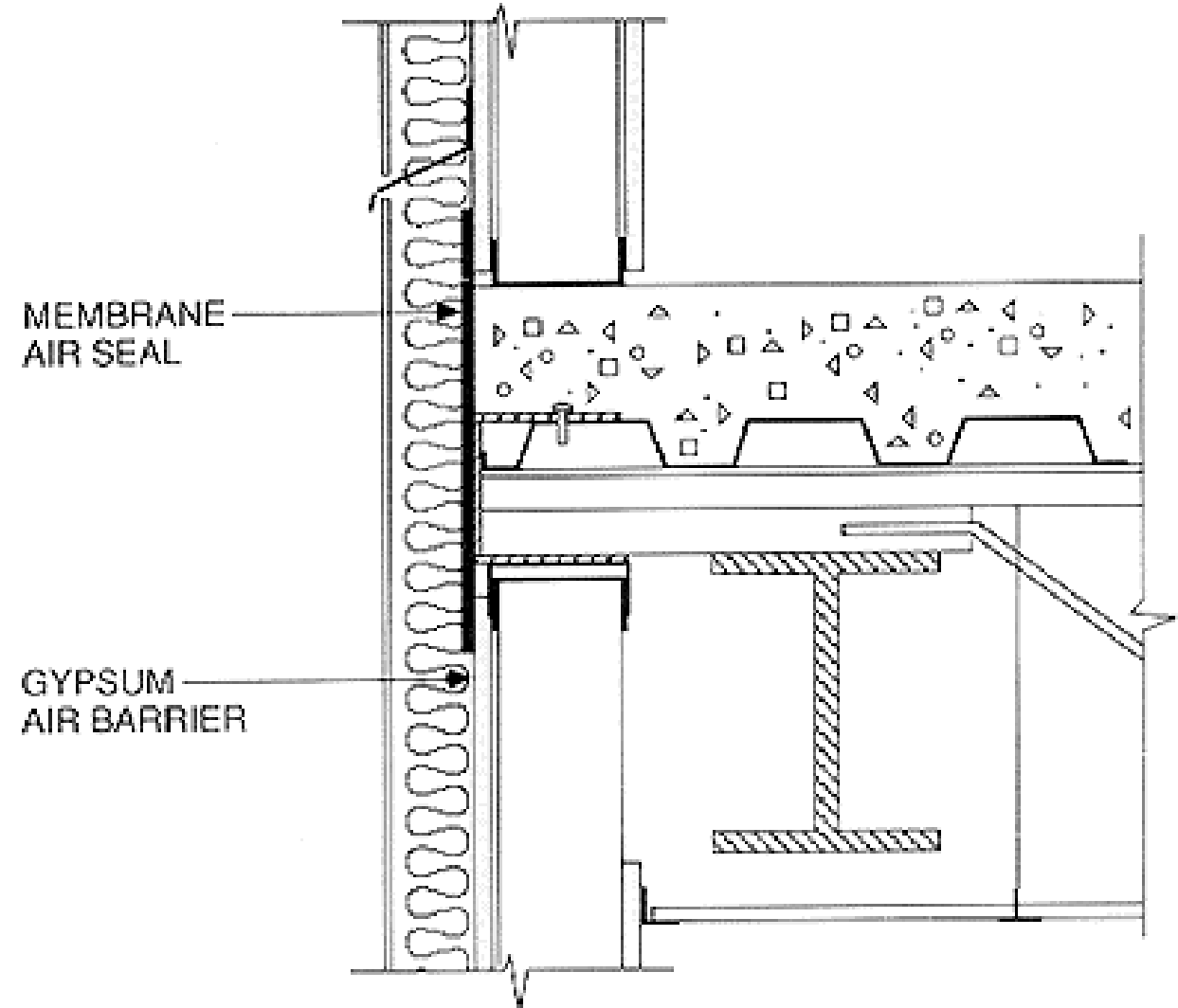
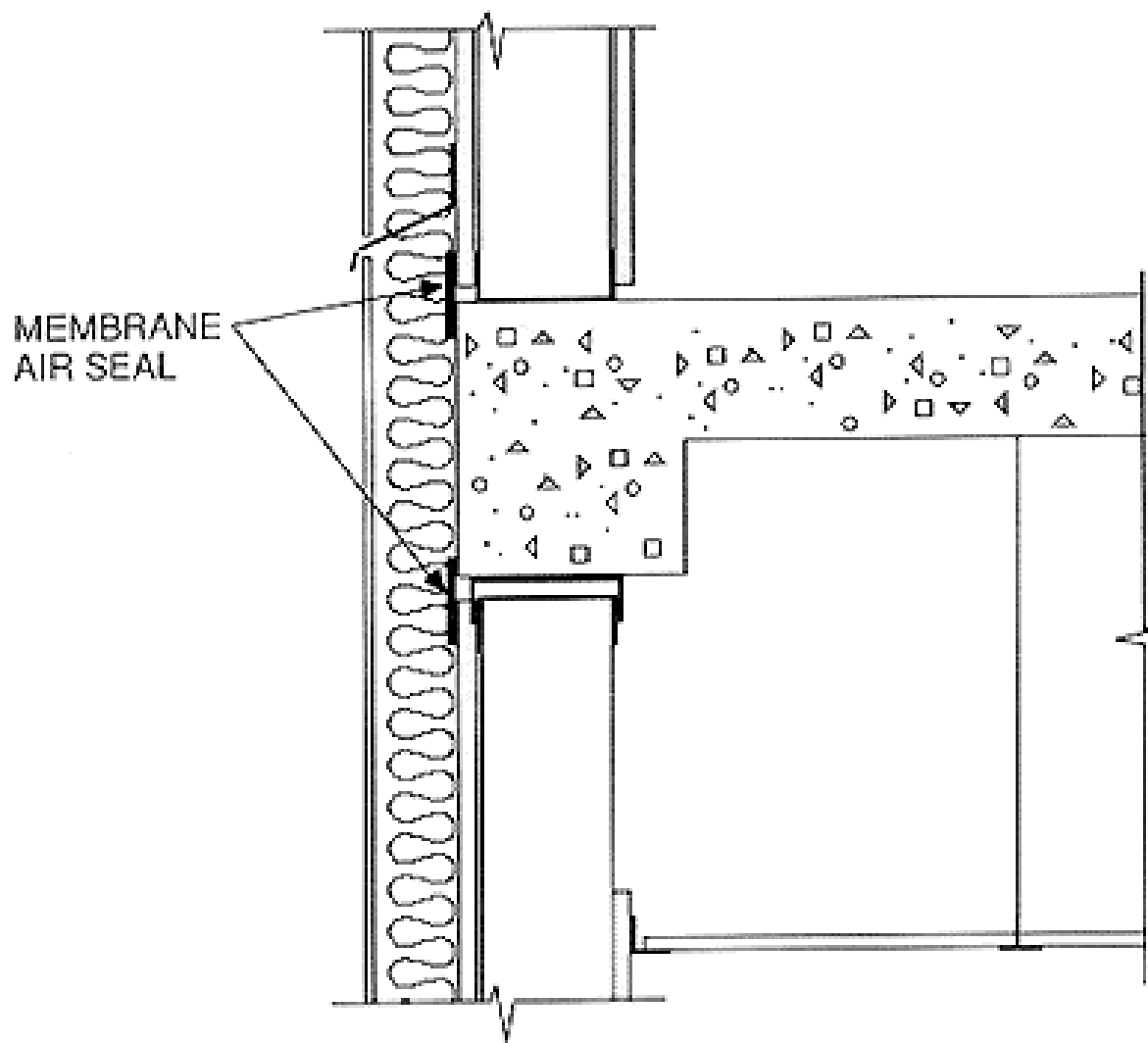

Figure 2.16 Polyethylene Film Used as Air/Vapour Barrier

The exposed drywall approach replaced reliance on polyethylene:



Drywall as Air Barrier, must have joints sealed with gaskets or inspectable caulking



If drywall is not used as the air barrier, then membrane air seals (like those used in block construction) can be used on the warm side of the insulation.

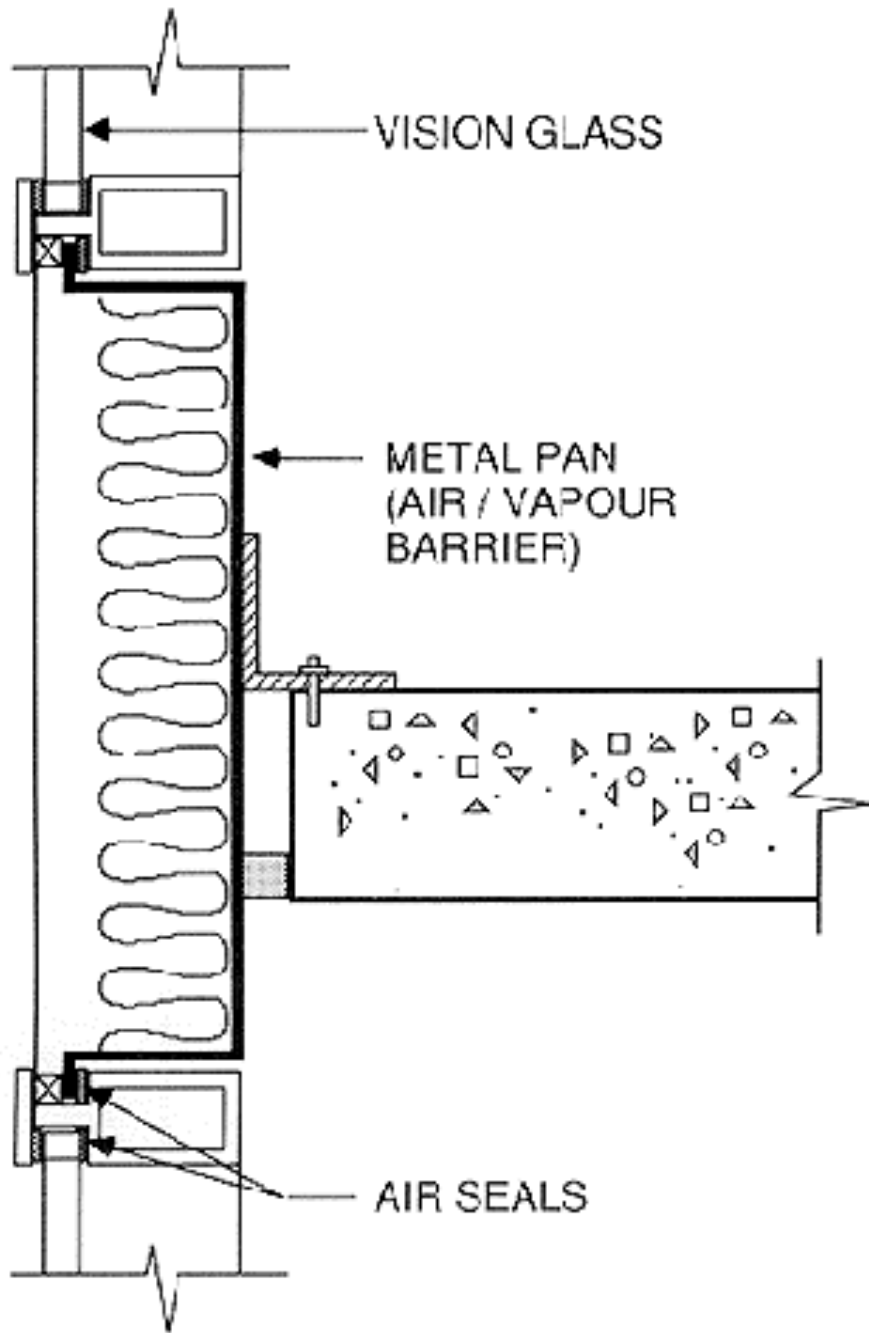

For curtain walls the metal backer pan can function as the air and vapour barrier, provided that seals are provided at the junction with the aluminum frame.

The glazing also acts as an air/vapour barrier.



Bitumenous products are also used as spray or roller applied air barrier systems.

These are considered a bit "old fashioned" at this point.



The technical name for the residential air barrier pictured here is spunbonded olefin

It is fixed to the envelope with mechanical fasteners.



Henry makes a peel and stick residential air barrier that is non bituminous but slightly more expensive than the white mechanically fastened variety.



Installation of Blueskin on Mars in downtown Toronto.



Some of the rolled membranes that are bitumen based products are adhered via a torched (heat applied) application.



Peel and stick barriers require the application of a roll on base compound to seal the concrete block surface and help adhesion.



Base flashing also comes in peel and stick product types, but they are usually heavier in quality.



A roller is used on peel and stick membranes to smooth out the product and help to seal edges.



Other devices can be used to flatten out any bubbles or wrinkles in the material.



Care must be taken to make sure that material is added at joints for overlap so to ensure that no air/water leaks.



The wall product is lapped over the base flashing to ensure water runoff. The material is cut where it meets masonry ties. These junctions must be resealed to prevent air leakage.



Each subsequent layer of material is lapped over the previous to prevent water from entering from the cavity, and to make for a tight air barrier preventing air leakage from the inside.



Be sure to properly join and flash openings to prevent leakage.

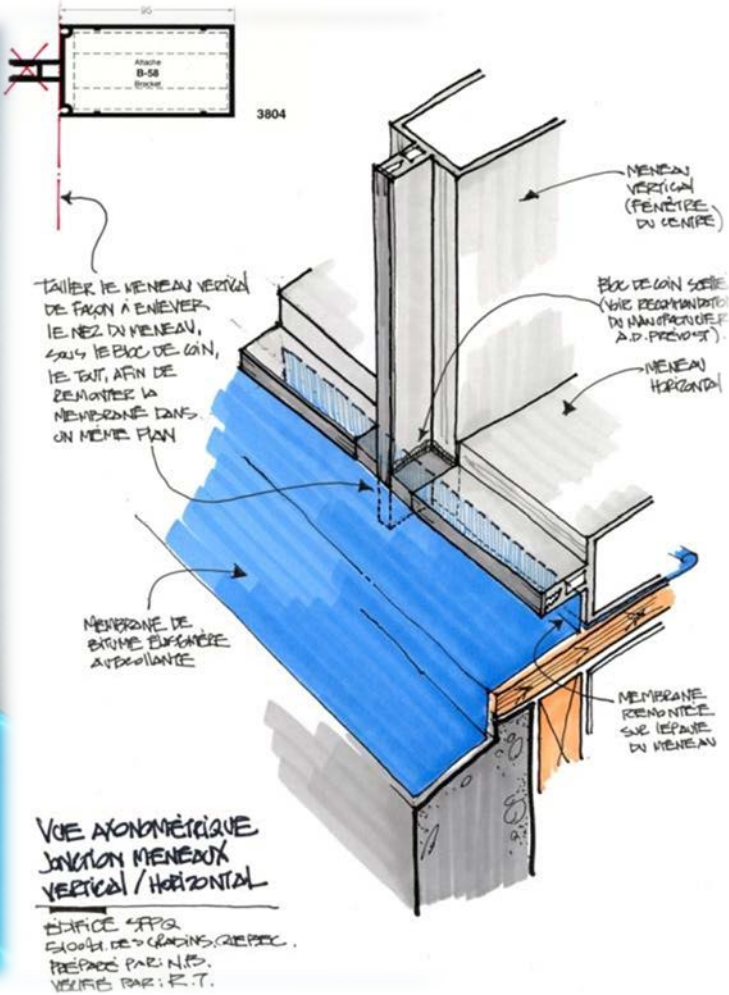

Air barrier membrane also comes in trowel applied applications.





Trowel applied membranes can also be used.

The trowel applied material can be used in conjunction with stick on membranes to seal around form tie cuts.

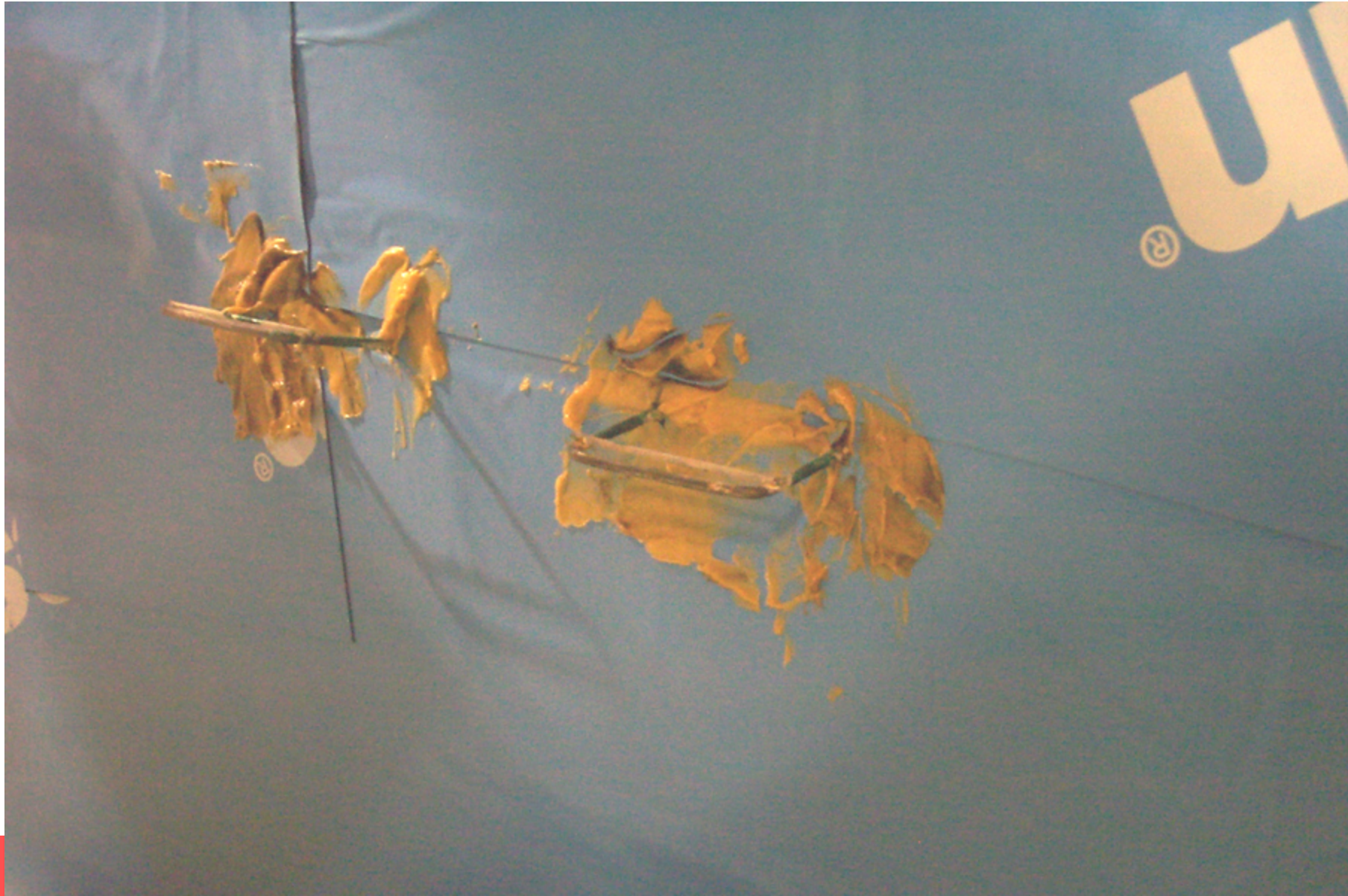



Polyurethane foam insulation (PUFI) can also be used on masonry and other base materials as a combined insulation and air barrier system.



Tohu, permanent circus bigtop, Montreal

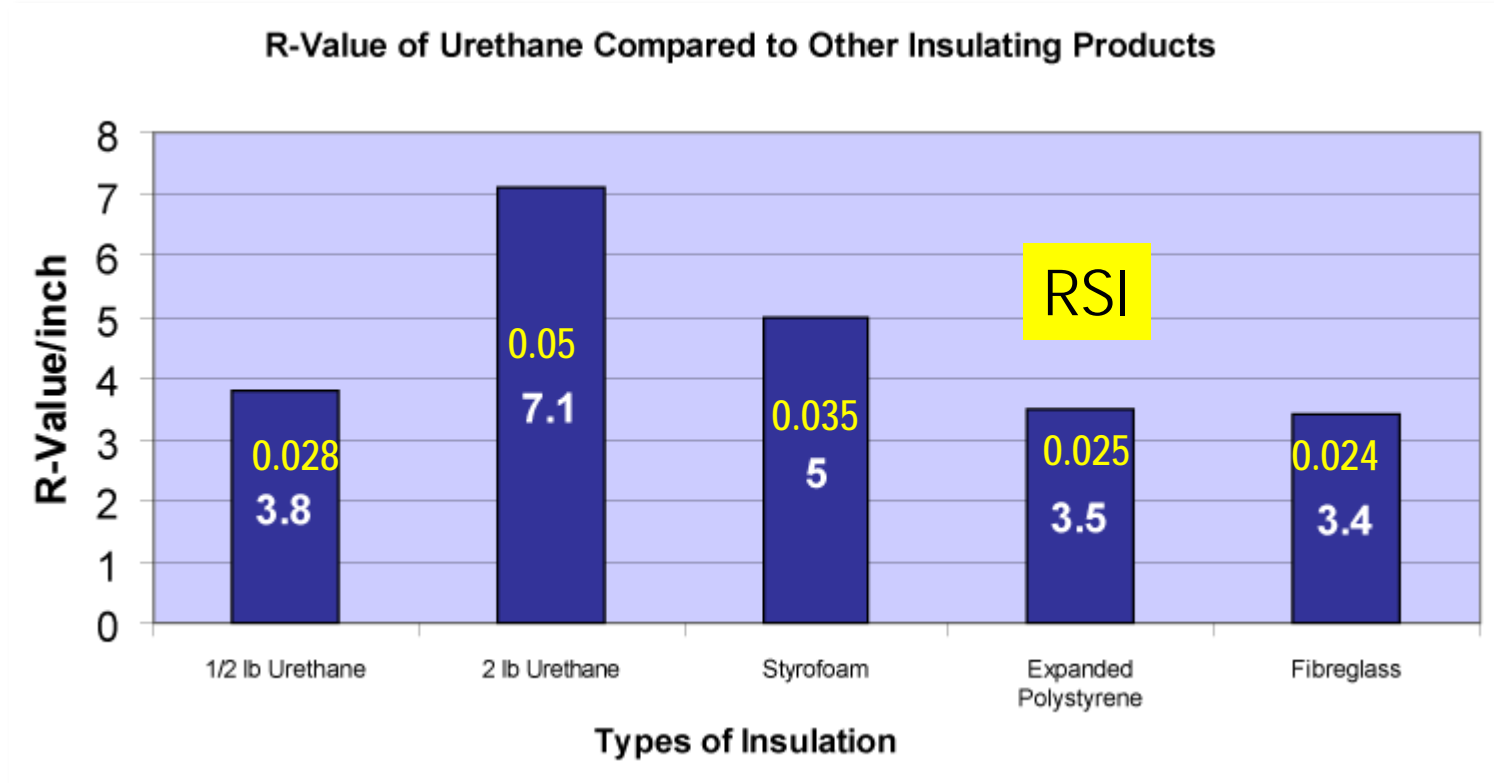

Urethane products vary by density of application

Examples of air and vapour
barrier systems:

You need to understand how air will flow via both diffuse and channel/orifice methods in order to begin to create the strategy for your air barrier detailing.

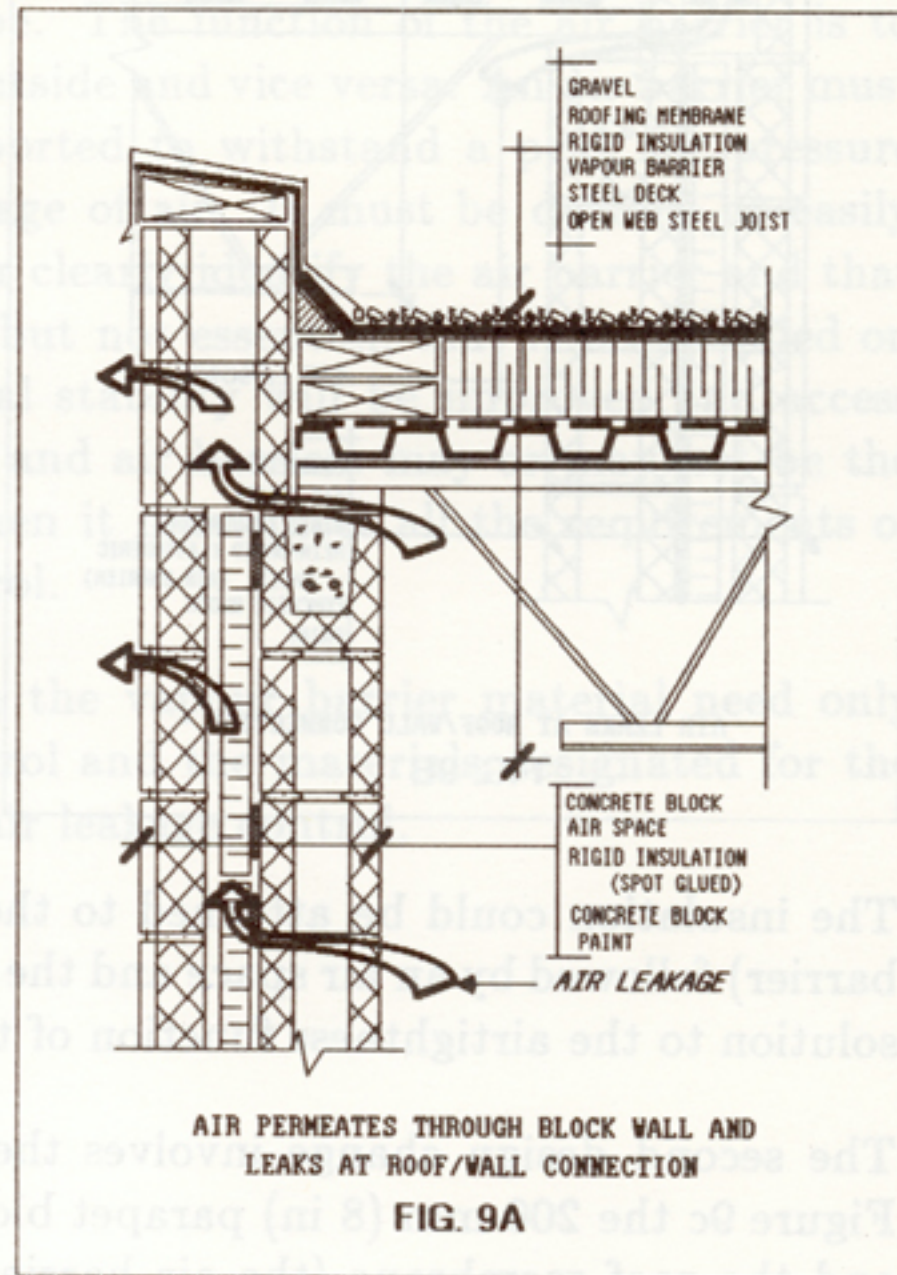

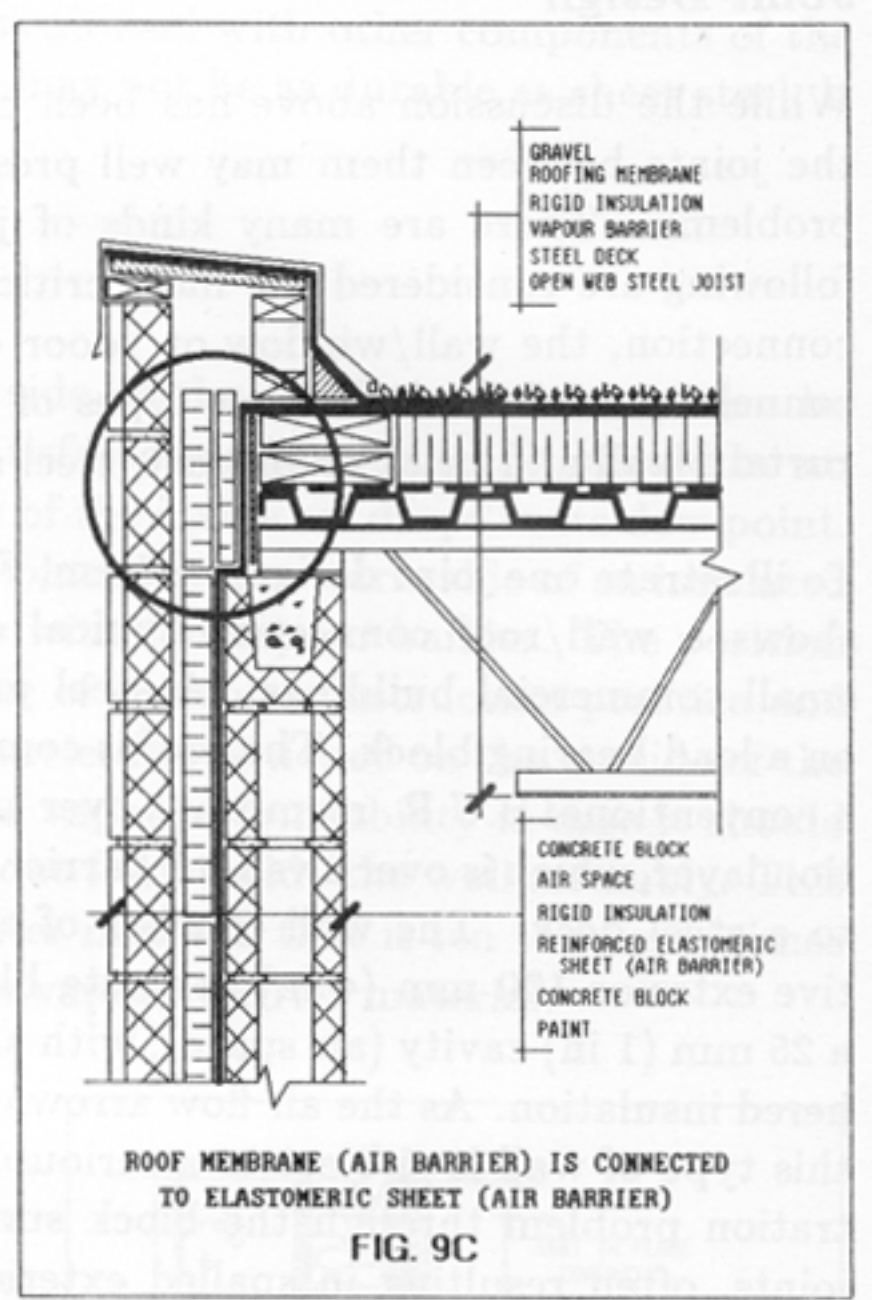
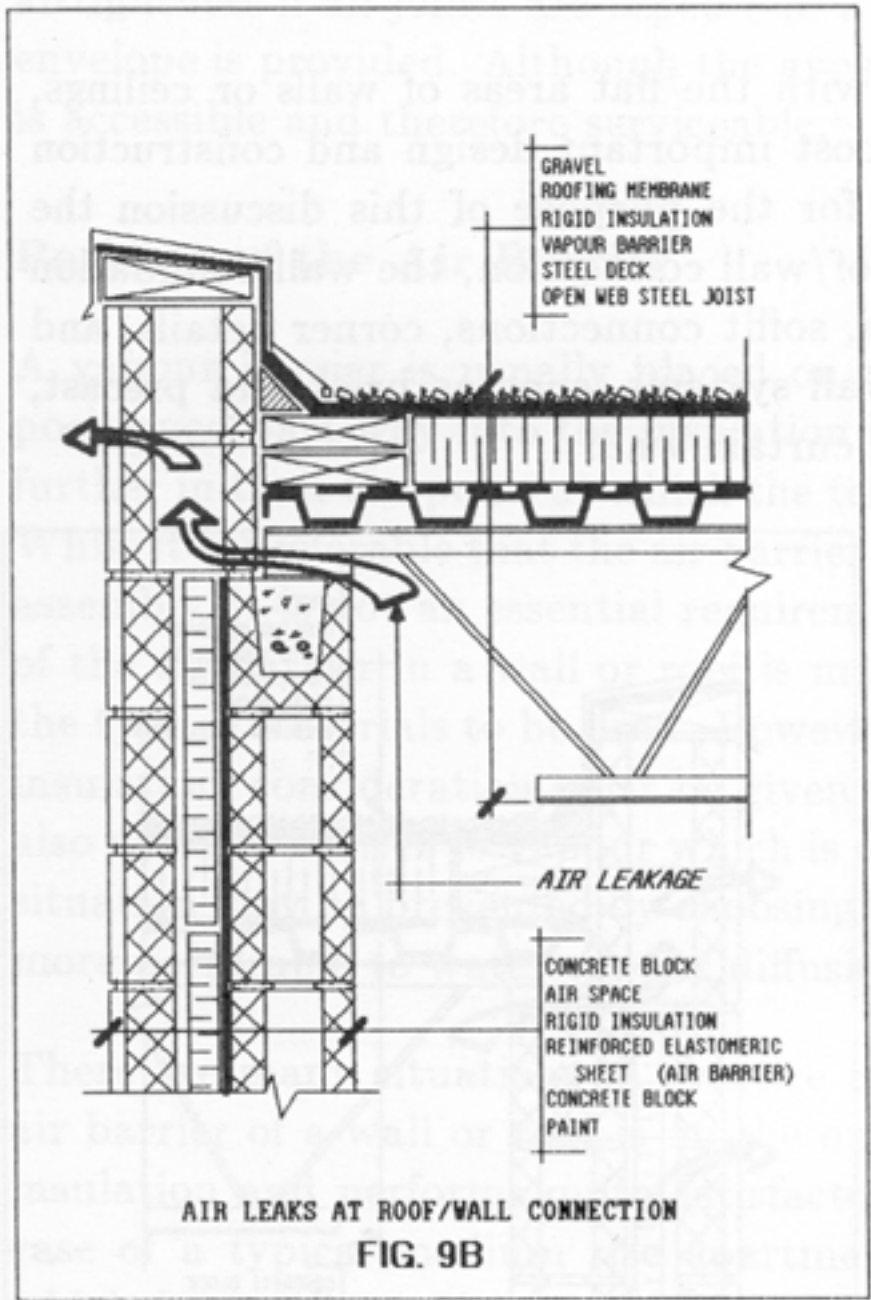

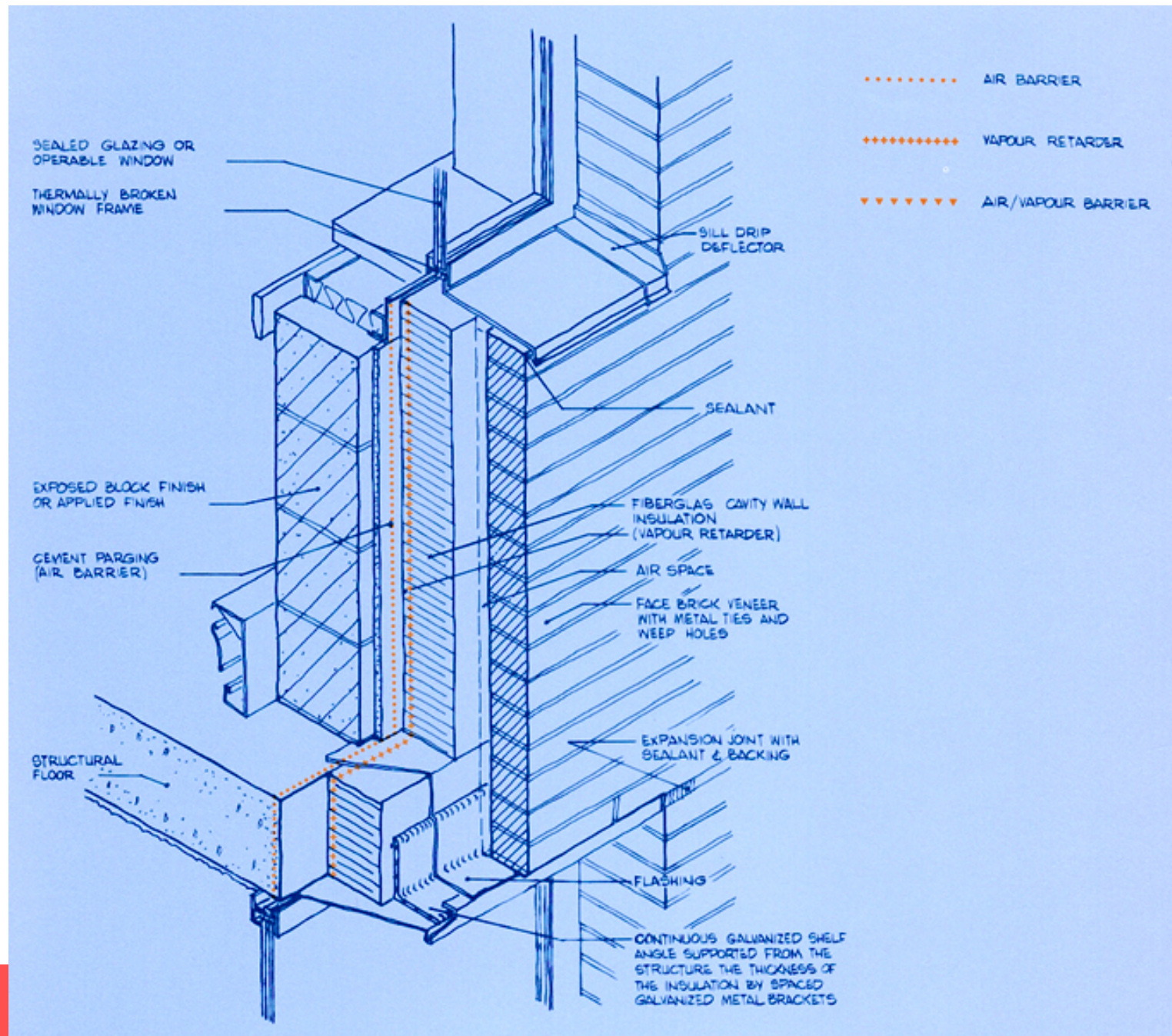

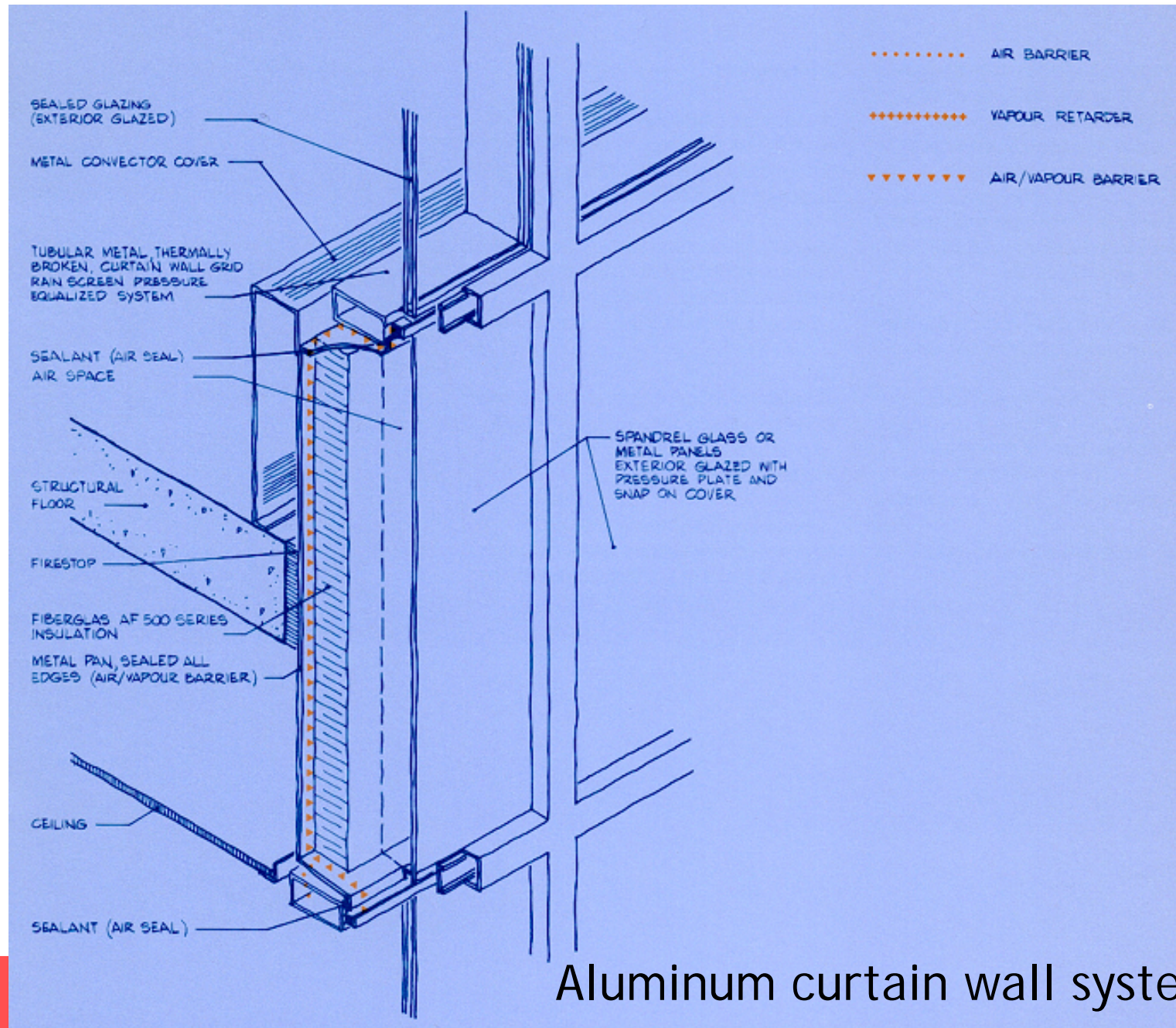

Aluminum curtain wall systems



In curtain wall the glass can be acting as the air/vapour barrier, or in the case of solid looking walls, the metal backer panel behind the insulation.



Industrial metal cladding systems

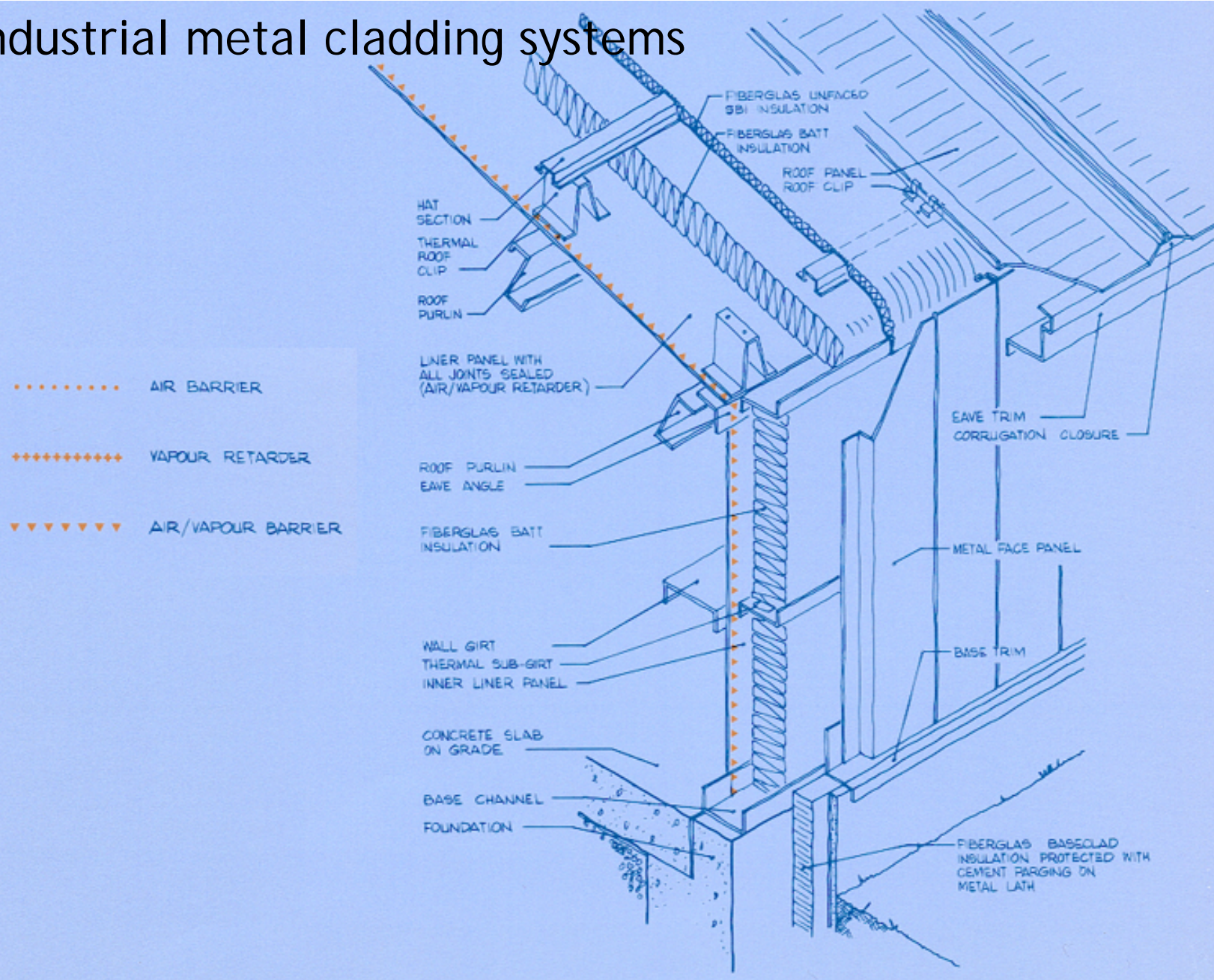

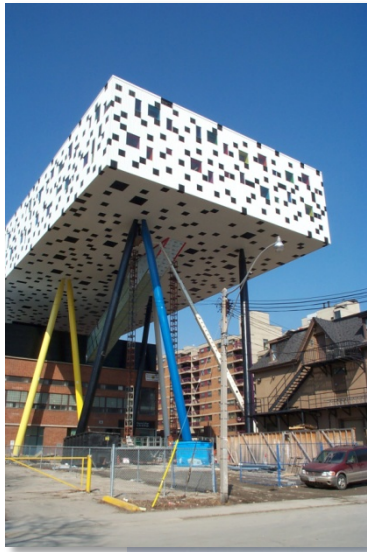

Ontario College of Art and Design





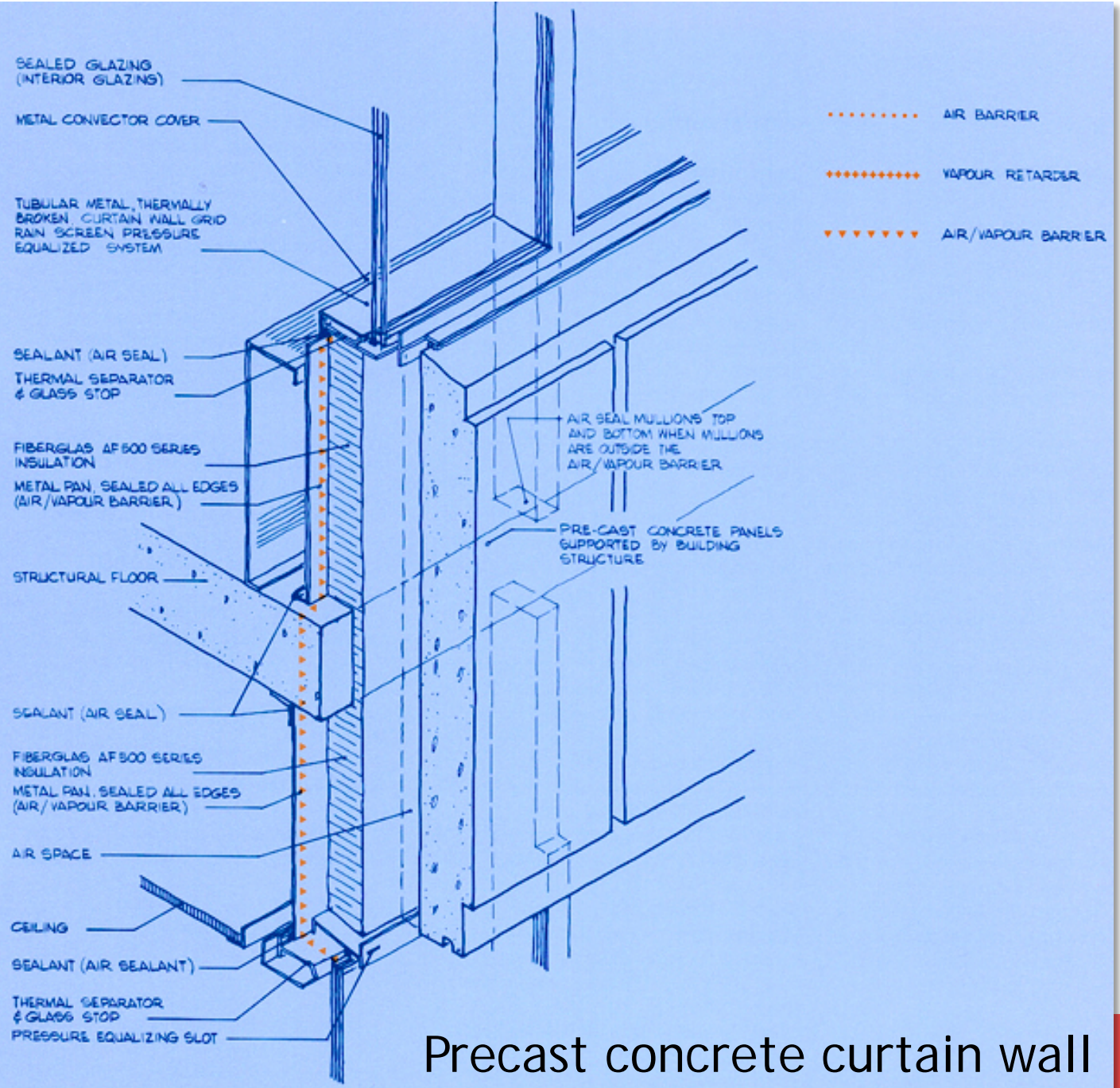

Precast concrete curtain wall

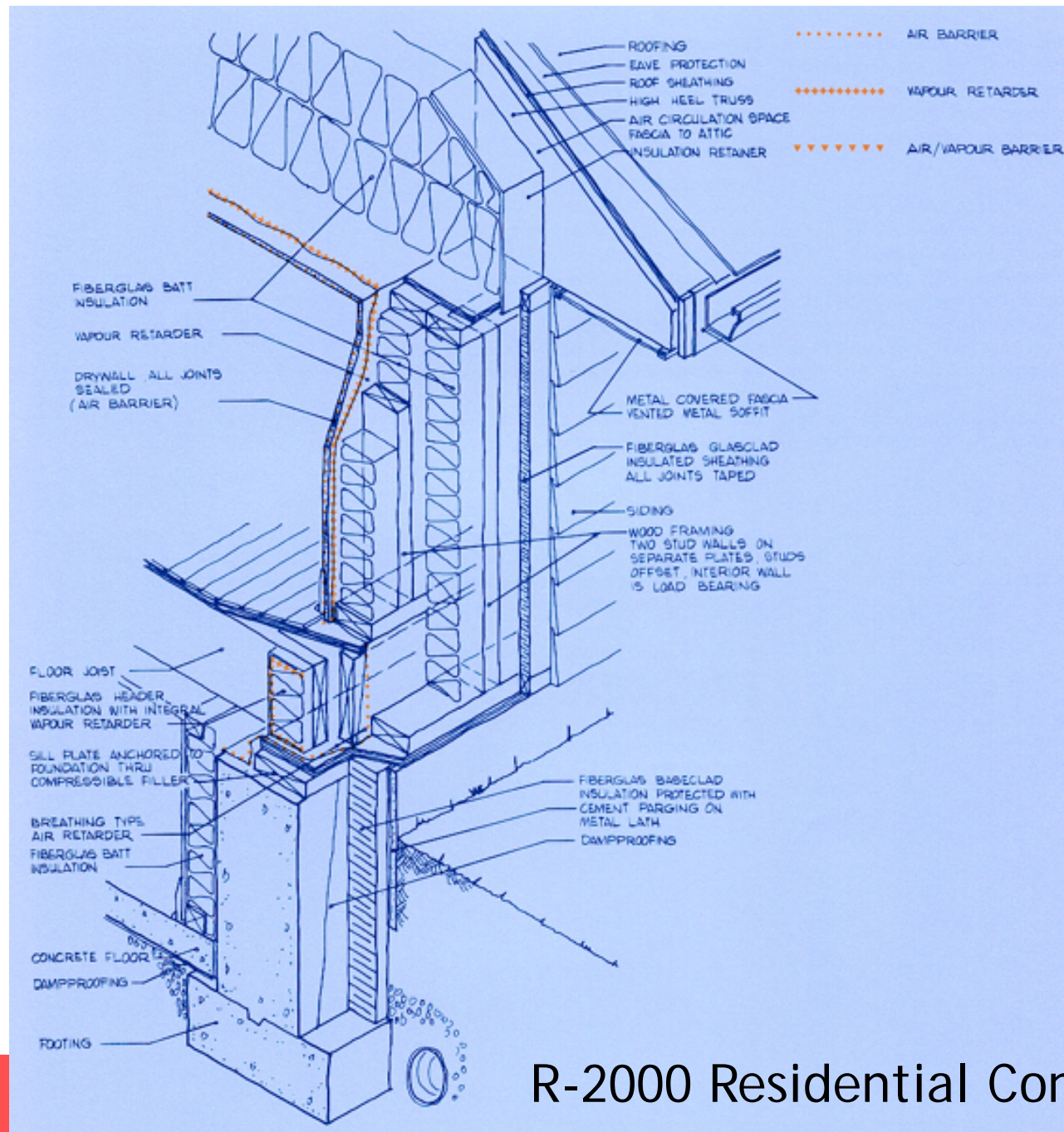

R-2000 Residential Construction

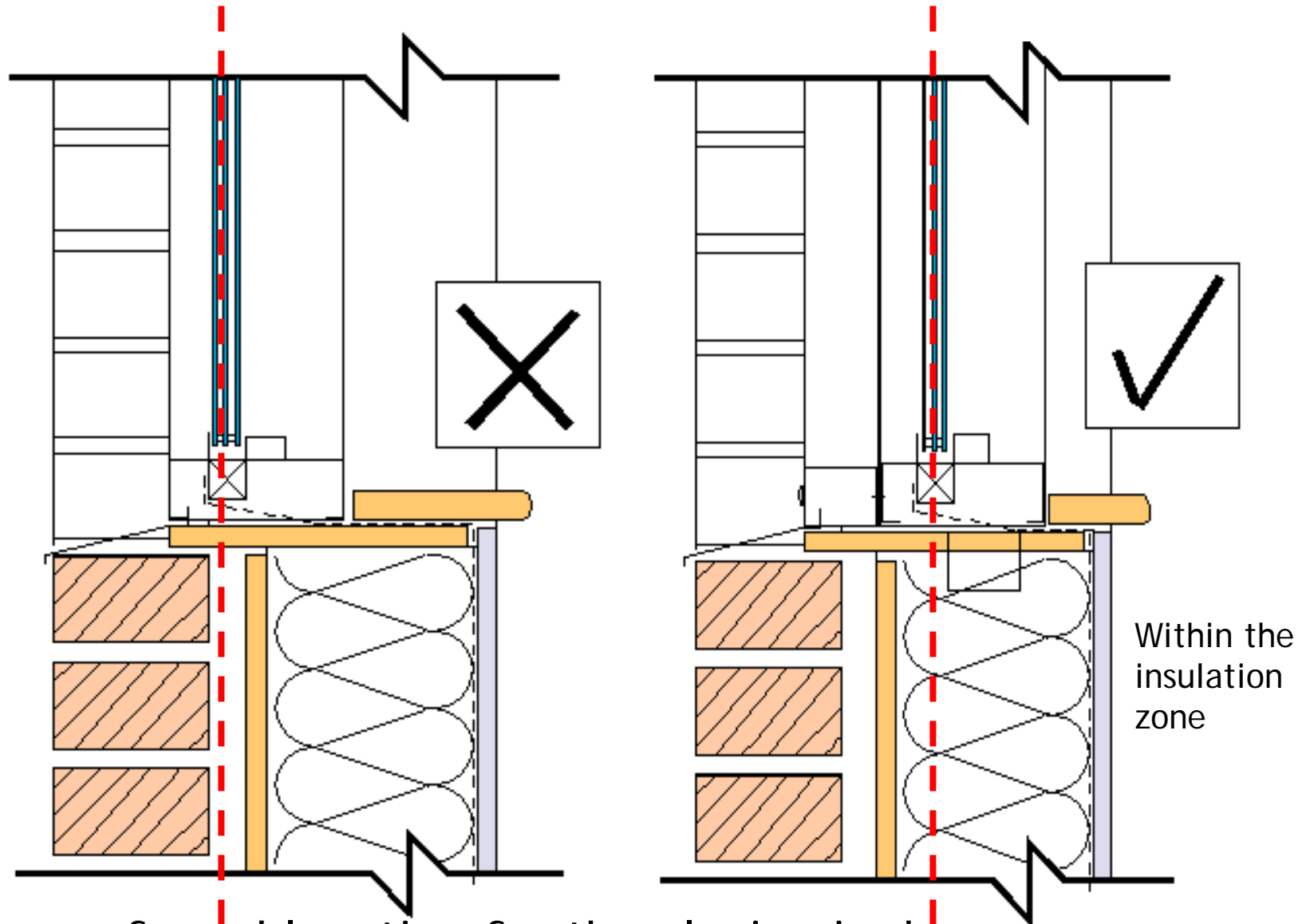

The preferred location for the glazing is shown.