



A

ARCHITECTURAL PRECAST CONCRETE WALLS

BEST PRACTICE GUIDE



HOME TO CANADIANS
Canada



BEST PRACTICE GUIDE

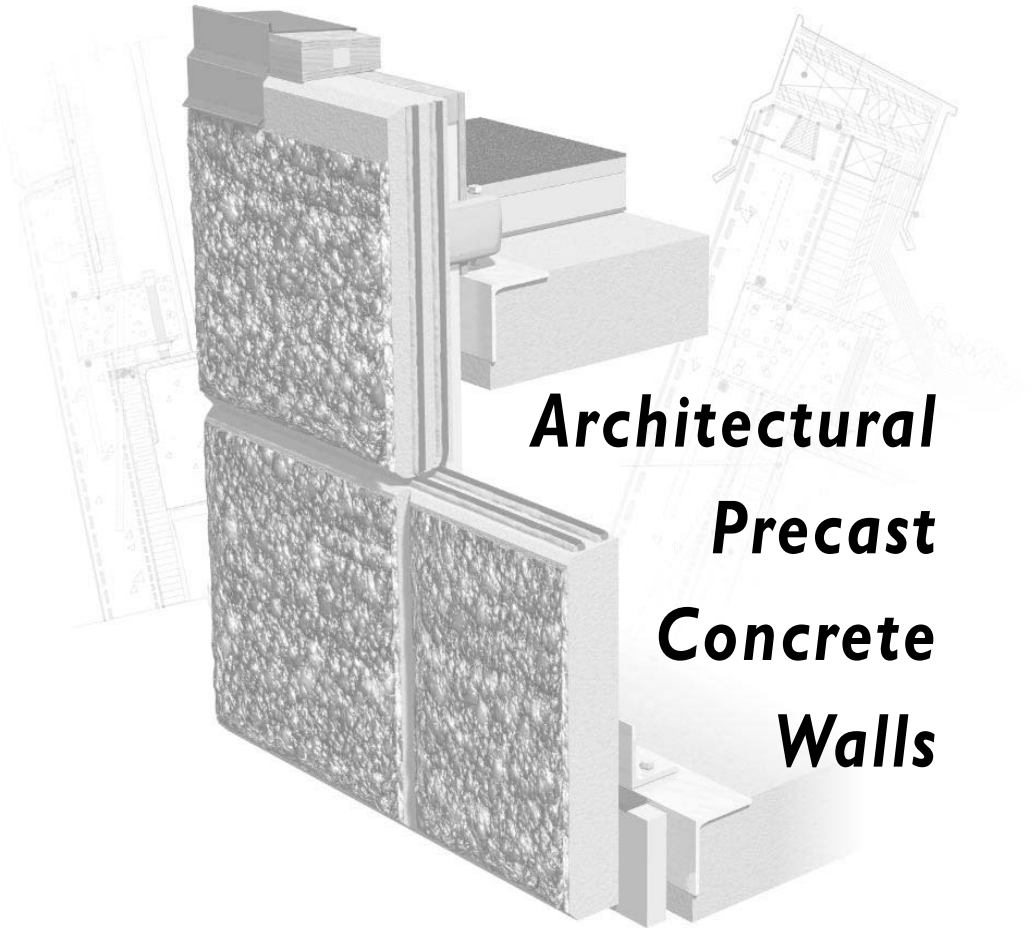

Architectural Precast Concrete Walls

CMHC offers a wide range of housing-related information. For details, call 1 800 668-2642 or visit our home page at www.cmhc.ca

Cette publication est aussi disponible en français sous le titre: Guide des règles de l'art – murs en béton architectural préfabriqué 62985.



Public Works and
Government Services
Canada

Travaux publics et
Services gouvernementaux
Canada



Canada

CMHC—HOME TO CANADIANS

Canada Mortgage and Housing Corporation (CMHC) is the Government of Canada's national housing agency. We help Canadians gain access to a wide choice of quality, affordable homes.

Our mortgage loan insurance program has helped many Canadians realize their dream of owning a home. We provide financial assistance to help Canadians most in need to gain access to safe, affordable housing. Through our research, we encourage innovation in housing design and technology, community planning, housing choice and finance. We also work in partnership with industry and other Team Canada members to sell Canadian products and expertise in foreign markets, thereby creating jobs for Canadians here at home.

We offer a wide variety of information products to consumers and the housing industry to help them make informed purchasing and business decisions. With Canada's most comprehensive selection of information about housing and homes, we are Canada's largest publisher of housing information.

In everything that we do, we are helping to improve the quality of life for Canadians in communities across this country. We are helping Canadians live in safe, secure homes. CMHC is home to Canadians.

Canadians can easily access our information through retail outlets and CMHC's regional offices.

You can also reach us by phone at 1 800 668-2642
(outside Canada call (613) 748-2003)

By fax at 1 800 245-9274
(outside Canada (613) 748-2016)

To reach us online, visit our home page at www.cmhc.ca

This Best Practice Guide is a joint venture of Canada Mortgage and Housing Corporation and Public Works Government Services Canada in collaboration with the Canadian Precast/Prestressed Concrete Institute.

CPCI encourages the use of the Best Practice Guide for Architectural Precast Concrete Walls as a means of improving overall construction quality. The drawings and text will contribute to a better understanding of building science issues that will assist designers and builders construct envelopes that are reliable, durable and economic.

National Library of Canada cataloguing in publication data

Main entry under title: Architectural precast concrete walls (Best practice guide)

Issued also in French under title: Murs en béton préfabriqué architectural.

Includes a CD-ROM with CAD drawings.

Includes bibliographical references.

ISBN 0-660-18896-1

Cat. no. NH15-132/5-2002E

- I. Concrete walls – Design and construction.
2. Walls – Design and construction.
3. Precast concrete construction.
- I. Canada Mortgage and Housing Corporation.
- II. Series.

TH2245.A72 2002

690'.12

C2002-980260-1

© 2002, Canada Mortgage and Housing Corporation. All rights reserved. No portion of this book may be reproduced, stored in a retrieval system or transmitted in any form or by any means, mechanical, electronic, photocopying, recording or otherwise without the prior written permission of Canada Mortgage and Housing Corporation. Without limiting the generality of the foregoing no portion of this book may be translated from English into any other language without the prior written permission of Canada Mortgage and Housing Corporation.

Printed in Canada
Produced by CMHC

CMHC-CANADA'S LEADING SOURCE OF HOUSING INFORMATION

Canada Mortgage and Housing Corporation is committed to housing quality, affordability and choice for Canadians. For more than 50 years CMHC has developed new ways to help Canadians finance home purchases, fostered innovation in housing design and technology, and provided social housing programs to help those most in need. CMHC has also played a major role in the development of Canada's housing industry. We've recently become the industry's export partner, supporting and promoting housing exports in foreign markets.

CMHC is Canada's largest publisher of housing information, in both print and electronic formats. Today, CMHC offers Canada's most comprehensive selection of publications, videos, software, data and analysis. The Canadian housing industry looks to CMHC for reliable and objective housing information on construction techniques, housing design, business skills, new technologies and market trends.

Canadians have come to rely on CMHC for advice and information on buying a home, home renovation, Healthy Housing, design and adaptation and home security. We offer easy access to our information through a 1 800 number, Web site, cross country regional locations and retail outlets.

CMHC information:

Tel: 1 800 668-2642 (outside Canada, call 613 748-2003)

Fax: 613 748-4069

Web site: www.cmhc.ca

FOREWORD

The information contained in this publication represents current research results available to CMHC, and has been reviewed by a wide spectrum of experts in the housing industry. Readers are advised to evaluate the information, materials and techniques cautiously for themselves and to consult appropriate professional resources to determine whether information, materials and techniques are suitable in their case. The drawings and text are intended as general practice guides only. Project and site-specific factors of climate, cost, aesthetics, and so on must be taken into consideration.

STEERING COMMITTEE FOR THE BEST PRACTICE GUIDE:

David Bryden, arch.
Bryden, Martel, Architects Inc.
1066 Somerset W,
Ottawa, Ontario
K1Y 4T3

John Fowler, P. Eng.
CPCI
100 - 196 Bronson Avenue,
Ottawa, Ontario
K1R 6H4

Malcolm Hachborn, P.Eng.
RES Precast Inc.
3450 Thomas Street
The 400 Industrial Park
Innisfil, Ontario
L9S 3W6

Luis de Miguel, arch.
CMHC
700 Montreal Rd.
Ottawa, Ontario
K1A 0P7

Allan Wiseman, P. Eng.
PWGSC
Portage III, 8B1
11 Laurier Street
Hull, Quebec
K1A 0S5

ACKNOWLEDGEMENT

This Guide was prepared by Morrison Hershfield Ltd. and wishes to acknowledge the substantial contribution made by the steering committee.

TABLE OF CONTENTS

CHAPTER 1: INTRODUCTION

- Background 2
- The Best Practice Guide 3

CHAPTER 2: CHARACTERISTICS OF ARCHITECTURAL PRECAST CONCRETE

- General 6
- Materials and Finishes 6
- Manufacturing Considerations 14
- Transportation and Erection 16
- Anchorage Connections 18

CHAPTER 3: ASSEMBLIES

- Panel Types 22
- Panel Layout 25
- Precast Panel Edge Design 28
- Interface with other Components 34
- Building Frame 37

CHAPTER 4: DETAILS

- Performance Requirements 40
- Details Overview 45

CHAPTER 5: SPECIFICATIONS

- General 94
- Sample Specification 94

CHAPTER 6: QUALITY ASSURANCE

- Overview 108
- The Shop Drawing Review Process 109
- Implementation of Design 109

CHAPTER 7: MAINTENANCE AND RENEWAL

- Overview 112
- Maintenance Planning 112
- Renewal Planning 112

REFERENCES 114

GLOSSARY 115

LIST OF DETAILS

1.	Conventional Panel-Bottom Bearing and Lateral Foundation Connection	46
2.	Conventional Panel-Lateral Foundation Connection	48
3.	Conventional Panel-Soffit Connection	50
4.	Conventional Panel-Slab Bearing Connection	52
5.	Conventional Panel-Top Hung Parapet Connection	54
6.	Conventional Panel-Lateral Connection at Parapet	56
7.	Conventional Panel-Window Head / Sill Connection	58
8.	Conventional Panel-Window Jamb Connection	60
9.	Conventional Panel-Junction w/Curtain Wall	62
10.	Conventional Panel-Junction w/Stucco	64
11.	Conventional Panel-Junction w/Brick Veneer	66
12.	Conventional Panel-Column Cover	68
13.	Sandwich Panel-Bottom Bearing Foundation Connection	70
14.	Sandwich Panel-Suspended Soffit-Lateral Soffit Connection	72
15.	Sandwich Panel w/Rainscreen-Slab Bearing Floor Connection	74
16.	Sandwich Panel-Roof / Wall Junction	76
17.	Sandwich Panel-Alternate Roof / Wall Junction	78
18.	Sandwich Panel w/Rainscreen-Door Head Connection	80
19.	Sandwich Panel w/Rainscreen-Door Jamb Connection	82
20.	Sandwich Panel w/Rainscreen-Window Head / Sill Connection	84
21.	Sandwich Panel-Junction with Curtain Wall	86
22.	Sandwich Panel-Service Penetrations	88
23.	Sandwich Panel w/Rainscreen-Junction w/Brick Veneer	90

1

CHAPTER ONE

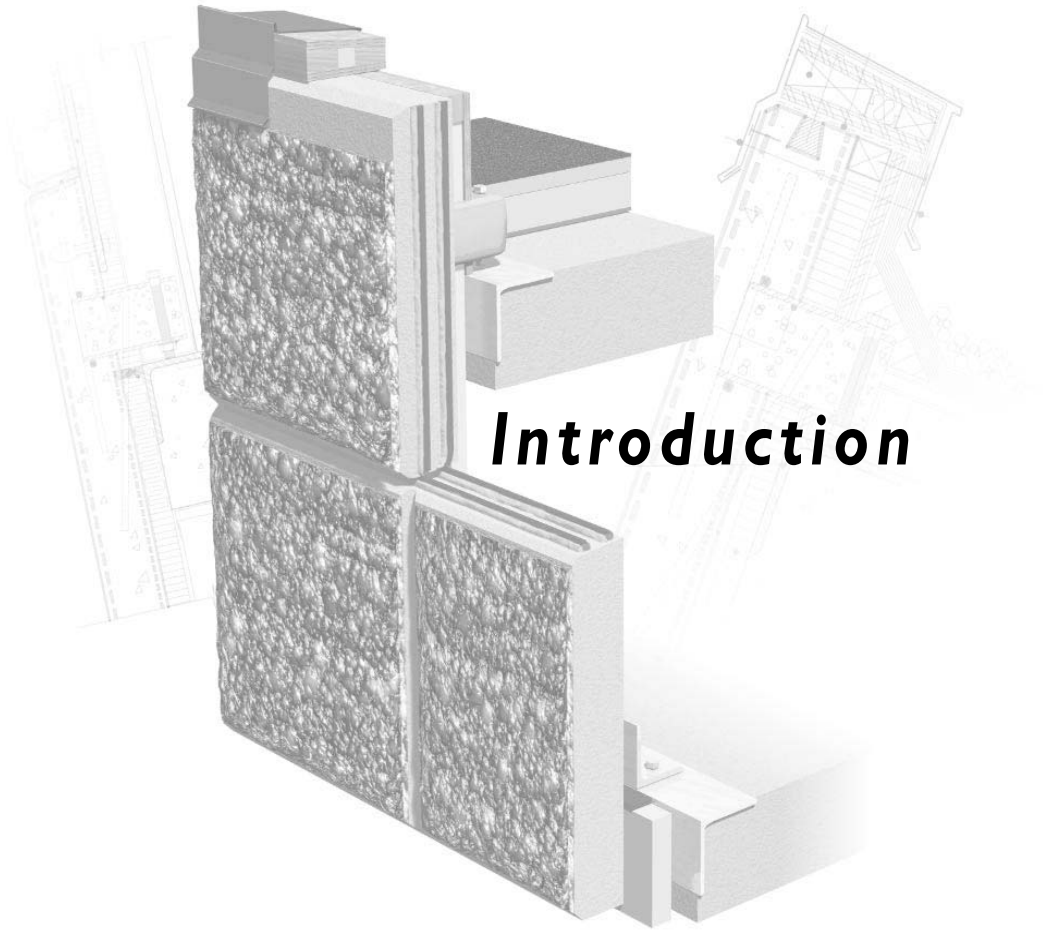

Introduction

BACKGROUND

Architectural precast concrete has been used as cladding on buildings since the 1920s becoming increasingly popular since the 1950s. Recently the range of products has broadened as manufacturers have incorporated new insulating and anchoring methods as well as rainscreen technology. Current panel types include conventional, with and without insulation, and insulated sandwich, with and without drainage.

A range of design aesthetics can be achieved because of the variety of shapes and finishes that are available. Various materials may be cast on the face of panels to supplement the colours and textures attainable with exposed aggregate finishes. Natural stone and clay masonry have been attached to precast panels to provide an additional choice of exterior or interior finish.



Panels are fabricated under controlled factory conditions to exacting tolerances and manufacturers are now producing thinner panels with simplified connections. Composite panels with punched windows provide the entire wall assembly from a single source. Year round construction is possible with panels that are quickly erected at the site, providing the opportunity to rapidly enclose a building and speed up construction.

Architectural precast systems, like others, are sensitive to the installation and performance of each component and it is important to consider the overall requirements of the envelope during design and construction. Understanding how architectural precast concrete can be used as an integral part of the building envelope enables designers to make appropriate design choices.

THE BEST PRACTICE GUIDE

The purpose of this Guide is to summarize current information on architectural precast concrete and to provide designers with an understanding of this construction product illustrating recommended design details and site practices.

The Guide is organized to take the user from a discussion of the characteristics of architectural precast concrete, through a presentation on the fundamentals of building envelope performance, to best practice assemblies, details and specifications. The final two chapters deal with quality assurance during the design, fabrication and erection process, and maintenance and renewal of the architectural precast during its service life.

This *Best Practice Guide* is intended to be a living document and will be updated as feedback is received and as more current technical information becomes available. Users are invited to submit their comments and suggestions to:

Canada Mortgage and Housing Corporation
Research Division
700 Montreal Road, Ottawa ON K1A 0P7

The Guide does not consider the requirements of architectural precast that is installed as the façade of unenclosed structures such as parking garages and stadiums. As well, the Guide does not consider the requirements of architectural precast that is installed on a building with extreme interior environmental conditions. Finally, the Guide doesn't address unusual structural issues or the structural requirements of load bearing architectural precast.

The Guide is not intended to replace professional advice. When this guidance is incorporated into buildings, it must be reviewed by knowledgeable engineering and building envelope professionals and reflect the specific unique conditions and design parameters of each building. Use of the Guide does not relieve designers of their responsibility to comply with local building codes, standards and by-laws with respect to the design and construction of the building envelope.

An attempt has been made throughout the document to provide the user with direction to other useful reference material. The Canadian Precast/Prestressed Concrete Institute is an excellent source of information on design and construction practices specific to architectural precast concrete. They have generously permitted extensive use of their published material in the Guide. The following is the contact address and numbers for that organization.

Canadian Precast/Prestressed Concrete Institute
196 Bronson Avenue, suite 100 Ottawa ON K1R 6H4
Tel: (613) 232-2619, Fax: (613) 232-5139
Toll Free: 877-937-2724
Web site: www.cpci.ca

The construction industry has historically been provided with good research and guidance on design and construction issues from Canada Mortgage and Housing Corporation, the National Research Council of Canada through its Institute for Research in Construction and Public Works Government Services Canada. The following are the contact addresses and numbers for these organizations. Their publication lists include many directly relevant documents.

Canada Mortgage and Housing Corporation
700 Montreal Road
Ottawa, ON K1A 0P7
Tel: 1-800 668-2642
Fax: (613) 748-4069
Outside Canada: (613) 748-2003
Web site: www.cmhc.ca

National Research Council of Canada
Institute for Research in Construction
Publications Section
1200 Montreal Road
Ottawa, ON K1A 0R6
Tel: 1-800 672-7990
Web site: www.nrc.ca/irc

RPS Documentation Center
Public Works Government Services Canada
Place du Portage
Phase III
11 Laurier Street
Floor 8B1
Hull, QC K1A 0S5
Tel: (819) 956-4751
Fax: (819) 956-3875
Web site: pwgsc.gc.ca/rps/aes/tech/text/rpsdoc-e.html

2

CHAPTER TWO



***Characteristics
of Architectural
Precast
Concrete***

GENERAL

Architectural precast concrete provides a cladding with a high quality, factory produced architectural texture and finish and may provide most or all of the building envelope performance requirements for the exterior wall (see Chapter 4). Material and finish selection requires an understanding of how mix design affects durability and what is achievable on a consistent basis in a precasting operation.

The use of architectural precast wall panels can be cost effective because of reduced site construction time and site labour. The advent of larger capacity hauling and lifting equipment required for handling and erecting precast concrete elements has allowed builders to install larger panels and reduce construction time, enclosing the building more quickly. This can be very beneficial in Canadian climatic conditions with short construction seasons.

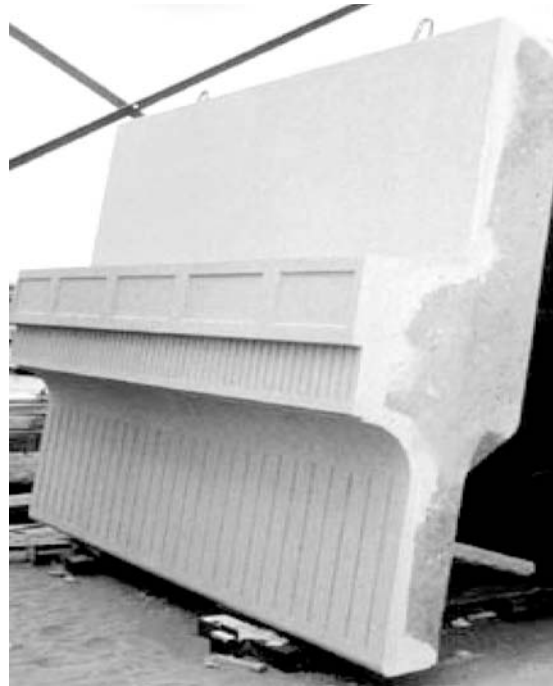

Typically, architectural precast panels used as a cladding are supported from the structure. Anchorage to transmit gravity, wind and seismic loads must be integrated into the panel design. CSA Standard A 23.4 "Precast Concrete Materials and Construction" provides useful guidance.

MATERIALS AND FINISHES

The design team must define the performance characteristics of the concrete mix in the precast panels and select the desired finished appearance. Final mix design should be left to the precaster. Architects should review the appearance of the precast panels that employs the precaster's mix design by applying the pre-bid sample procedure that follows.

Consideration of the following parameters is required:

Concrete Mix Design:

Strength

- Concrete strength relates not only to in-service requirements, but also to minimum strength required for early stripping and panel handling, shipping and erection.
- Strengths in the 35 MPa (5000 psi) range at 28 days generally satisfy production and durability requirements. Stripping strengths are normally in the 20-35 MPa (3000-5000 psi) range.

Air Entrainment

- To provide freeze thaw durability, air entrainment of the base panel mix should range between three per cent and six per cent.
- Air entrainment targets change for architectural face mixes that involve varied aggregate grading, high cement content and low slumps. Specific discussions with the precaster are suggested based on the severity of the climate and the characteristics of the face mix.

Aggregates

- Aggregates must have locally proven durability and be free of impurities such as iron oxide.
- Aggregates in face mixes designed for heavy exposure of the aggregate are sometimes gap-graded. Leaving out certain intermediate sizes of course aggregates concentrates the remaining sizes and improves architectural appearance.
- Round aggregates exposed in face mixes tend to retain less dirt and atmospheric pollution than rough textured aggregates.
- Minimum thickness of a face mix should be 25 mm (1 inch) or at least 1 1/2 times the maximum aggregate size used.

Cement Ratio

- Water cement ratios and cement-aggregate ratios for both the concrete face mix and structural back-up mix should be adjusted by the precaster to limit bowing or warping of panels.

Colours

- Colour (and texture) are varied with aggregate and matrix colour, size of aggregate, finishing processes and depth of exposure.
- Final samples should be as close as possible to full size and finished in accordance with the plant's production techniques. The sample should be reviewed under wet, dry and a variety of lighting conditions. Three or four panels [1,200 mm to 1,800 mm (4 – 6 feet) square] are required to establish an acceptable range of colour and texture.
- For exposed aggregate finishes, it is useful to match the colour of the sand and cement to the colour of the coarse aggregate to maintain a uniform appearance.

Texture

- Textures can be established by the form face prior to casting, created by treatment after casting during precasting operations or finally after the concrete has hardened.
- In general, the cost of textures rises as follows:

Lowest Cost		Highest Cost	
Smooth off the form	<ul style="list-style-type: none"> • Exposed aggregates by using chemical retarders or water washing • Form liners • Sand or abrasive blasting 	<ul style="list-style-type: none"> • Exposed aggregates by acid etching • Hammered ribs (fractured fins) • Sand embedment 	<ul style="list-style-type: none"> • Honing or polishing • Stone Veneer • Tooling or bush hammering • Brick facing

Smooth off the Form

- Smooth off the form finishes are amongst the most economical, but are *not normally recommended* as they are subject to many aesthetic concerns:
 - Colour variations are common with grey or grey pigmented cements. White cement provides improved uniformity.
 - Flat glossy impermeable forms must not have any surface imperfections and must be constructed to avoid leakage of finishes. Vibration of forms is much preferable to the use of internal vibrators that can damage form surfaces.
 - The uniformity of manufacturing procedures is critical including cleaning, release agent application and uniform concrete quality.
 - Repair of smooth surfaces after casting is extremely difficult and the results are often noticeable after weathering.
- Use the following approaches to reduce the aesthetic limitations of smooth concrete:
 - Create profiled surfaces.
 - Subdivide large panels into smaller areas with false joints.
 - Introduce shadow effects.

Exposed Aggregates by Chemical Retarders or Water Washing

- Chemical retarders usually applied to the form surfaces, retard the hardening of the concrete matrix near the surface. The surface layer of matrix is removed shortly after stripping from the form by brushing or pressure washing. This removes a portion of the cement paste between the coarse aggregate.
- Chemical retarders are available to achieve various depths of exposure. (normally 1/3 the size of the aggregates)

Form Liners

- A wide variety of materials can be used as form liners to create appearances that simulate wood, textured or striated panels or bush hammered concrete. The precaster should be consulted for techniques to avoid discoloration due to different absorption of mix water due to the form liner, and ensure the liner design allows easy stripping. Liner widths need to be considered to minimize form joint lines. Form liners can be used on the whole panel or be limited to portions of the panel surface.

Abrasive Blasting

Abrasive blasting of surfaces generally creates three degrees of exposure:

- Light blasting removes only the surface film of cement paste exposing the edges of the coarse aggregate closest to the surface.
- Medium blasting removes additional cement paste exposing equal areas of coarse aggregate and cement paste.
- Heavy blasting removes the cement paste such that the coarse aggregate is the dominant surface texture.
- While blasting can be used for any degree of exposure, it is generally only economical for light aggregate exposure. The use of chemical retarders combined with sandblasting provides more economical medium or deep exposures.
- Uniformity on blasted surfaces is more easily achieved with heavier sandblasting, whereas light sandblasting requires highly skilled operators and careful assessment of large panels to establish uniformity.
- Blasting removes the natural reflectance of aggregates resulting in a somewhat duller appearance of the finish compared with panels produced with chemical retarders.

Acid Etching

Acid etching is used often for a light exposure. The process dissolves the surface cement paste revealing the sand and makes a small percentage of the coarse aggregate visible. Guiding principles include:

- Use only acid resistant siliceous sand and aggregate such as quartz or granite. Other carbonate aggregate such as limestone, dolomite or marble may discolour and dissolve with exposure to hydrochloric acid.
- Best results are achieved if acid etching is conducted on concrete at design strength and at uniform temperature.
- Protect all galvanized metal surfaces from exposure to acid with coating such as bituminous paints, vinyl chlorides or chlorinated rubber.
- Thoroughly flush panels with potable water after etching to stop the penetration of chlorides into the panel and to control efflorescence.

Bush Hammering

Bush hammering uses power-driven steel chisels to distress the surface of the concrete.

- Bush hammering removes approximately 4 mm (3/16 inch) of hardened concrete and fractures the larger aggregates near the surface.
- The technique is most suitable for flat or convex surfaces.
- Aggregates such as limestone, dolomite, marble or calcite are most suitable. Quartz and granite-based aggregate mixes are difficult to bush hammer and may fracture into rather than across the surface leading to increased water penetration.
- It is recommended to increase reinforcing cover to 50 mm (2 inches) is recommended when bush hammering precast.
- Discuss with the precaster the geometry of ribs or fins intended for bush hammering to determine what is economical and achievable.
- The same appearance can be obtained more economically with a form liner and abrasive blast of the panel after stripping.

Sand Embedment

A layer of sand is placed inside the forms. Stones and other objects are pressed into the sand before casting the concrete.

- Where heavy exposure of stone facing material is desired, stones can be handset into a sand bed within the form to a depth that keeps the back-up concrete 25 to 35 per cent of the stone diameter from the face.
- Take special care with aggregate density at panel edges.

Clay Product Faced Precast (Brick, Tile and Terra Cotta)

Facing precast with clay products can provide many advantages:

- Long-term use of scaffolding or lift platforms is eliminated.
- Plant production avoids site application problems such as temperature control.
- Batching of mortar and curing times and conditions can be controlled.
- Special considerations should be made to assess the bond between the clay products and precast back-up, to assure uniformity in aesthetics, and to limit panel bowing.

Bond

- Select face units 13 to 19 mm (1/2 to 3/4 inch) or thicker with the back of the unit scored or keyed to improve bond.
- Clay products with 6-9 per cent water absorption provide good bonding potential.
- Face units with a high initial rate of suction (absorption) should be soaked in water prior to placement.
- Clay products are subject to expansion due to re-absorption of water following removal from the kiln, whereas concrete undergoes shrinkage. Generally the bond between concrete and clay masonry adequately overcomes these strains for panels up to 9 m (30 feet) in length.

Aesthetics

- Bricks must be dimensionally accurate (+0, -3 mm) (+0, -1/8 inch) for use with typical pre-formed placement grids.

Panel Bowing

Material properties of clay product facings and concrete panels are significantly different and can contribute to panel bowing. The designer and precaster need to consider the following:

- Interior to exterior temperature differential across the panel.
- Coefficients of thermal and moisture expansion of the materials.
- Shrinkage of the concrete and expansion of the facing are not a problem if clay products are aged at normal outdoor humidities for 2 – 4 months after manufacturing.
- Ratio of cross sectional areas of the materials and their moduli of elasticity.
- The reinforcement type, location and amount.
- Use of prestressing.
- The type and location of connections to the structure.

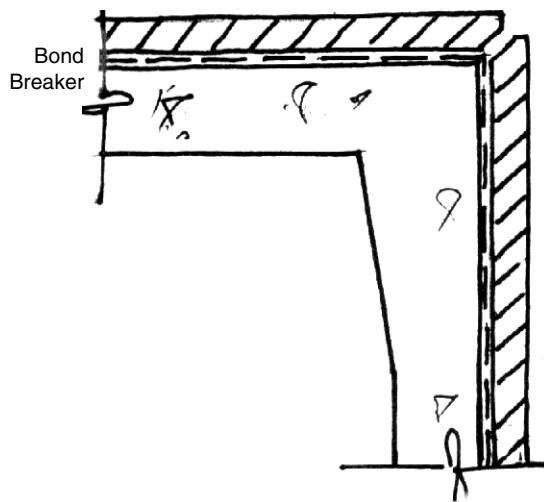

Stone Veneer-Faced Precast

Stone veneer-faced panels are fabricated by placing the veneer complete with anchorage in the mold, followed by application of a bond breaker and concrete casting. Design development requires the interaction of stone suppliers, testing, engineering and precasters. The following arise:

- Coordination of stone purchasing including arrangements for colour samples, quarrying, transport, cutting and finishing must often be established prior to tendering of the main construction project. Long lead times are required for international shipping.
- Stone anchorage to the panel is most often specified by the main design team engineers with detailed design completed by the precaster's engineer who produces the shop drawings.

- Stone veneer durability varies widely with stone type. Designers should review previous use of stone from the same quarry that has been exposed to similar climatic conditions.
- The required thickness of stone veneer varies widely with the properties of the stone and the anchorage design. Generally, minimum thickness is 30 mm (1 1/4 inches) for granite and 50 mm (2 inches) for marble and limestone.
- Bond breakers can be 6-10 mil polyethylene or 3-6 mm (1/8 – 1/4 inch) closed cell polyethylene. The latter provides preferred movement capability, although stone breakage can be a concern during transport to the jobsite.

- Stone anchorage most often involves the use of stainless steel hair-pin clips or cross-stitch dowels.

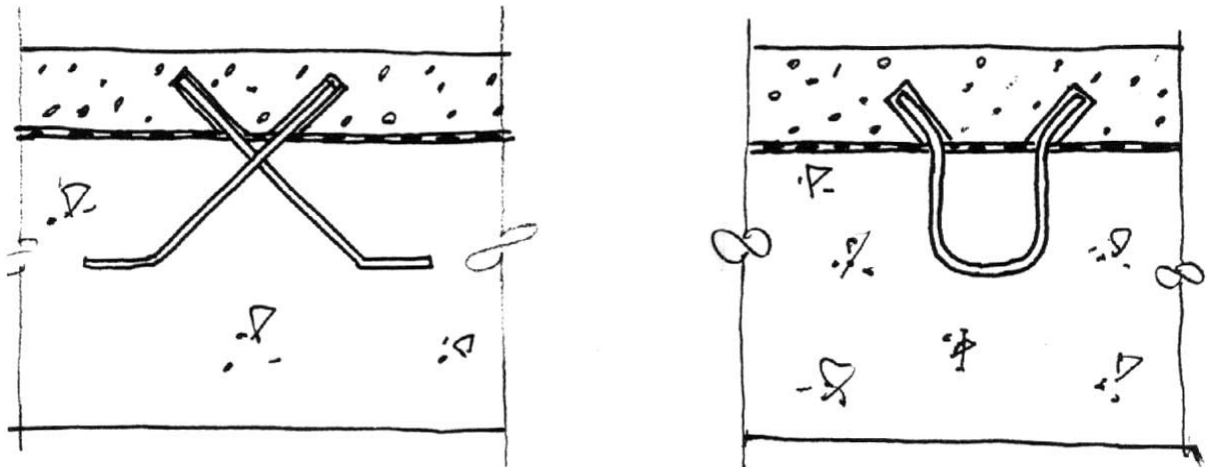

Samples and Mock-Ups

The architectural design team must interact with precasters during design development to review samples and select the form, texture and final finishes. The following process is recommended:

Samples

- Each precaster intending to bid should be required to provide pre-bid samples showing the panel colours and textures (sample size generally 300 mm X 300 mm or 12 inches square). Technical descriptions of the concrete mix, aggregates and finishes should be provided and checked against the specifications. This prequalifies the precaster and allows competitive bids from firms with adequate capability.

Pre-Bid Conference

- Approved precasters and the general contractors should meet with the design team prior to the award of the precast contract to review material sources, production capability and schedules. Requirements for shop drawings, design submittals and mock-up panels should be reviewed.

Production Approval Samples

- The small samples described above are adequate to prequalify precasters, but one quarter to full size mock-ups are recommended to demonstrate materials, colour, texture, scale and patterns under changing light conditions. Mock-ups are particularly important for panels with multiple finishes, textures or veneers. As concrete is a natural material, an acceptable range of colour variation should be established using a series of samples.
- Assessment of mock-ups and samples should be made at distances and orientations similar to those found in the finished building, under varied light conditions and both wet and dry.
- The owner's representative should sign off on the approved sample.

MANUFACTURING CONSIDERATIONS

Mould configurations and materials vary by precaster and with the complexity of the job. In order for architectural precast concrete to achieve the economy necessary to compete with traditional building systems, the cost of facilities and mould fabrication should be distributed over many production units. This imposes a discipline of creating repetition in the design of the building facade. Variations of the original common element are possible but the relationship to the master mould should be maintained to achieve the maximum reuse of the mould. Examples of the use of the master mould can be seen on many buildings with repetitive spandrel shapes or window panel units dominant on the building elevations.

Master Moulds:

- Master mould concept develops moulds with the maximum number of re-uses per project.
- Changes to cast alternate panel shapes are provided through pre-engineered modifications to the master mould.

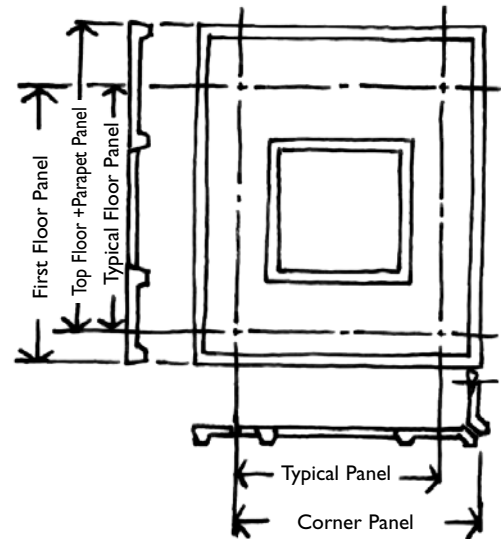

Conventional Moulds:

- Conventional moulds employ removable bulkheads at the perimeter to allow removal of the panel. These moulds allow 90 degree returns but reassembly and alignment is required after each casting.

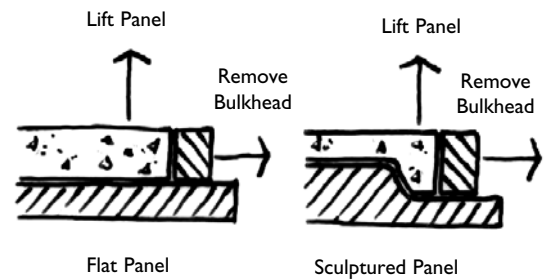

Envelope Moulds:

- Envelope moulds are box moulds with all sides remaining in place during casting and stripping. Set-up cost is high and not usually economical unless 25-30 units are required. Draft is required to allow stripping. Panel-to-panel joints must be slightly wider.

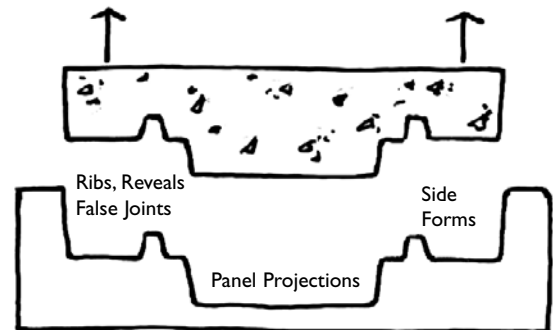

Shop drawings are normally produced by the precast contractor. The necessity of accurate shop drawings, proper coordination by the contractor and architect, and the review of these drawings by all trades is paramount. Many issues need to be carefully considered and incorporated into the design prior to final approval for production. Examples include location and tolerance for connections, interface tolerances and connection details with the structure and other elements such as windows, adjacent construction finishes, site lifting capacities and access. Incomplete architectural drawings and frequent drawing changes will cause delays and increase the cost of precast cladding.

TRANSPORTATION AND ERECTION

Erection of precast panels can be performed by either the precaster, an erection subcontractor, or the building general contractor, depending on the project and the particular construction team involved. Normally the precaster designs lifting devices and checks stresses induced in units during handling.

The drawings or specifications should note any structural limitations of the building frame with respect to precast erection. For instance, limitations may be necessary to balance loads by elevation, to require rigidity of shearwalls or that the schedule allows for the effects of concrete frame shortening due to shrinkage and creep.

Key aspects of transportation, storage and erection include:

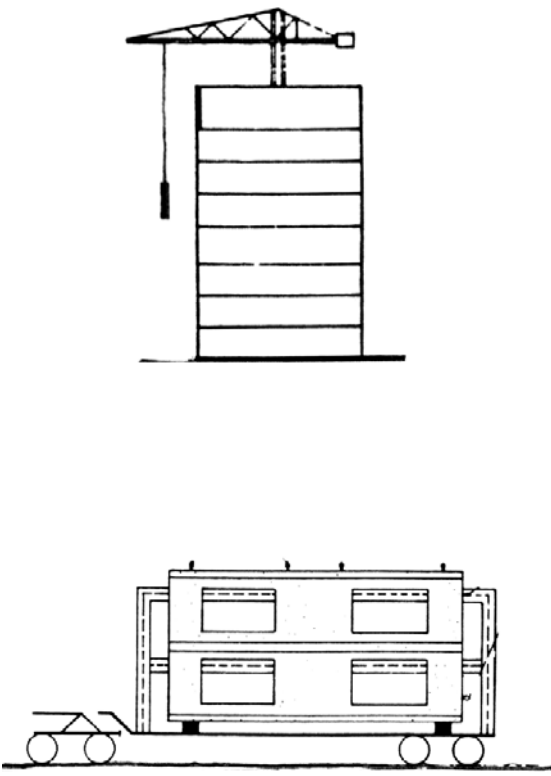
	<ul style="list-style-type: none">• Tower crane capacities of 10,000 kg (11 tons) are common in most urban locations. Panel sizes should be maximized in accordance with crane capacities.• The use of mobile cranes may provide more flexibility and accommodate larger panel sizes. Reach and crane access conditions must be carefully reviewed. • Panel sizes up to 3.7 x 12 m (12 x 39 feet) are accommodated by most hauling and handling equipment.
---	--

- Consider job site access, storage and lift angles to reduce erection costs.

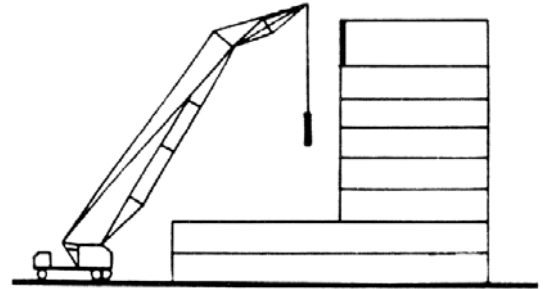

- Store precast units in a position similar to its final location on the building to avoid weathering patterns that won't be duplicated following installation. Define protection requirements if precast were stored for long periods on dirty sites.

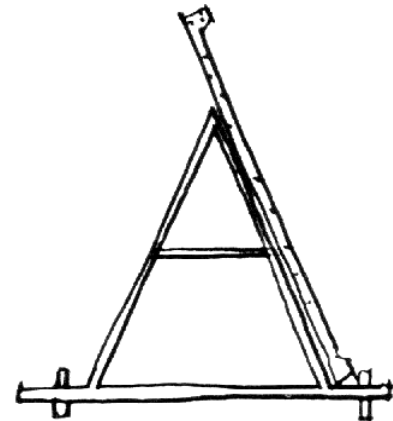

- Speed of erection and economy are directly related to crane type and size, to panel size, type of connections and the arrangement of the building frame. Connections should allow for initial setting of the panel, release of the crane and final alignment completed independently of crane support.

- Erecting precast soffits often requires unusual hoisting or jacking equipment. Combining spandrel panels with a soffit in a single unit can avoid this problem.

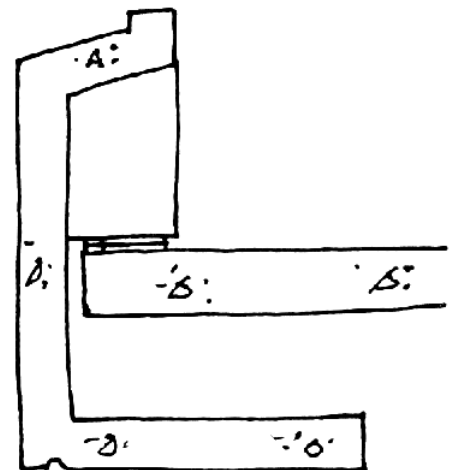

ANCHORAGE CONNECTIONS

Critical to the successful application of architectural precast concrete panels in construction is the design of the anchorage connections which attach the precast walls to the building frame. Typically, the engineering consultant does this in concert with the precast fabricator and erector.

Connections of architectural precast panels to the building must provide adequate anchorage to resist gravity, wind and seismic loads. At the same time, the connections have to allow horizontal and vertical adjustment to account for construction tolerances, final alignment of the panels during erection and sliding capabilities where they are designed to allow for thermal and shrinkage movements. Anchors must also be designed to minimize their impact as thermal bridges and penetrations of air and vapour barriers. Most precast wall panel anchoring systems involve one or more of the following types:

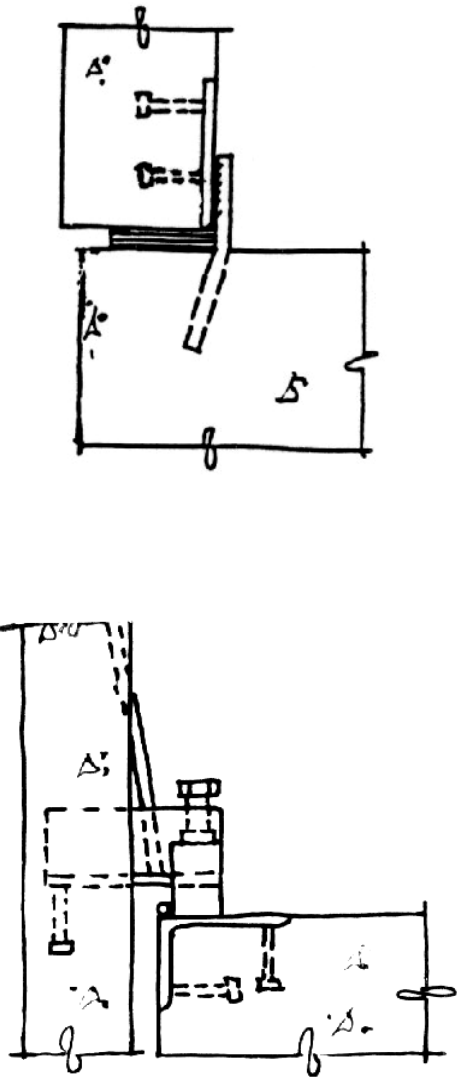

Direct Bearing Connections:

- Direct bearing connections transfer loads to the supporting structure or foundation. Also used where cladding panels are stacked and self-supporting for vertical loads with tie back connections to resist lateral forces.
- Plastic shims avoid rust staining.
- Eccentric bearing connections are needed above the first support level when movements of the support system are possible. Eccentric connections may be created by reinforced concrete corbels, cast in steel shapes or steel shapes welded to embedded plates after casting.

- Lateral tie back connections retain the panel in the required position and resist wind and seismic loads perpendicular to the panel.

- Some connectors are used for alignment with respect to adjacent cladding elements and do not normally transfer design loads.



- Typically an individual panel will require two gravity connections, normally located near columns in multi-level building frames, and two to four lateral tiebacks. Seismic connection design can be incorporated with one of the gravity or lateral ties at one end. Additional wind connections may be required and can be added as required.
- Freedom of movements in connections will allow for thermal movement and shrinkage within panels.

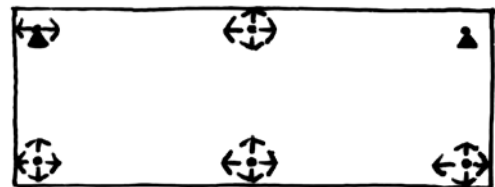
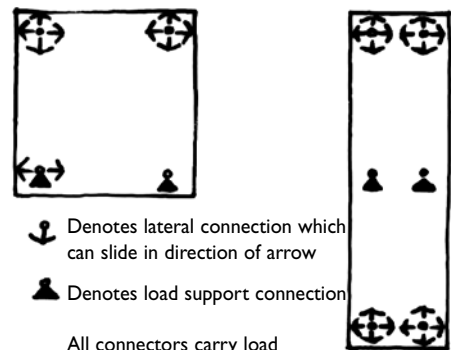
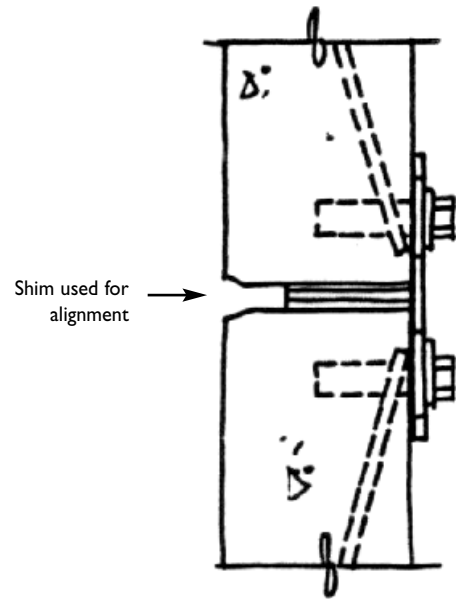
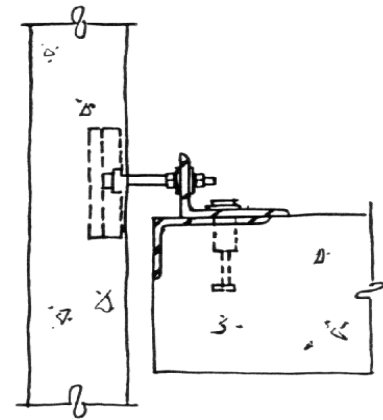

Connection location and design has a large impact on the erection process, important implications for the structure as a whole, and the performance of the building envelope. The designer should provide connection locations for the precast panels (normally at columns, floor beams or floor slabs). Additional considerations include:

- Locate connections for easy access for example above floor slabs, not below.
- Design connections to avoid penetration of the air and thermal barriers. This requires careful detailing, particularly when panels are erected after back-up walls are in place (not recommended). The sequencing of construction must allow for continuity of the air and thermal barriers around the anchorage points.
- Consider anchorage design in relation to flashing provided for cavity drainage and at window heads. This requires discussion with the precaster and erector.
- The use of grout, drypack or epoxies in connections is often not reliable. Special provisions must be made in cold weather.
- Use connections larger than technically necessary to avoid damage to the connections during handling and minimize loose hardware that could be mistaken for other sizes on site.
- Use plastic temporary shims between joints of non-loadbearing panels to establish panel spacing as required during erection. Recess shims left in place to allow proper sealant application.

One problem area has been the exposure of connection hardware to moisture leading to corrosion of the fastening system with sometimes catastrophic consequences. Special attention is required to prevent corrosion of panel connections when the design of the wall assembly requires that they be within the drainage cavity. This is addressed by the use of hot dipped galvanized steel, or in some extreme cases, stainless steel connecting hardware.

Steel anchor materials include plain black steel, zinc rich paint coated, hot-dipped galvanized, or stainless steel. The choice depends on the degree of exposure to corrosive elements and the required design life. The connection design can have varying degrees of complexity to provide for construction tolerances and adjustment both horizontally and vertically.

The anchorage system must match the building framing system and anticipated exposure conditions. Connect to or near the columns wherever possible. Concrete frames require hardware to be cast into the frame to receive the panels. Steel frames may require stiffening at the precast connection as well as additional adjustment capability in the connection hardware to account for frame deflection and rotation as the precast is attached. The specifications should indicate who supplies and installs these frames. Brackets may be required for large set back of panels from the building face. Finally, seismic requirements can play a significant role in the anchorage design.

3

CHAPTER THREE

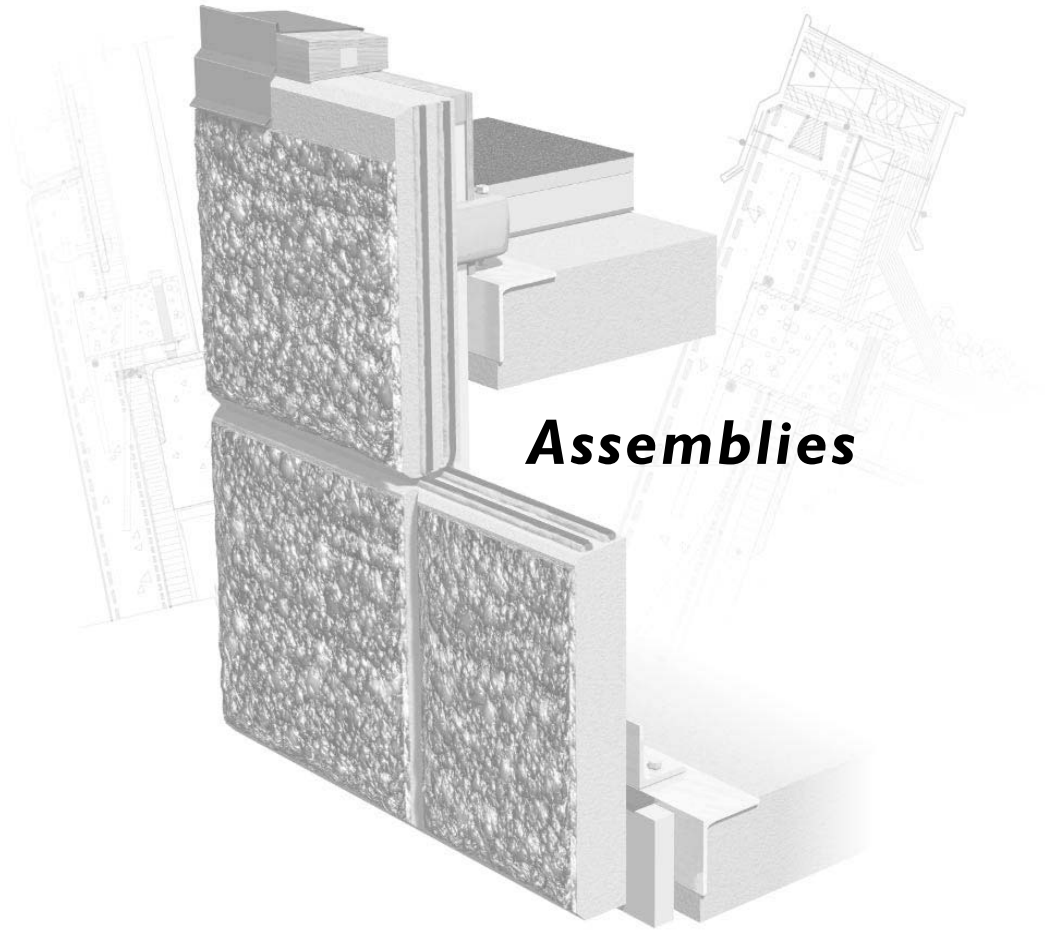

Assemblies

PANEL TYPES

Architectural precast concrete systems can vary in complexity from simple conventional systems to composite sandwich assemblies that function as the entire environmental separator.

Conventional Panels

Conventional architectural precast traditionally was a single exterior wythe which incorporated the desired finish. Conventional panels may be uninsulated but can also include a variety of site constructed back up walls constructed on site to complete the assembly.

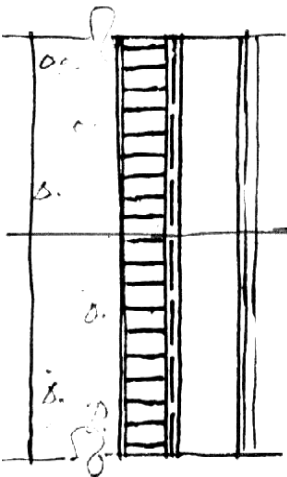
 <p>Finished precast panel External weather and air seal</p> <p>OR</p> <p>External weather seal and internal air seal</p>	<ul style="list-style-type: none"> Traditional uninsulated panels are suitable for unheated spaces such as dry warehousing and parking garages. Single or two-stage joints control air and water leakage. Uninsulated panels are outside the scope of this guide.
 <p>Finished precast panel</p> <p>Semi-rigid insulation with vapour barrier on inside surface</p> <p>Non-loadbearing steel studs</p> <p>Interior finish</p>	<ul style="list-style-type: none"> Adhered insulation installed with a vapour barrier (or spray-applied urethane insulation) combined with steel studs provides economical commercial and institutional enclosures with moderate interior humidity (35 per cent) and moderate climate (< 5,000 degree days). Two stage joints are preferred for effective control of rain penetration and air leakage. (see page 30) Narrow steel studs, not required to carry wind loads, accommodate services in exterior walls.

Conventional Panels

- Conventional precast rainscreen wall with steel stud, concrete block or solid concrete backup. The exterior face of the backup wall provides a structural substrate for an air and vapour barrier. Insulation is applied on the cold side of the membrane. An exterior weather seal deflects rain and the drained and vented cavity provides a second line of defense against rain penetration.
- In a rainscreen assembly, back-up walls carry the wind load. Air leakage, heat loss and rain penetration at precast hardware locations is problematic. Solutions often involve the use of foamed in-place urethane to maintain the integrity of the air barrier and membrane flashing in the cavity to redirect water.

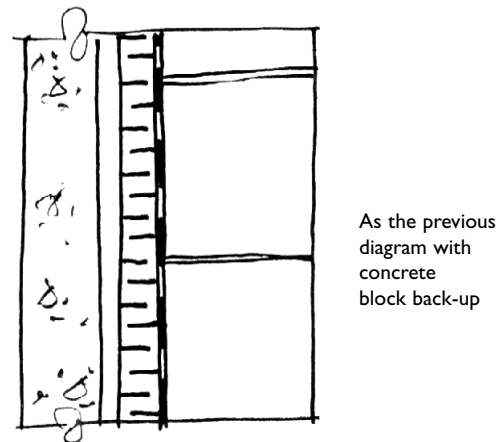
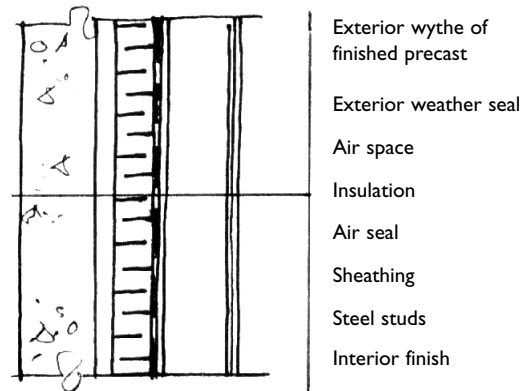

Sandwich Panels

Sandwich architectural precast incorporates thermal insulation between an exterior architectural wythe and an interior structural wythe. Connecting ties are embedded in the exterior wythe and a rigid insulation is applied with or without a polyethylene bond breaker against the wythe. The interior wythe is then cast on the insulation to complete the sandwich. The ties must be designed to support the exterior wythe through the fabrication, transportation and erection processes. They must also accommodate the differential thermal movement which will occur because of the large thermal fluctuations of the exterior wythe.

Composite panels allow the inner and outer precast wythes to share the externally imposed loads through rigid ties or interconnection of the concrete. The potential for thermal bowing of composite panels must be recognized and controlled through reduction in panel size and degree of composite action designed into panels. Non-composite panels have relatively flexible ties allowing differential thermal movement between the inner and outer wythes. A rigid interior wythe resists all loads on the panel.

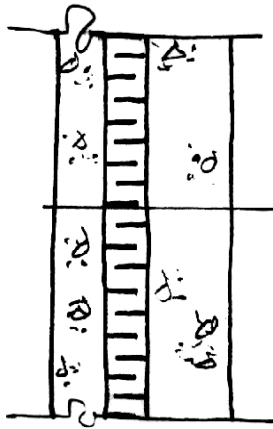

Exterior wythe of finished precast with weather seal

Extruded polystyrene insulation

Interior structural precast wythe with air seal

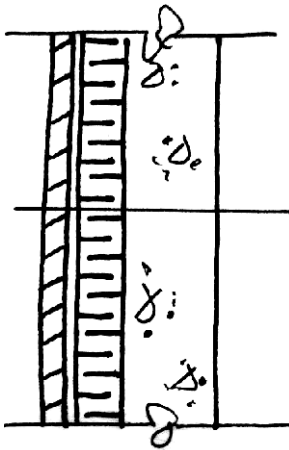

Exterior wythe of precast or stone with weather seal

Drained and vented air space

Extruded polystyrene insulation

Interior structural precast with air seal

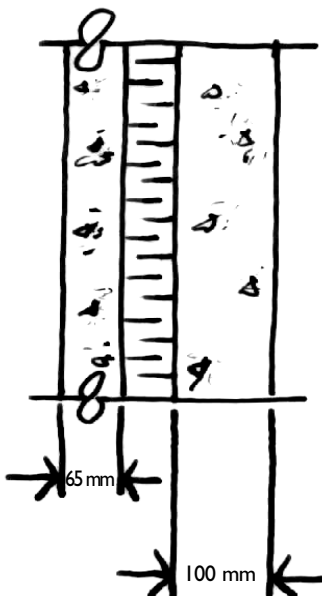

65 mm

100 mm

Key Advantages Include:

- Complete exterior wall in one unit completed under factory conditions including exterior finish, insulation and structural interior wythe (with or without an interior finish)
- Accommodates rainscreen panel joints or fully drained and vented cavity construction for reliable control of air and water leakage.

Design and Construction Considerations

- Interior structural wythes are generally 100 mm (4 inches) minimum thickness, exterior wythes are a minimum of 65 mm (2 1/2 inches) if precast and 30 mm (1 1/4 inch) if granite.
- Panels with false joints may be thicker. The structural thickness is measured from the back of the panel to the base of the joint.
- Review reinforcement cover and aggregate size with precaster.
- Maximum panel dimension for composite panels is generally 48 times the overall panel thickness excluding the insulation. Consult the precaster for maximum panel size.
- Maximum panel weights are approximately 9,000 Kg (20,000 lbs). Weights are governed by shipping regulations, plant and jobsite cranes and handling equipment.

PANEL LAYOUT

The most vulnerable area in precast clad wall assemblies is the joint between panels. The number and location of joints in the architectural design should be minimized to reduce the potential for sealant failure and long-term maintenance, while recognizing the limitations of manufacturing and handling. The design of the joint locations and configuration can be as important as—if not more important than—the panel itself.

Sandwich panels provide excellent continuous thermal, air and moisture barriers as elements. However, the joints are discontinuities in the wall system and must be sealed to the air and thermal layers or failure can occur. Joints between panels are typically located near structural elements, and designers must locate panel joints to avoid problems of access for sealant installation or replacement.

Typical Precast Panel Layout

Precast panel layout on a façade has a large impact on joint complexity and costs. Panel sizes should be maximized to minimize joint sealant cost and maintenance. Only joints essential to accommodate panel and structural movement should be provided (false joints to simulate real joints may be added if desired for appearance). Most panel layout schemes fall into the following four categories:

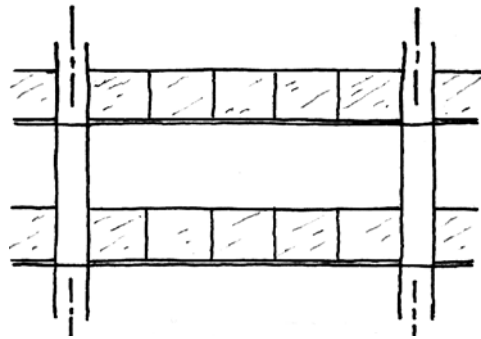
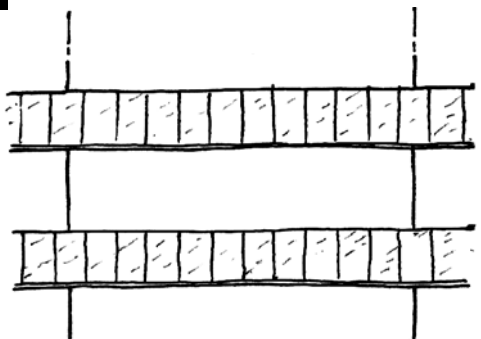
<p>Horizontal Precast Spandrels with Vertical Column Covers</p> <ul style="list-style-type: none">• Horizontal spans of up to 10 m (33 feet).• Joints at window heads and sills, and column covers.• Add false joints to achieve architectural effects.• Column covers can sometimes be incorporated as part of spandrel panels.	 <p>The diagram shows a cross-section of a precast concrete wall assembly. It features two horizontal rows of precast panels. Each row is supported by two vertical column covers. The panels are connected to the column covers at their ends, and there are joints between the panels in each row. The column covers are shown as vertical rectangular elements that extend above and below the panel rows.</p>
<p>Alternate Bands of Precast Spandrels and Glazing</p> <ul style="list-style-type: none">• Horizontal spans of up to 10 m (33 feet).• Joints between windows and panels.• Add false joints to achieve architectural effects.	 <p>The diagram shows a cross-section of a precast concrete wall assembly. It features two horizontal rows of precast panels. The top row consists of solid precast panels, and the bottom row consists of glazing units. The panels are supported by two vertical column covers. There are joints between the panels in each row, and the glazing units are shown as separate elements between the panels.</p>

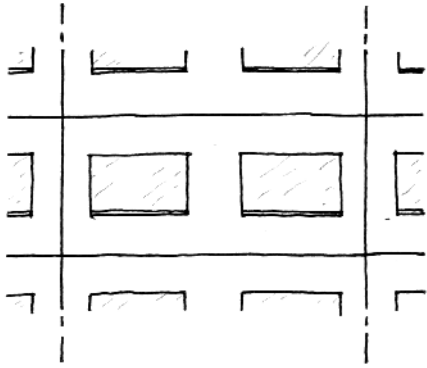

Punched Windows

- Depending on structural bay width, panels can span horizontally for approximately 10 m (33 feet) or vertically up to four stories.
- Locate horizontal joints above the floor line.
- Locate vertical joints between panels.
- Panel-to-window joint is controlled by the precaster.

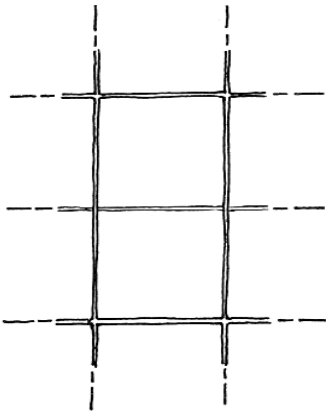

Solid Wall Panels

- False joints are often used to delineate floor lines.
- Locate horizontal joints above the floor line.

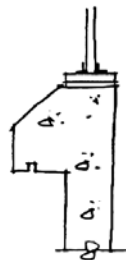
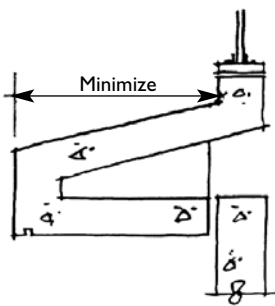

Surface Water Management and Staining

- Rain water and snow melt moving over the precast cladding surface deposits dirt in concentrated locations and washes other areas clean. The patterns created by deposition and washing can be anticipated and controlled.
- Minimize horizontal or low sloped elements that collect dirt. Minimum slope should be 1:3.
- Provide protection for vertical surfaces with steeply sloping overhangs and drips at storey levels to reduce dirt washing onto vertical surface and to provide improved shedding.

- Vertical ribs or grooves distribute water run-off and prevent horizontal or diagonal distribution.
- Medium textured finishes, while accumulating more dirt, do so more uniformly.
- Dark colours including grey mask dirt marking.
- Water run-off will tend to follow vertical channels, pilasters, window frames and panel joints. Maintain these water paths from top to bottom to carry run-off and dirt to the ground. Terminate horizontal elements clear of vertical projections to allow the washing action.
- Provide drips in precast above windows, or provide drip flashings as part of the window junction to avoid run-off etching of glass surfaces.

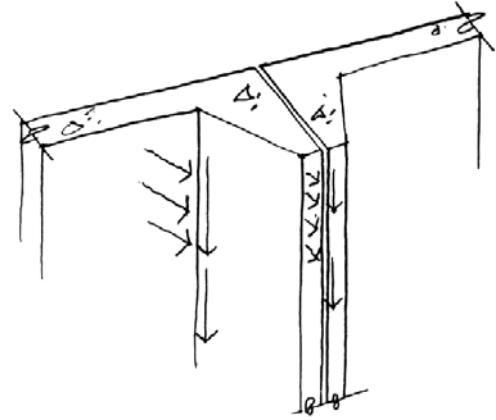

Preferred Drip Design and Location

- All overhanging precast elements should be provided with drips to break the surface tension of water flowing along an horizontal or inclined surface.
- Drip profiles should include sharp edges.
- Chips in the edges of precast sections create drips unintentionally. Provide radiused corners on panels to avoid chipping.

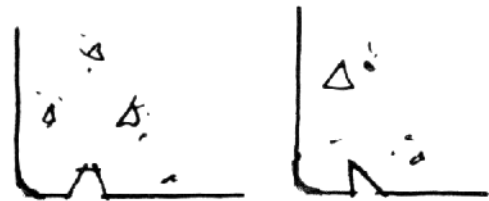
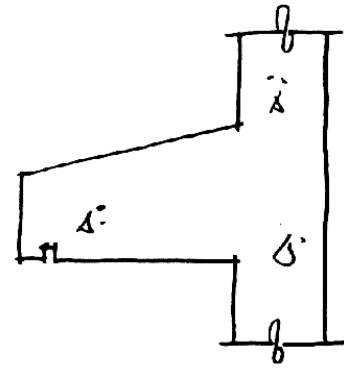

PRECAST PANEL EDGE DESIGN

Precast panel edge design adjacent to joints should consider the following:

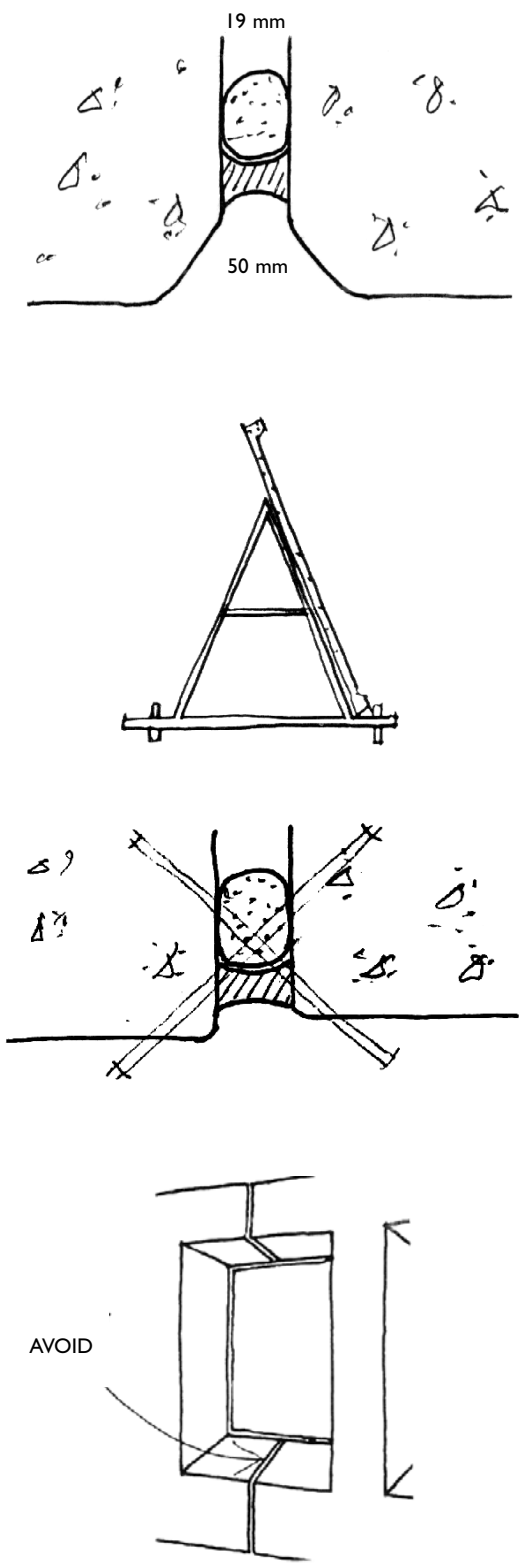

- Locate joints in recesses or reveals to screen the joint from rain and to reduce weathering effects by channeling rain runoff.
- Chamfer panel edges to reduce edge damage and to mask differences in alignment between panels at the joints.
- Avoid butt joints that require low tolerance for flatness and form shadow lines if the panels bow.
- Avoid joints in sloping sills or joints that split the window opening (very difficult to maintain integrity).

Types of Joints

Once the frequency and therefore the length of panel-to-panel joints are minimized with panel layout, a choice must be made between single-and two-stage joints.

Single-Stage Joints

These joints are characterized by a single line of defense with respect to rain penetration and air leakage.

Key Considerations Include:

- Simple configurations provide ease of installation and low initial cost.
- Well understood by the sealant trade, but performance relies on near perfect workmanship.
- Small failures in sealants will allow significant water penetration and air leakage.
- Sealants are exposed to the full deteriorating effects of ultraviolet light, water and temperature cycles and have reduced service life.

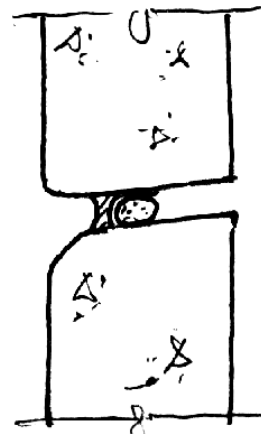

Horizontal

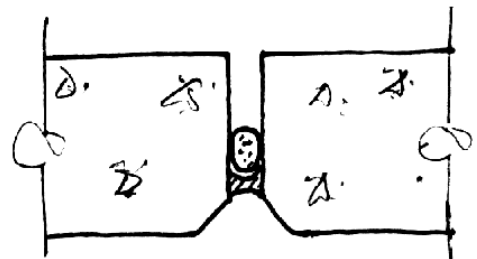

Vertical

Two-Stage Joints

Based upon the rain screen principle, these joints have an inner air seal and an exterior weather seal. The space between the inner and outer seals is vented and drained to the exterior.

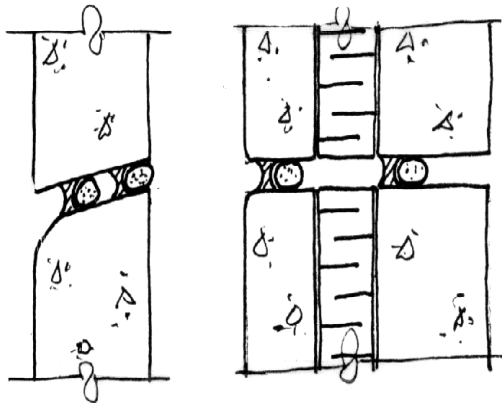

Vertical Section

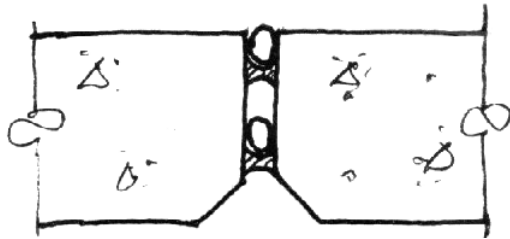

Horizontal Section

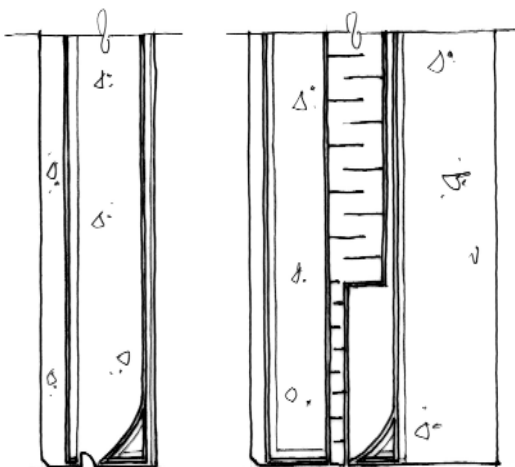

Section at Sealant

Key considerations include:

- The preferred jointing system for best practice.
- The exterior weather seal prevents most direct rain entry.
- The interior air seal is protected from the deteriorating effects of ultraviolet light and direct wetting leading to longer service life. It also acts as a secondary water seal when tooled to the exterior at the base of the panel.
- The two stage joint concept is more difficult to install and inspect and is hidden from view after the weather seal is installed.
- Show clear joint details on shop drawings.
- Continuity of the air seal must be carefully considered during design in three dimensions to make sure the intended connections with other elements can actually be made during construction.

Construction

- Minimum panel thickness 100 mm (4 inches) at joints.
- Panel-to-panel joints 25 mm (1 inch) are preferred (or as required for thermal movement and sealant capability).
- If possible, install the interior air seal from the exterior to avoid discontinuities at floor slabs, columns and across shear walls. This requires the use of rollers to set backer rods, long nozzles on sealant guns and careful tooling by the trade.
- Increased joint width may be necessary to access the interior seal from the outside face of the panel.
- Drain and vent the horizontal weather seal at the intersection with the vertical joints. This directs water flow down the sealant lines and controls panel staining. Consider leaving joint open for 19 mm across joint.

Joint Sizing and Sealant Selection

Elastomeric sealants are installed at the joints within and between precast concrete panels as well as other cladding elements. Sealants are installed to resist ingress of precipitation, and depending upon the configuration of the joint(s) selected, the performance of the sealant joints may affect the key factors for determining the minimum width of the panel joints:

- Joint width (J_w) resulting from panel movement due to thermal fluctuations can be calculated with the following simplified formula:

$$J_w = (100 \div S_m) \times C_t \times \Delta T \times L$$

such that,

S_m = sealant movement capacity, in per cent

C_t = coefficient of thermal linear expansion (typical value for concrete 3.3×10^{-6} m/m/°C (6×10^{-6} in/in/°F))

ΔT = the range of minimum and maximum temperature

L = effective panel length or height

Similar calculations can be made for the effects of moisture absorption in the precast panels, frame deflection/shortening as well as creep if it is a concrete structure. Most panel configurations will likely defer to the minimum joints sizes (presented below) that account for construction tolerances, as well as minimum application width for installation.

- The minimum size joint that can be installed for a single-stage joint is 19 mm (3/4 inch) wide, and for a two-stage joint, 25 mm wide (1 inch). These minimum, nominal joint widths, would also account for construction tolerance to ensure that the differences in the actual shop drawing dimensions may be adaptable to actual construction. It would be prudent to assume that any joint could have a tolerance of ± 6 mm ($\pm 1/4$ inch). If the joint were to be up to 6 mm (1/4 inch) narrower than required in the drawings, the joint sizes for single and double stage joints would become a minimum of 13 mm (1/2 inch) and 19 mm (3/4 inch) respectively.

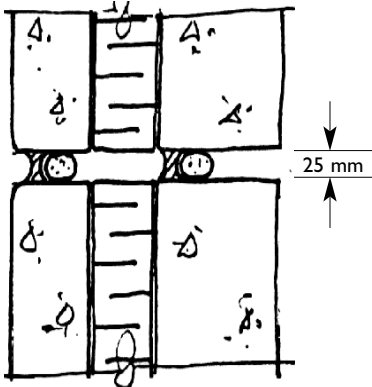
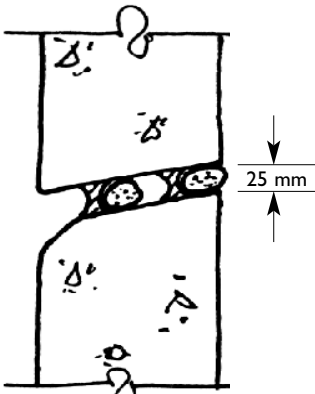
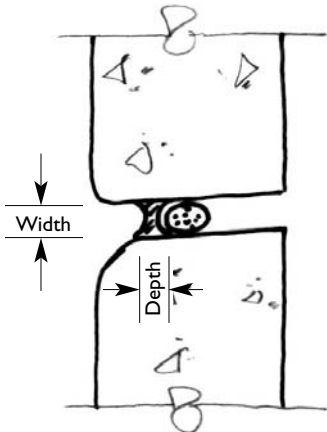

The key factors for determining the profile of sealant joints include:

- The joint width of the joint, as determined above, should be twice the dimension of the depth at the centre of the sealant bead. This allows for the sealant to stretch and compress without causing undue stress to the sealant material and its adhesion to the precast concrete panels.
- The sealant must be installed with a closed cell backer rod, typically polyethylene or polyurethane foam. The backer rod should be 25 per cent larger than the joint to ensure it is under compression once placed into the joint. The backer rod should be located at a consistent depth to ensure the proper sealant profile can be tooled without causing the sealant to push the backer rod out of place. The tooling of the sealant is critical to ensure that it is applied in continuous, intimate contact with the concrete panel edges, thereby ensuring better adhesion.
- The typical sealant materials used for precast concrete panel joints are polyurethane (single and multi-component) as well as single component silicone. Although polysulfide sealant was widely used in the past, it is less common today.
- Sealants are either a neutral (moisture) or solvent cured material. The compatibility of a specific sealant type should be reviewed during the construction mock-up stage of a given project.
- If different sealants are applied in contact with each other, it is necessary to review the compatibility of sealants curing at the same time.
- The application conditions are critical. High relative humidity and moisture within the concrete panels may lead to premature adhesion failure of the sealant. It is important to ensure that the surfaces are dry, and the temperature at the time of application not below manufacturer's recommendations. Priming must also conform with sealant manufacturer's instructions.
- Single component polyurethanes and silicones should comply with the requirements of CAN2-19.13-M87, "Sealing Compound, One Component, Elastomeric Chemical Curing". Multi-component polyurethanes should comply with the requirements of CAN2-19.24-M90, "Sealing Compound, Multi-Component Chemical Curing". The following material properties and requirements should be incorporated into the 07900 specification for sealants applied into precast concrete joints:
 - Panel edges must be clean, dry and free of any deleterious material that may affect the adhesion of the sealant. The sealant should be allowed to cure without direct exposure to precipitation.
 - Sealant movement capability should be at least 25 per cent or as required by the joint size determined for the specific application.
 - Sealant materials should have demonstrated performance capability, in terms of adhesion and elasticity, after testing for 2,000 – 5,000 hours of ultraviolet, accelerated exposure, according to ASTM C 793.

- Sealant tensile adhesion can be tested in accordance with ASTM C 1135. Adhesion in peel can be tested in accordance with ASTM C 794. Elasticity can be measured by testing in accordance with ASTM D 412.
- Most sealants are manufactured and supplied with compatible proprietary primers. The necessity for primer application can be determined by field testing for sealant adhesion. A simple method for determining the adhesion of a specific sealant for application into a given joint would be to create a construction mock-up (that would incorporate other critical building envelope details), and include a typical sealant joint. Once the sealant is cured, cut the sealant at each side of the joint—100 mm (4 inches) long—and along the top side. Pull out the sealant to review its profile, noting the dimensions. Then pull on the sealant at a 45° angle of incidence from the wall plane. The sealant should not fail in adhesion or cohesion before the sealant reaches its design movement capability.
- Most silicone and polyurethane sealants are suitable for precast concrete panel joints provided they have a medium to low modulus of elasticity. Sealants that have the potential to cause staining tend to be based on silicone, with a high content of oils that can leach out of the joints over time. Sealants are available in various colours, however, the neutral colours tend to provide less noticeable accumulation of dirt and/or fading. Sealant manufacturers should be consulted on the application proposed; they should provide adhesion and stain testing results and warranties.

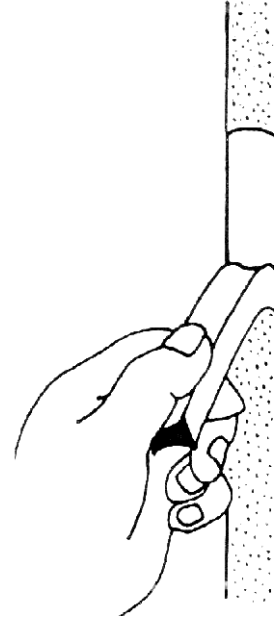

INTERFACE WITH OTHER COMPONENTS

General

Details of the interface between the precast cladding system and adjacent elements need careful consideration to allow for load transfer and deflection, and continuity of drainage, air and vapour barriers, and thermal insulation.

Foundations

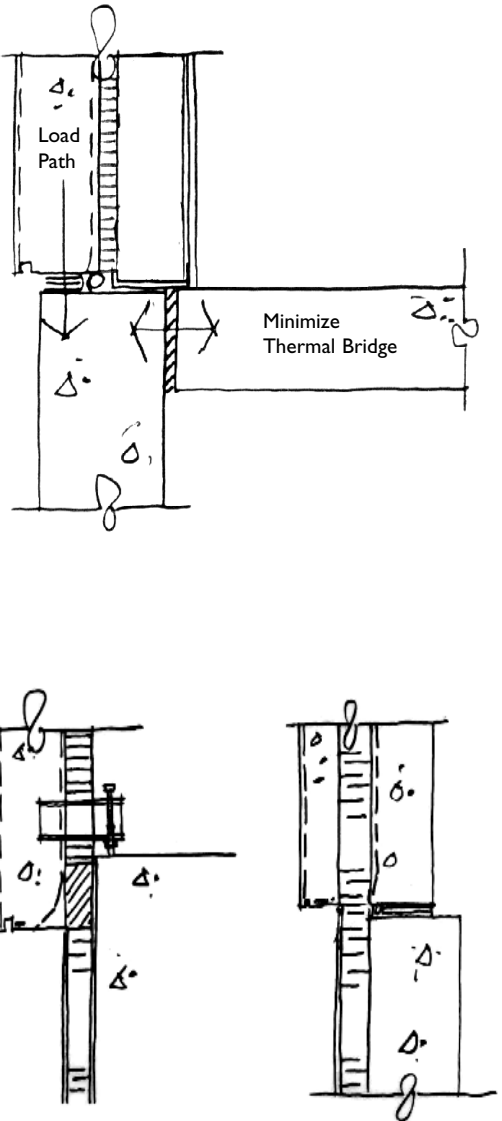

- Direct load transfer to the foundation is most economical. The thermal bridge between the foundation and slab needs to be minimized for condensation control at the perimeter and for comfort. This is unlikely to be a problem at interior relative humidities below 25 per cent and in building locations where the outdoor design temperature is -25°C or above.

Both weather and air seals are recommended for panels mounted in this fashion. The vertical cavities formed between the weather and air seals must be drained at the base of the wall.

- A higher performance but more costly detail, both with respect to drainage and insulation continuity, can be provided by hanging the precast panels clear of the foundation with conventional precast, or bearing the interior wythe of a sandwich panel on the foundation. Insulation continuity is provided at the top of the foundation by two component polyurethane that also provides the air seal.

Windows and Doors

- At windows and doors, the plane of the glass or the door needs to be as near as possible to the plane of the insulation.
- Where two-stage joints are employed, water can be expected at the inner air seal, thus flashing lines must extend back to this plane in the wall.
- Air and vapour barrier connections to closed window and curtainwall sections are best made with membrane materials clamped to the neck and adhered and clamped to the precast. The length of unsupported membrane should not exceed 19 mm (3/4 inch).
- Air and vapour barrier connections to open window sections are most often made with two component polyurethane insulation.

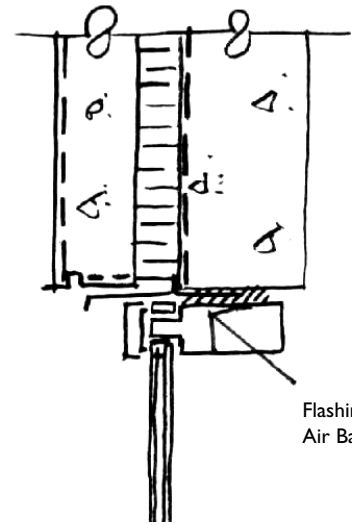

Flashing line and
Air Barrier Line

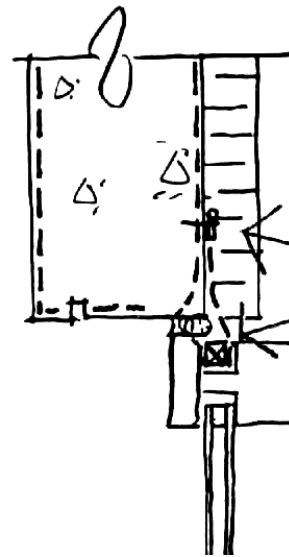

Adhere
and Clamp
Membrane

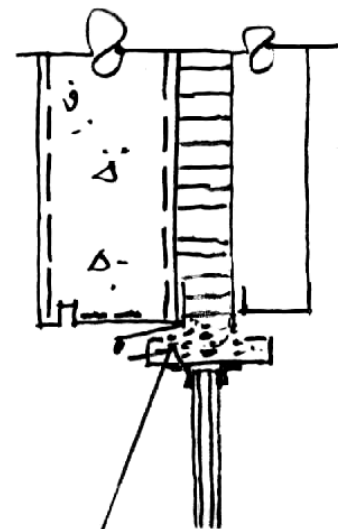

Polyurethane Connection of Windows
to Air and Vapour Barrier

Other Wall Types

Air and Vapour Barrier with Sheet Metal Transition

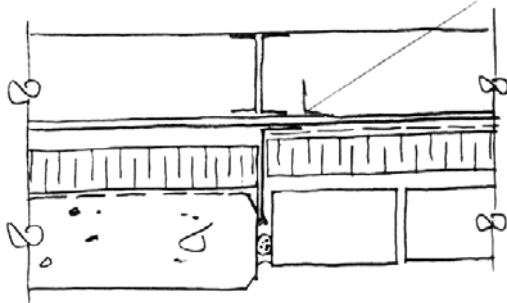

The interface with brick veneer or metal cladding on commercial buildings generally involves a drained cavity with a combined air and vapour barrier membrane on the warm side of the insulation. Sheet metal and gun-applied sealants or tapes are often used in the transition of the plane of the air and vapour barriers (see chapter 4, details 11 and 23).

Roofs and Balconies

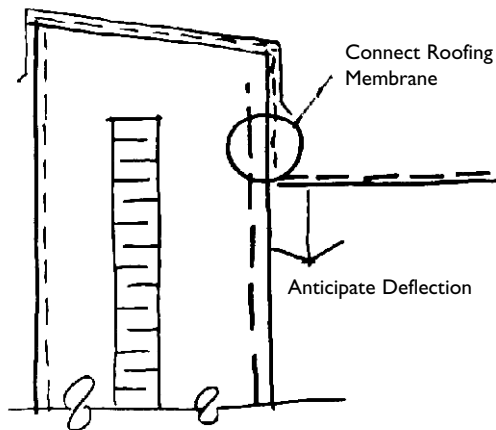

- Roof wall junctions are particularly prone to air and water leakage. The water-tight roofing membrane is also generally the air barrier and must be connected to the line of air tightness in the exterior wall. Deflection of the roof structure due to live loads (ponding water and snow accumulation) must be anticipated in designing this connection.

- The tops of parapets should drain back to the roof to avoid staining exterior precast.

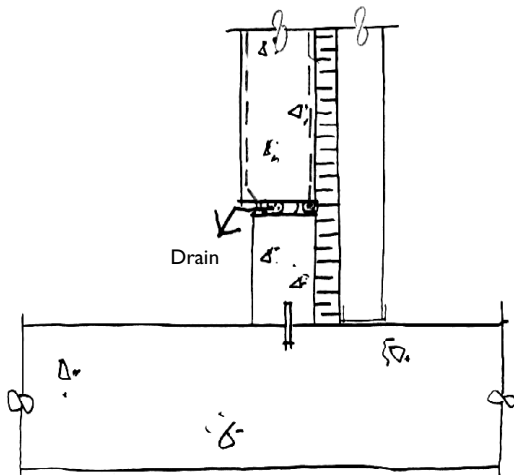

- Wind-driven rain and snow accumulation can lead to water leakage at locations where precast cladding meets balcony slabs or slabs at grade. Upstands of 150 mm (6 inches) in the concrete with integral water stops are recommended.

BUILDING FRAME

The building structure must support precast panels to resist both lateral and vertical forces. The deflection of concrete versus steel frames under short- and long-term loading can vary significantly and it is vital that the design of the panels and panel connections to the building frame respect the anticipated behavior of the frame.

Cast-in-place Concrete

All concrete frames undergo shrinkage over time—which will shorten structural elements—because of the hydration process and drying of the cement matrix. The shortening of the concrete frame will occur at different rates dependant on age (time of curing) and environment (primarily relative humidity of the air). This phenomenon will induce forces at the lateral connections unless the connections are designed to allow the panel to move relative to the frame in the vertical direction.

- Another dimensional change in concrete frames occurs as a result of creep deflection and creep shortening. Creep in concrete occurs as a result of sustained loading and varies with the age of the concrete at the time of loading and the strength of the concrete. It can introduce significant movements and forces on exterior wall components. Creep deflection is a factor with precast panels that are connected to concrete frames at the exterior horizontal slabs or beams. Connections, joint location and joint design must accommodate the anticipated long-term creep. Locating connections near columns will minimize these problems.
- Creep shortening is cumulative and is most significant in high-rise concrete frames. It can cause closing of horizontal joints and compression failure and spalling of exterior precast panels. Connection design and calculation of joint size must recognize the effect of creep shortening.
- The designer must collaborate with the structural design engineer to determine how much concrete frame shortening from shrinkage and creep to accommodate in cladding joint design.

Precast Concrete

- Precast concrete frames are subject to the same affects of load deflection and creep as cast-in-place frames. Creep is generally less of a concern with precast concrete frames compared with cast-in-place concrete, however, since the frame is loaded at higher strength and after the concrete has cured. The behavior of precast frames and the cumulative effects of gravity loads and creep will be different depending on the connections between elements and the number of joints.

Steel

- Steel building frames do not undergo shrinkage or creep. They are inherently lighter and undergo deflection and torsion rotation more readily than concrete frames. This characteristic will have an impact on the design of connections, joints and sizing of architectural precast elements to be supported. Locating connections at or near columns will minimize problems with deflection of steel spandrel beams.

Hybrid

- Some precast panel cladding systems are self supporting for vertical loads with the lateral loads taken by one of the other structural types.

4

CHAPTER FOUR

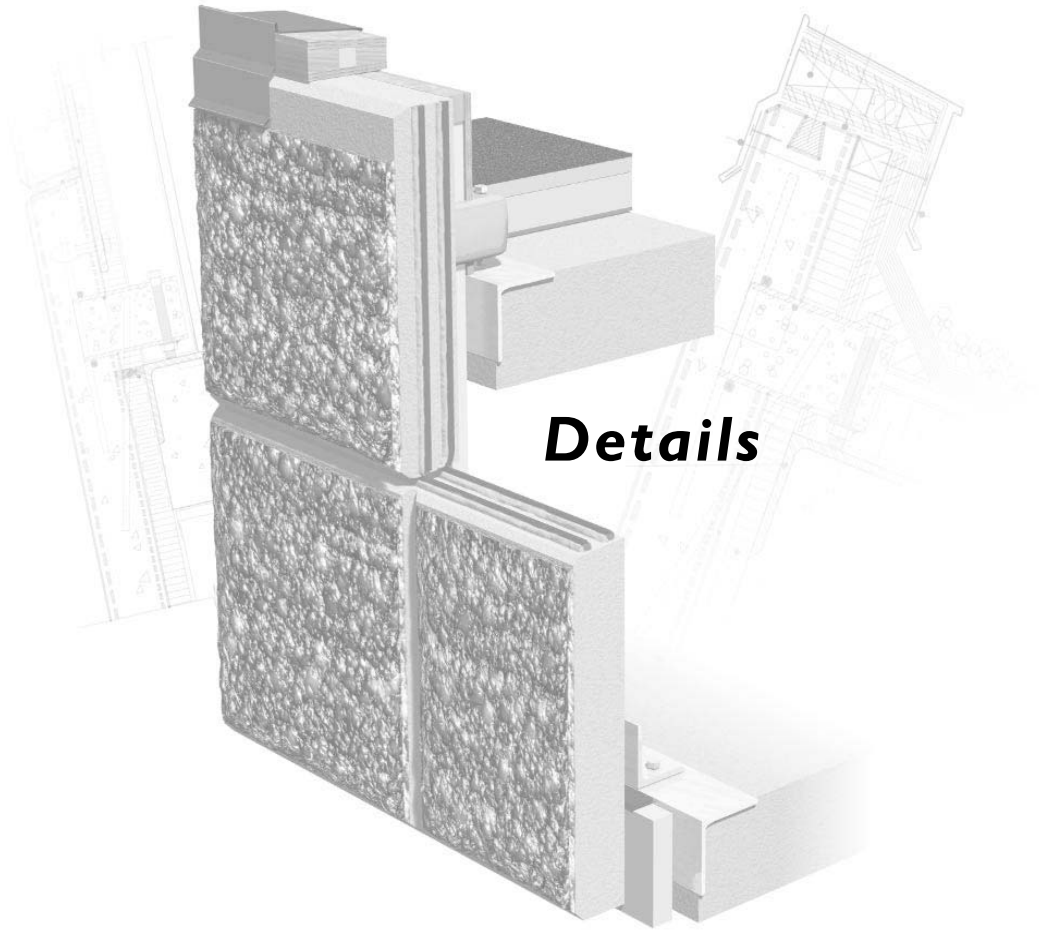

PERFORMANCE REQUIREMENTS

Performance requirements for exterior walls include structural performance, environmental separation, fire performance, durability and aesthetics. Environmental separation involves control of heat, air and moisture flows. These factors depend on the loads that are imposed by the location and the functional program for the building.

The various elements of the wall can work together to achieve the required performance. Minimum acceptable performance for health and safety is set by local building codes. The performance requirements will influence the selection of panel type and design details, and the fabricator's designer and the building's design team should work together to develop the design details.

Structural Performance

- Structural performance includes the structural sufficiency of the panels as well as that of the connections to the building. Structural sufficiency of the panels must be achieved during fabrication, erection, as well as in-service. The fabricator's structural engineer should work in concert with the building's structural engineer to develop the structural connection between the panels and the building.

Issues to be addressed include:

- gravity, wind and seismic loads
- load distribution between outer wythe and inner wythe
- connections from outer wythe to inner wythe to building or ground
- correct load transfer to structure
- accommodation of forces from environmental loads (thermal)
- accommodation of building deflection and creep
- accommodation of loads from other building elements such as windows and window washing rails

Heat Transfer

- Concrete is not a good thermal insulator. Insulation must normally be included in a precast wall assembly to control surface temperature (condensation potential), and rate and quantity of heat flow (load and energy). The insulation system should be designed to provide continuous coverage and especially to minimize thermal bridges since these lead to low surface temperature with high condensation potential.
- Recommendations:
 - Insulation within sandwich panels is generally rigid Type 3 or 4 polystyrene.
 - On conventional precast, rigid polyurethane, polyisocyanurate, or semi-rigid mineral fibre can be specified.
 - When adhering insulation, use a full bed of adhesive or apply in a closed grid pattern to avoid air movement on the cold side.
 - R values should be established based on a cost benefit analysis.

- Commercial buildings tend to be cooling load dominated because the energy input from internal and solar gains frequently exceeds heating requirements. While thermal mass, such as in precast concrete cladding, can shift some excess energy to periods when it could be better utilized; this process is only effective if the temperature of the space is allowed to vary widely. Such variation will have a large negative effect on comfort if it occurs during working hours. Thermal mass can also uncomfortably extend recovery time after system shutdown.

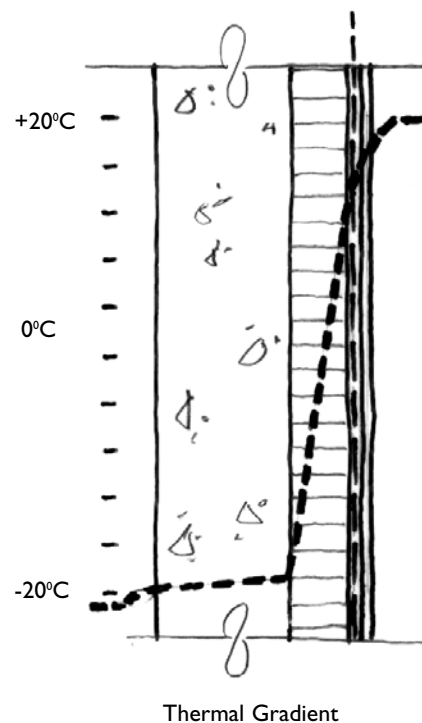

Air Leakage

- Control of air leakage affects many issues including condensation, heating/cooling energy, thermal comfort, rain penetration, smoke movement, and sound transmission. Typically, control of air leakage is achieved with an air barrier system, which is a designed element that has the objective of providing a continuous barrier to the movement of air (NBC'95).
- An air barrier system has the following characteristics:
 - Constructed of airtight materials ($<0.02 \text{ L}/(\text{s}\cdot\text{m}^2)$ @ 75 Pa pressure difference—according to NBC);
 - Continuous within the building envelope (across joints within the assembly and across junctions with other components and assemblies);
 - Structurally sufficient (resist wind load and transfer all loads to the building structure);
 - Durable (provides performance for service life without maintenance).

Architectural precast concrete meets most of these requirements in that it is airtight, structurally sufficient and durable. Continuity within the building envelope is the responsibility of the designer, although the fabricator, either solely or jointly with the design team, may take responsibility for continuity across joints within the assembly.

Vapour Diffusion

- Control of vapour diffusion, which is required to minimize condensation of interior moisture, is essential in high-humidity buildings. A vapour barrier is a material with low vapour permeance that is installed to control vapour diffusion so as to minimize condensation (NBC'95). The vapour barrier must be located where it is warm enough to avoid condensation.

Recommendation:

- A 100 mm (4 inch) thickness of concrete has the necessary water vapour permeance ($45 \text{ Ng}/\text{Pa}\cdot\text{s}\cdot\text{m}^2$) and can be the vapour barrier if warm enough.

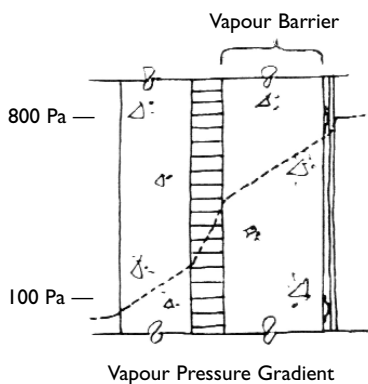

Adequate Vapour Diffusion Protection by Structural Wythe at Concrete

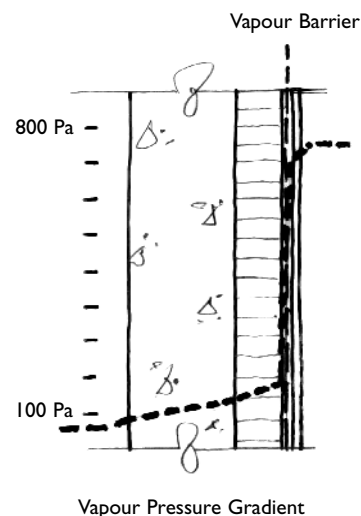

Precipitation

- Failure to manage precipitation infiltration, both rain and snow, can have both immediate—for example, liquid water in the interior space—and long-term—for example, reduced service life—consequences.
- Architectural precast concrete has an inherent benefit in rain penetration control in that the concrete absorbs little water, and the thickness used for precast panels tends to stop water ingress in the field of the panel.
- Two-stage, (rainscreen) joints between panels and rainscreen junctions with other assemblies are required to complement the performance inherent in the field of the panels. Horizontal surfaces must be designed with a positive slope to ensure runoff of rain and melting snow.
- Design strategies to control rain penetration include:
 - Face-sealed systems locate the weather barrier at the exterior face of the assembly. Face-sealed walls depend on continual maintenance of the joints for long-term performance and are not recommended.
 - Rainscreen systems incorporate a second line of defense behind the weather barrier. Rainscreen walls provide better and more consistent performance over the long term.

Fire Performance

The fire performance of precast panels is usually not a concern since concrete is noncombustible. However, by regulation, fire stopping must be installed to prevent fire and smoke transmission between floors, and combustible insulation must be covered by fire-rated assemblies. This applies not only to the panels, but also to the joints between panels. At the time of publication, Canadian Building Codes do not require fire protection of precast anchors.

Noise / Acoustics

- Noise separation becomes an important design issue when the building is located next to a source such as an airport or busy highway. Typical concrete elements are sufficiently massive to form effective elements in a sound insulation design.
- The sound transmission of a wall is largely determined by the performance of the windows and doors, and by the air tightness of the assembly. Windows and doors can be designed for improved sound insulation, but only if they are kept closed.
- An air barrier system will have a positive effect on the sound insulation of the assembly.
- A 100-mm (4-inch) thick concrete wall panel has an STC (sound transmission class) of 50, which is the minimum STC required between dwelling units by the National Building Code (NBC).
- Adding insulation and gypsum board raises the STC further, such that a precast concrete assembly can easily be designed to exceed this value.

Durability

- Concrete resists weathering, and prefabrication provides an opportunity for precast panels to be designed for long term durability.
- Durability issues to be considered include:
- freeze/thaw resistance of the concrete
 - weathering of the finish
 - corrosion of the reinforcing steel
 - joint sealant performance
 - glass etching from water runoff
 - access for maintenance

Aesthetics

The aesthetics of the building façade is the responsibility of the designer, usually an architect, and is achieved in concert with the precast supplier. Architectural precast offers design flexibility because of concrete's plasticity with a wide range of shapes, colours and finishes. The aesthetic choices are wide and varied (see Chapter 2). The fundamental nature of concrete and the process introduces some constraints including:

- maximum mass and dimensions limited by transportation and erection
- minimum dimensions limited by structural sufficiency
- capital cost of moulds requires repetition of design to reduce unit cost

DETAILS OVERVIEW

Details have been developed to illustrate design approaches that address the performance requirements discussed above. They do not address all possible situations that may arise; rather they include a selection of precast panel types and junctions that can occur on buildings. These details illustrate the application of the design principles previously discussed. The designer can determine the details required for their specific application from an analysis of those illustrated here.

The particular design parameters are arbitrary. An actual building design would require an analysis of its unique set of conditions. Each building has a different combination of interior environment, exterior exposure, desired aesthetics and service life, all of which have an impact on its design. One common feature is that the design must be buildable, which means that the sequence of construction must be considered as part of the design procedure.

The following parameters are common to all details:

- The panels are non-load bearing.
- The panels are assembled with two-stage joints, which consist of a “weather seal” installed at the exterior of conventional panel joints or between the architectural wythes of sandwich panels, and an “air seal” installed at the interior of conventional panel joints or between the structural wythes of sandwich panels. The line of the weather seal and air seals in the panel joints beyond is shown as a dotted line in each section.
- Generally, the “weather seal” and “air seal” are installed from the exterior unless continuity problems around columns, floors and anchors can be avoided allowing installation from the interior.
- The drawings are “exploded” to clarify the different elements.

General

The PRECAST PANEL is bearing on the top of the CONCRETE FOUNDATION. A DOWEL is inserted into the FOUNDATION after PRECAST PANEL erection to provide a lateral connection. The SHIMS support and true the PANEL.

Thermal Barrier

The thermal barrier is provided by the SEMI-RIGID INSULATION adhered on the backface of the PRECAST PANEL.

Air Barrier

The air barrier is provided by the PRECAST PANEL. Air barrier continuity between PANELS is provided by the AIR SEAL installed in line with the interior face of the PANELS, and continuity at the foundation is provided by sealant installed at the base of the panel. The AIR SEAL must be continuous with no interruptions because the steel stud wall is not designed to support the wind load.

Vapour Barrier

The vapour barrier is provided by the facing on the SEMI-RIGID INSULATION.

Precipitation

Control of precipitation is provided by the PRECAST PANELS, in combination with the two-stage joint between PANELS. The cavity in the joint between the WEATHER SEAL and AIR SEAL is drained to the exterior at the base of the joint.

Other Considerations

Panel erection and alignment with this system is fast because all the connection locations are open with good accessibility prior to the application of the interior wall and finishes. The building can be enclosed quickly and electrical services can be accommodated in the steel stud walls.

Construction Sequence

- Precast panels, shim to suit
- Drilling and installation of steel dowel
- Air seal and weather seal at precast joints
- Insulation on back of precast panel
- Steel studs and drywall

Detail 1

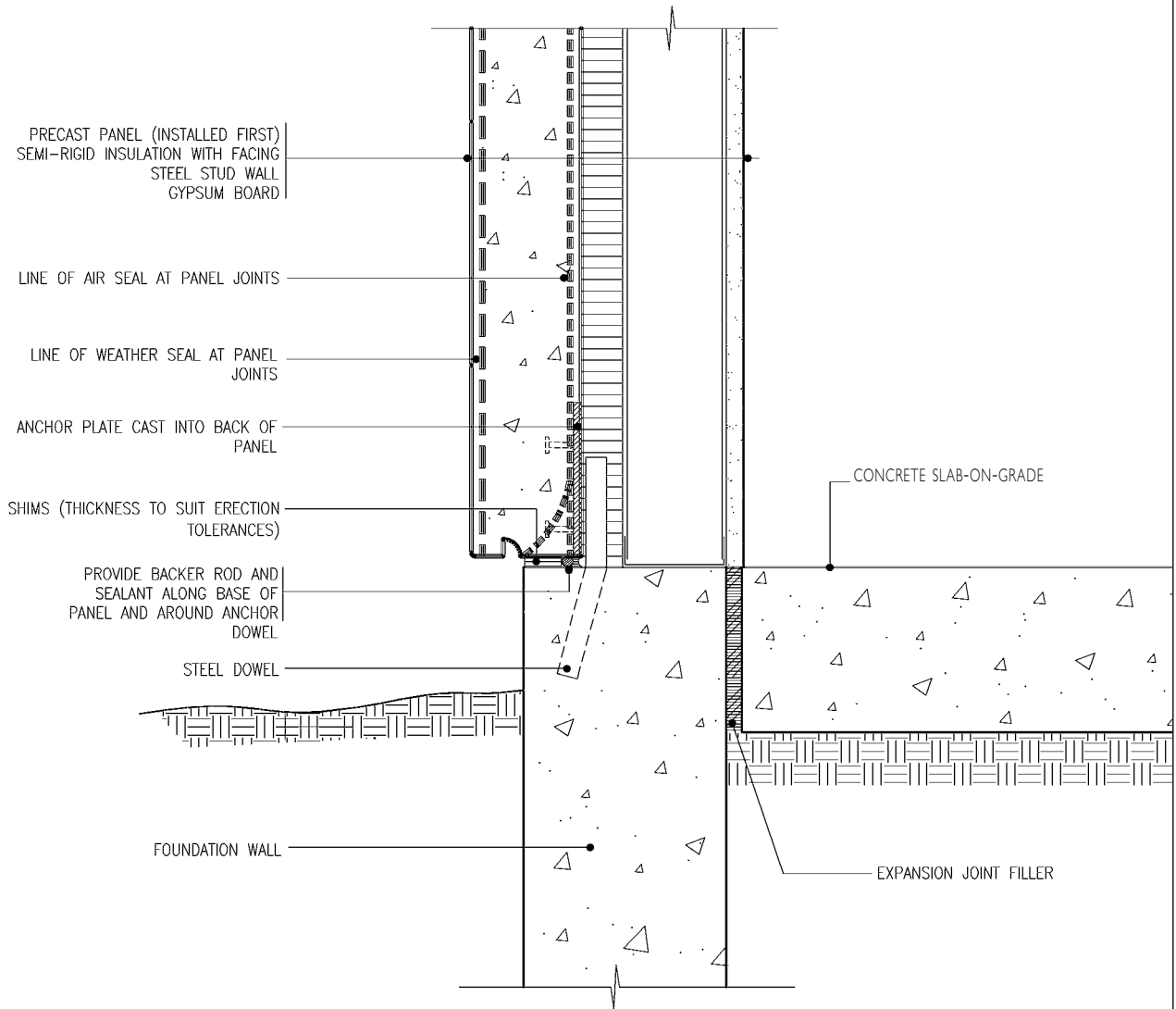

CONVENTIONAL PANEL
BOTTOM BEARING AND LATERAL FOUNDATION CONNECTION

BEST PRACTICE GUIDE
ARCHITECTURAL PRECAST CONCRETE WALLS

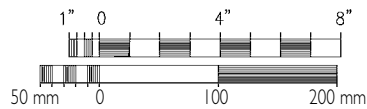

- General** The conventional PRECAST PANEL system is hung from the FLOOR SLAB above and is retained laterally with a slotted bracket secured to the slab. It is assembled with a two-stage joint.
- Thermal Barrier** The thermal barrier is provided by the SEMI-RIGID INSULATION, which is field-installed on the PRECAST PANEL. The line of insulation is continued down the face of the foundation. This assembly provides improved thermal performance and condensation resistance compared with detail I. The STEEL STUD WALL may be insulated depending on R-value requirements.
- Air Barrier** The air barrier is provided by the PRECAST PANEL. Air barrier continuity between PANELS is provided by the AIR SEAL installed in line with the back face of the PANELS, and continuity at the foundation is provided by urethane foam or sealant. The AIR SEAL must be continuous with no interruptions and must connect with the air seal on other building assemblies.
- Vapour Barrier** A vapour barrier is integral with the back of the adhered INSULATION. When insulation is installed in the STEEL STUD WALL, the vapour barrier may be moved to the interior of the STEEL STUD WALL.
- Precipitation** Control of precipitation is provided by the PRECAST PANEL, in combination with the two-stage joint between PANELS. The cavity in the joint between the WEATHER SEAL and AIR SEAL is drained to the exterior at the base of the joint, and a drip prevents runback of rainwater at the base of the PANELS.
- Other Considerations** This system provides an economical enclosure. Panel erection and alignment with this system is fast because all the connection locations are open with good accessibility prior to the application of interior insulation and finishes. The building can be enclosed quickly and electrical services can easily be accommodated in the steel stud walls.
- Construction Sequence**
- Precast panels and connections
 - Air seal and weather seal
 - Insulation on back of separate precast panels
 - Urethane foam air seal to foundation
 - Foundation insulation and interior steel stud and drywall

Detail 2

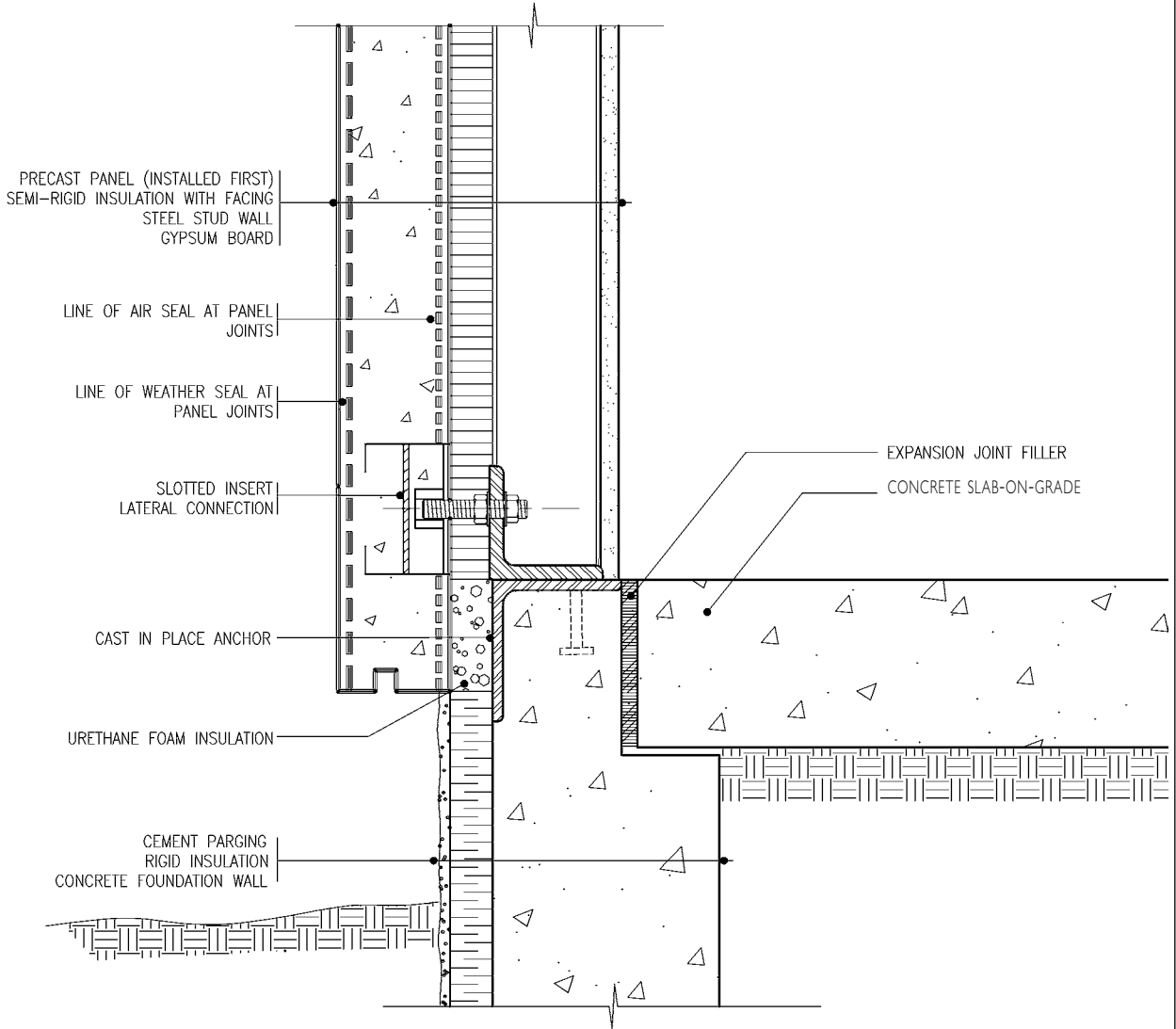

CONVENTIONAL PANEL
LATERAL FOUNDATION CONNECTION

BEST PRACTICE GUIDE
ARCHITECTURAL PRECAST CONCRETE WALLS

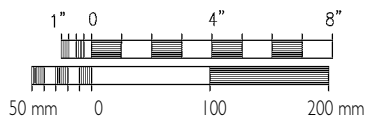

General

The PRECAST PANEL is hung from the floor slab above and provided with a lateral support to the floor slab forming the soffit. The panel is installed with two-stage joints. The PRECAST PANEL is spaced off the main structure to allow for construction tolerances. The soffit is designed as a “cold soffit”, for example, the soffit space is outside the conditioned space.

Thermal Barrier

The thermal barrier is provided by the SEMI-RIGID INSULATION on the back of the panel, RIGID INSULATION on the FLOOR SLAB, and the INSULATED METAL PANEL. The RIGID INSULATION must be in intimate contact with the underside of the FLOOR SLAB to avoid convective airflow that would render it ineffective.

Air Barrier

The air barrier is provided by the PRECAST PANEL, FLOOR SLAB and INSULATED METAL PANEL. Air barrier continuity between PANELS is provided by the AIR SEAL installed in line with the back face of the PANELS. Self-levelling air seal provides continuity between the PRECAST PANEL and the FLOOR SLAB. The SELF-ADHERED BITUMINOUS MEMBRANE provides continuity between the FLOOR SLAB and INSULATED METAL PANEL.

Vapour Barrier

The vapour barrier is provided by the facing on the SEMI-RIGID INSULATION, and the vapour barrier function is provided by the FLOOR SLAB and INSULATED METAL PANEL.

Precipitation

Control of precipitation is provided by the PRECAST PANELS, in combination with the two-stage joint between PANELS. The cavity in the joint between the WEATHER SEAL and AIR SEAL is drained to the exterior at the base of the joint.

Other Considerations

Panel erection and alignment with this system is fast because all the connection locations are open with good accessibility prior to the application of the interior wall and finishes. The building can be enclosed quickly and electrical services can be accommodated in the steel stud walls.

Construction Sequence

- Semi-rigid insulation to slab edge
- Precast panels
- Air seal and weather seal
- Air seal connection to slab edge
- Insulation on back of panel
- Steel studs and drywall
- Soffit details

Detail 3

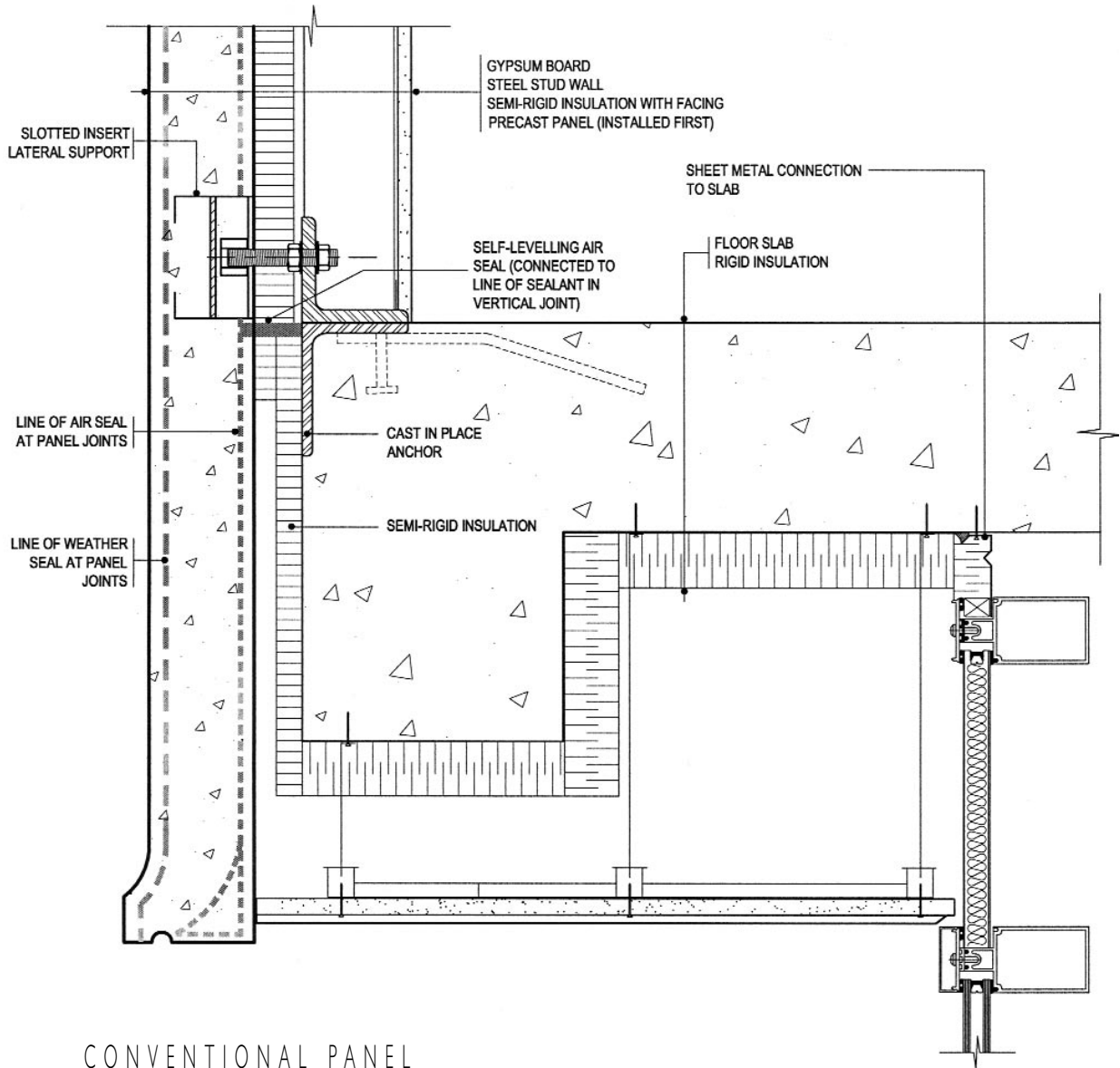

CONVENTIONAL PANEL
SUSPENDED SOFFIT

BEST PRACTICE GUIDE
ARCHITECTURAL PRECAST CONCRETE WALLS

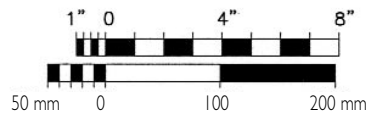

General

The insulated conventional PRECAST PANEL system is hung from the FLOOR SLAB and the panel above is retained laterally by the SLOTTED ANCHOR PLATE across the horizontal panel joint. It is assembled with a two-stage joint.

Thermal Barrier

The thermal barrier is provided by the SEMI-RIGID INSULATION, which is field-installed on the PRECAST PANEL and on the face of the CONCRETE FLOOR SLAB. The STEEL STUD WALL may be insulated depending on R-value requirements.

Air Barrier

The air barrier is provided by the PRECAST PANEL. Air barrier continuity between PANELS is provided by the AIR SEAL installed in line with the back face of the PANELS, and continuity at the slab edge is provided by the SMOKE SEAL AND FIRE STOP. The AIR SEAL must be continuous with no interruptions and connect to the air seal on other building assemblies.

Vapour Barrier

A vapour barrier is integral with the back of the adhered INSULATION. The vapour barrier may be moved to the interior of the STEEL STUD WALL when insulation is installed in the STEEL STUD WALL.

Precipitation

Control of precipitation is provided by the PRECAST PANELS, in combination with the two-stage joint between PANELS. The cavity in the joint between the WEATHER SEAL and AIR SEAL is drained to the exterior at the base of the joint.

Other Considerations

This system provides an economical enclosure. Panel erection and alignment with this system is fast because all the connection locations are open with good accessibility prior to the application of interior insulation and finishes. The building can be enclosed quickly and electrical services can easily be accommodated in the steel stud walls.

Construction Sequence

- Semi-rigid mineral fibre to slab edge
- Precast panels
- Air seal and weather seal
- Air seal connection to panel edge
- Insulation on back of panel
- Steel studs and drywall

Detail 4

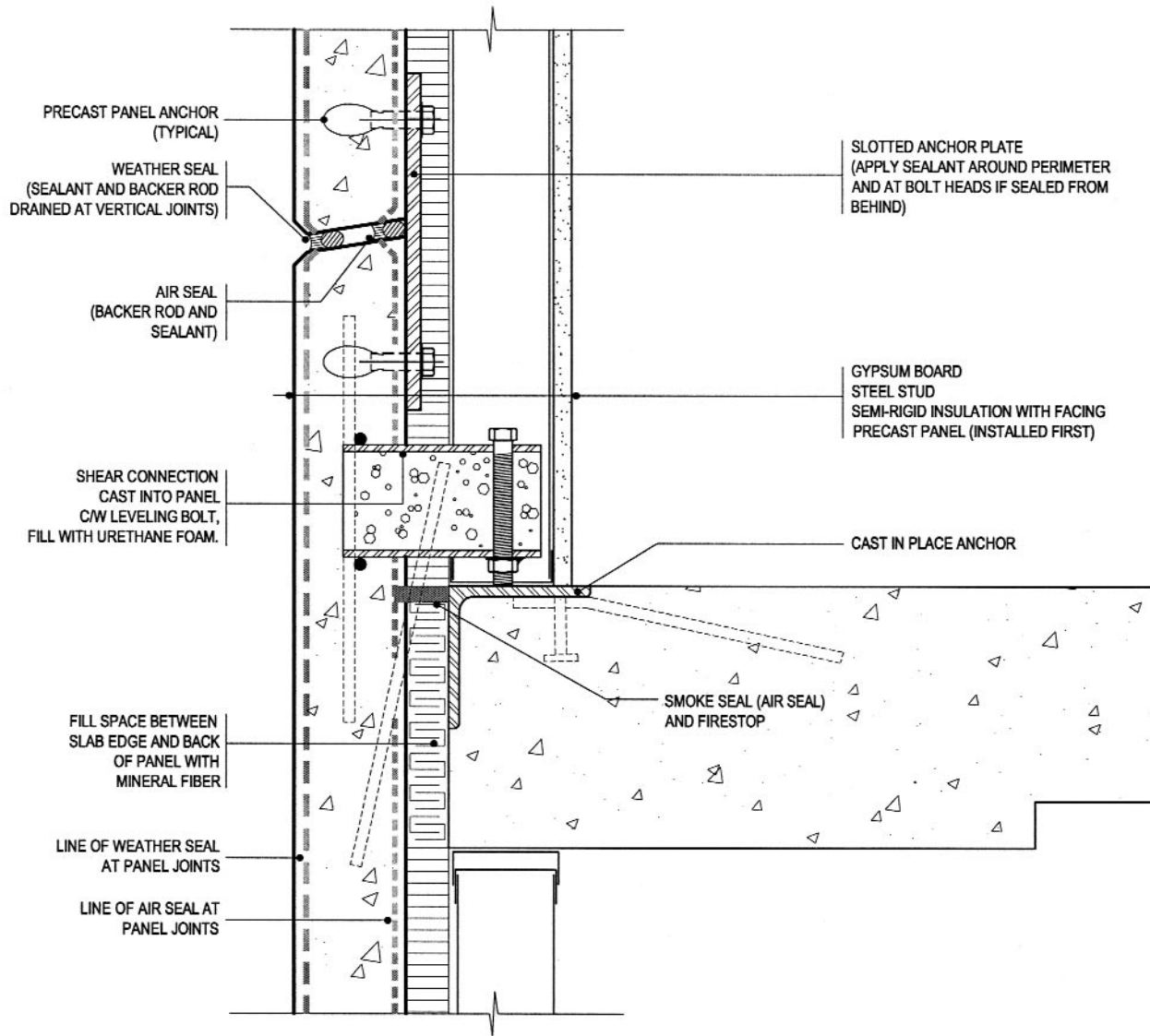

CONVENTIONAL PANEL
SLAB BEARING CONNECTION

BEST PRACTICE GUIDE
ARCHITECTURAL PRECAST CONCRETE WALLS

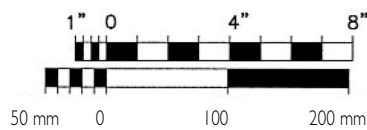

5. Conventional Panel

TOP HUNG PARAPET CONNECTION

General

The insulated conventional PRECAST PANEL system is hung from the ROOF SLAB where it also forms the parapet. It is assembled with a two-stage joint.

Thermal Barrier

The thermal barrier is provided by the SEMI-RIGID INSULATION that is field-applied on the PRECAST PANEL. The thermal barrier on the ROOF DECK is provided by the RIGID INSULATION.

Air Barrier

The air barrier is provided by the PRECAST PANEL and the BUILT-UP ROOF. Air barrier continuity between PANELS is provided by the AIR SEAL installed in line with the back face of the PANELS. The AIR SEAL must be continuous with no interruptions and must connect to the air seal on other building assemblies. Continuity between the PRECAST PANEL and the BUILT-UP ROOF is provided by the BITUMINOUS MEMBRANE.

Vapour Barrier

A vapour barrier is integral with the back of the adhered INSULATION. The vapour barrier may be moved to the interior of the STEEL STUD WALL when insulation is installed in the STEEL STUD WALL. The vapour barrier in the ROOF is a mopped on single-ply felt.

Precipitation

Control of precipitation is provided by the PRECAST PANELS, in combination with the two-stage joint between PANELS. The cavity in the joint between the WEATHER SEAL and AIR SEAL is drained to the exterior at the base of the joint. The BUILT-UP ROOF provides water tightness for the roof and terminates under the ASPHALT FELT FLASHING installed to the parapet.

Construction Sequence

- Semi-rigid mineral fibre to roof slab edge
- Precast panels
- Parapet insulation, roofing and bituminous membrane over parapet
- Air seal and weather seal
- Insulation on back of panel
- Steel studs and drywall

Detail 5

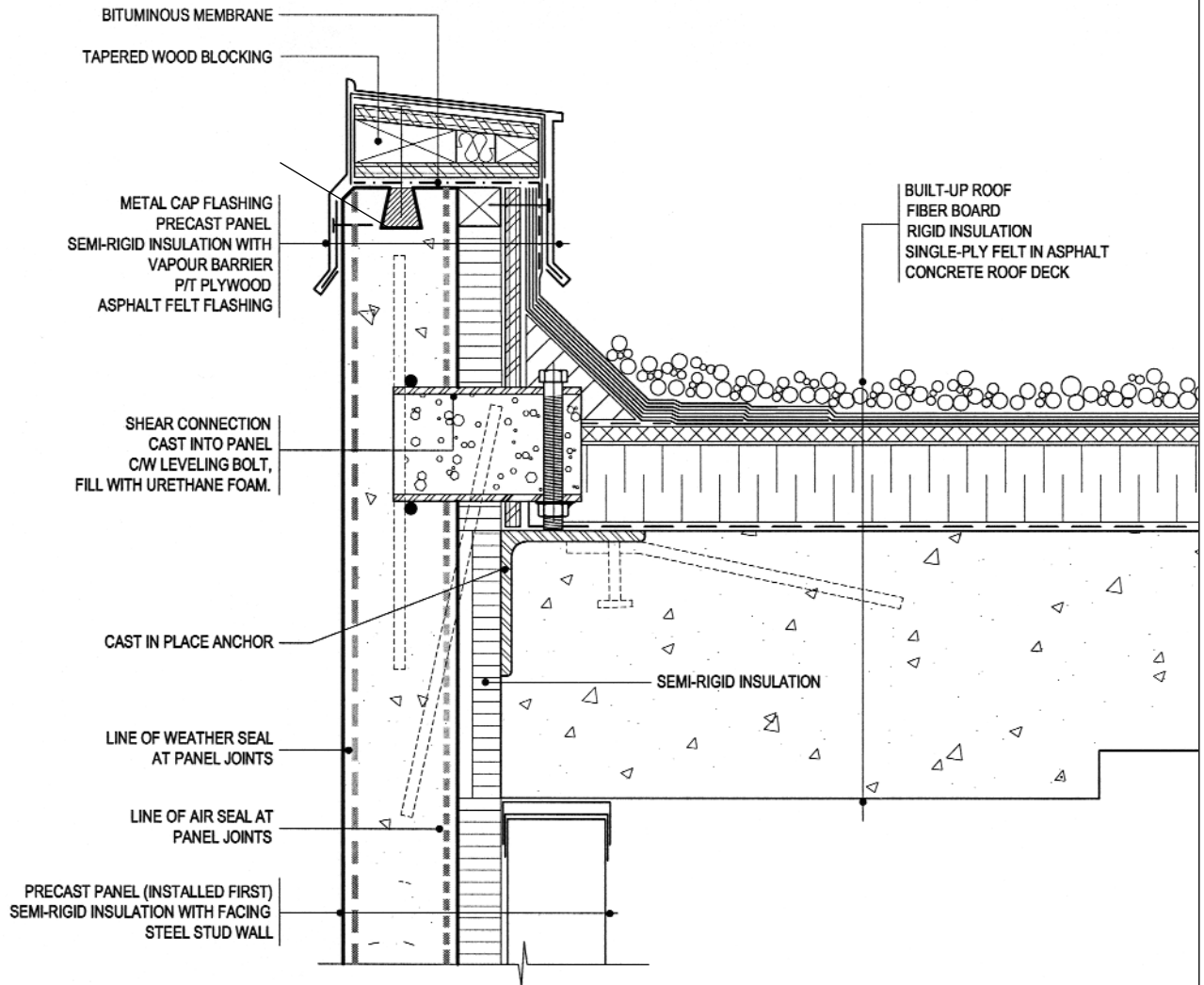

CONVENTIONAL PANEL
TOP HUNG PARAPET CONNECTION

BEST PRACTICE GUIDE
ARCHITECTURAL PRECAST CONCRETE WALLS

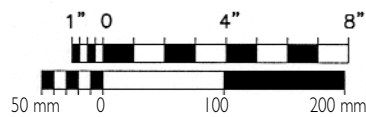

General

The PRECAST PANEL bears on the slab below and is retained laterally by the ROOF SLAB where it also forms the parapet. It is assembled with a two-stage joint. The PRECAST PANEL is spaced off the main structure to allow for construction tolerances.

Thermal Barrier

The thermal barrier is provided by the SEMI-RIGID INSULATION adhered to the back of the panel and the slab edge. The thermal barrier on the ROOF DECK is provided by the RIGID INSULATION.

Air Barrier

The air barrier is provided by the PRECAST PANEL and the BUILT-UP ROOF. Air barrier continuity between PANELS is provided by the AIR SEAL installed in line with the back face of the PANELS. The AIR SEAL must be continuous with no interruptions and connect to the air seal on other building assemblies. Continuity between the PRECAST PANEL and the BUILT-UP ROOF is provided by the BITUMINOUS MEMBRANE.

Vapour Barrier

The vapour barrier is provided by the faced SEMI-RIGID INSULATION adhered to the panels. The vapour barrier in the ROOF is a mopped on single-ply felt.

Precipitation

Control of precipitation is provided by the PRECAST PANELS, in combination with the two-stage joint between PANELS. The cavity in the joint between the WEATHER SEAL and AIR SEAL is drained to the exterior at the base of the joint. The BUILT-UP ROOF provides water tightness for the roof and terminates under the ASPHALT FELT FLASHING installed to the parapet.

Construction Sequence

- Semi-rigid insulation to roof slab edge
- Precast panels
- Parapet insulation, roofing and bituminous membrane over parapet
- Air seal and weather seal at precast joints
- Insulation on back of precast panels
- Steel studs and drywall
- Connect air seal to membrane on parapet

Detail 6

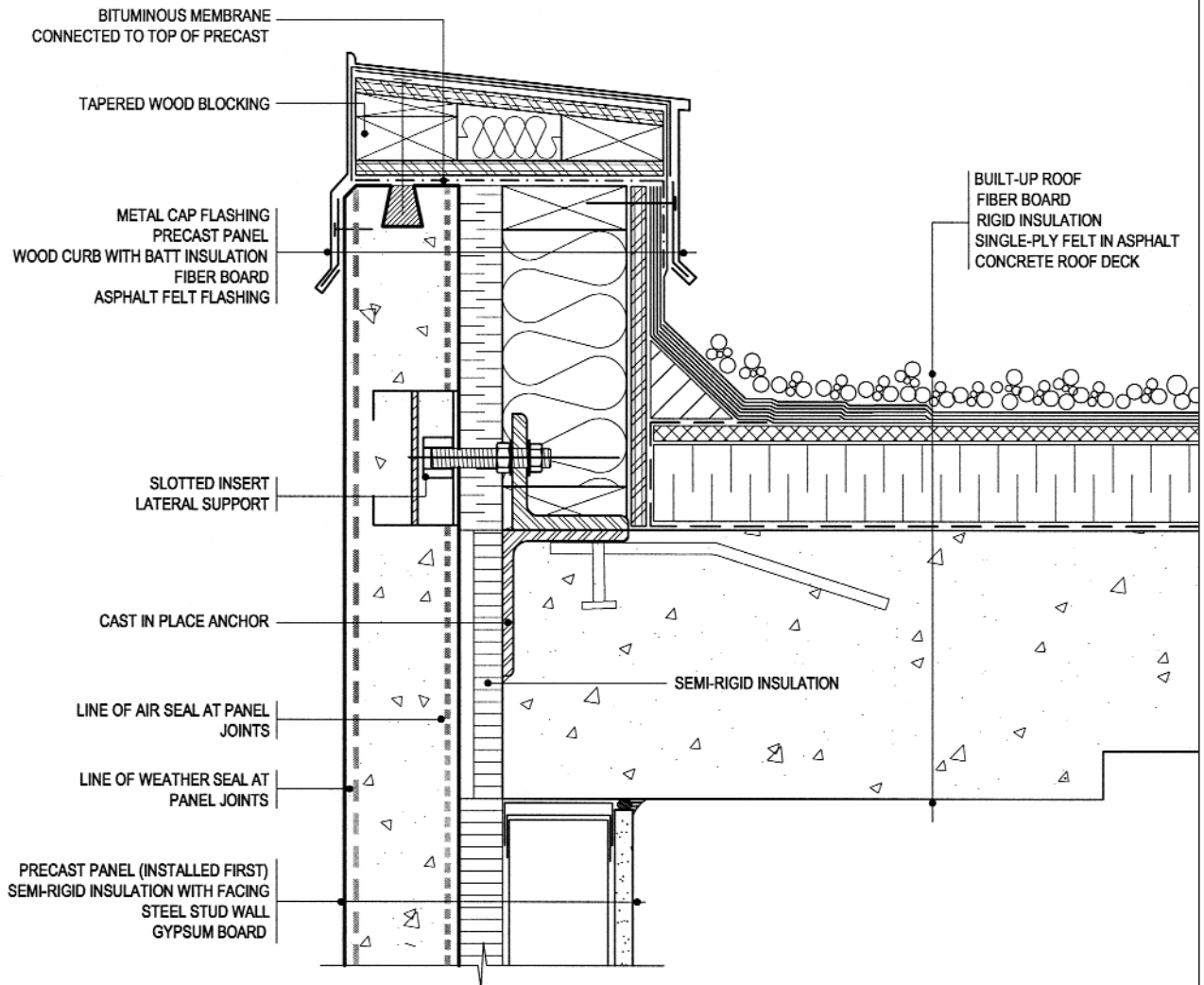

CONVENTIONAL PANEL
LATERAL CONNECTION AT PARAPET

BEST PRACTICE GUIDE
ARCHITECTURAL PRECAST CONCRETE WALLS

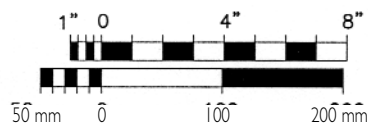

General

The PRECAST PANEL is installed with two-stage joints. The window is connected to the PRECAST PANEL and sealed into an opening with URETHANE FOAM. This detail presents a head and sill connection for a punched WINDOW.

Thermal Barrier

The thermal barrier is provided by the SEMI-RIGID INSULATION, and the frame and double-glazing of the window. Continuity of the thermal barrier is provided by all elements being installed in the same plane.

Air Barrier

The air barrier is provided by the PRECAST PANEL, and the frame and glazing of the window. The inner seal of the two-stage joint provides continuity between panels, and the URETHANE FOAM provides continuity between the window opening and window frame.

Vapour Barrier

The vapour barrier is provided by the facing on the SEMI-RIGID INSULATION, and the vapour barrier function is provided by the metal frame and glazing of the WINDOW.

Precipitation

Control of precipitation is provided by the PRECAST PANELS, in combination with the two-stage joint between PANELS. The BITUMINOUS MEMBRANE finishes the head of the window opening, and a drip cast into the head of the PRECAST PANEL opening prevents run back to the window. The BITUMINOUS MEMBRANE WITH END DAM finishes the sill of the window opening; the sloped sill directs water from the glazing away from the windowsill, and the drip and overhang below the sill directs water off the wall.

Other Considerations

The window load is carried by the PRECAST PANEL. Windows can be installed in a number of ways. Punched windows are installed within precast panel openings, while strip windows are installed on the building as rows (or strips) located between rows of precast spandrel panels. With strip windows, the design must ensure that frame shortening doesn't transfer structural load to the windows, and that vertical joints in the panels that intersect the window head/sill are properly addressed.

Construction Sequence

- Precast panels
- Angles to back of precast for attachment of windows
- Insulation on back of precast
- Steel studs
- Bituminous membranes
- Windows
- Air seal and weather seal on precast
- Urethane foam insulation between window and air seal
- Drywall

Detail 7

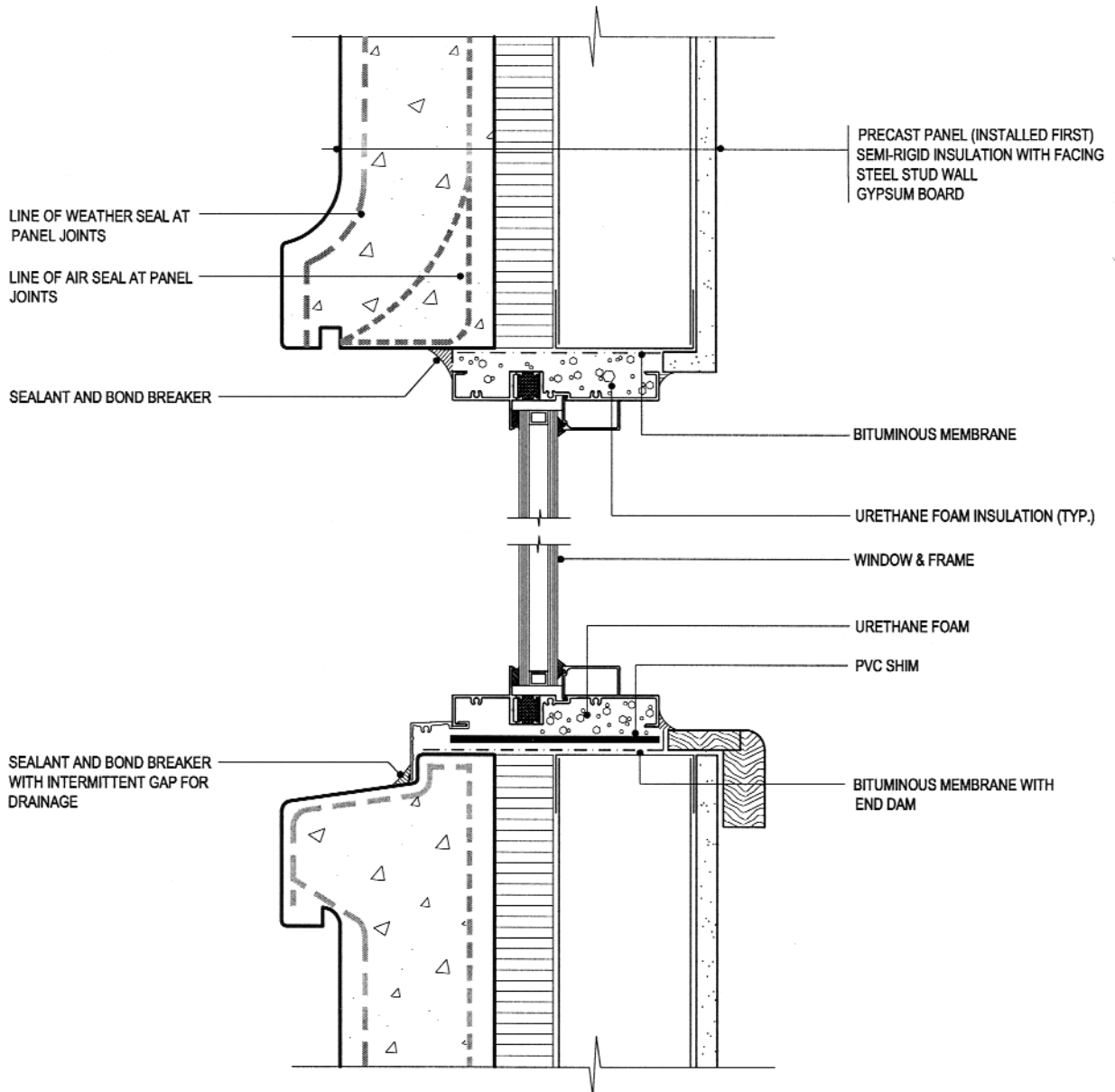

CONVENTIONAL PANEL
WINDOW HEAD/SILL CONNECTION

BEST PRACTICE GUIDE
ARCHITECTURAL PRECAST CONCRETE WALLS

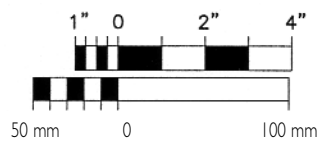

General

The PRECAST PANEL is installed with two-stage joints. The window is connected to the PRECAST PANEL and sealed into an opening with URETHANE FOAM. This detail presents a jamb connection for a punched WINDOW.

Thermal Barrier

The thermal barrier is provided by the SEMI-RIGID INSULATION and the frame and double-glazing of the window. Continuity of the thermal barrier is provided by all elements being installed in the same plane.

Air Barrier

The air barrier is provided by the PRECAST PANEL and the frame and glazing of the window. The inner seal of the two-stage joint provides continuity between panels, and the URETHANE FOAM provides continuity between the window opening and window frame.

Vapour Barrier

The vapour barrier is provided by the facing on the SEMI-RIGID INSULATION, and the vapour barrier function is provided by the metal frame and glazing of the WINDOW.

Precipitation

Control of precipitation is provided by the PRECAST PANELS in combination with the two-stage joint between PANELS. The BITUMINOUS MEMBRANE finishes the jamb of the window opening.

Other Considerations.

The window load is carried by the PRECAST PANEL. Windows can be installed in a number of ways. Punched windows are installed within precast panel openings, while strip windows are often installed on the building as rows (or strips) located between precast column covers.

Construction Sequence

- Precast panels
- Angles to back of precast for attachment of windows
- Insulation on back of precast
- Steel studs
- Bituminous membrane
- Windows
- Air seal and weather seal on precast
- Urethane foam insulation between window and air seal
- Drywall

Detail 8

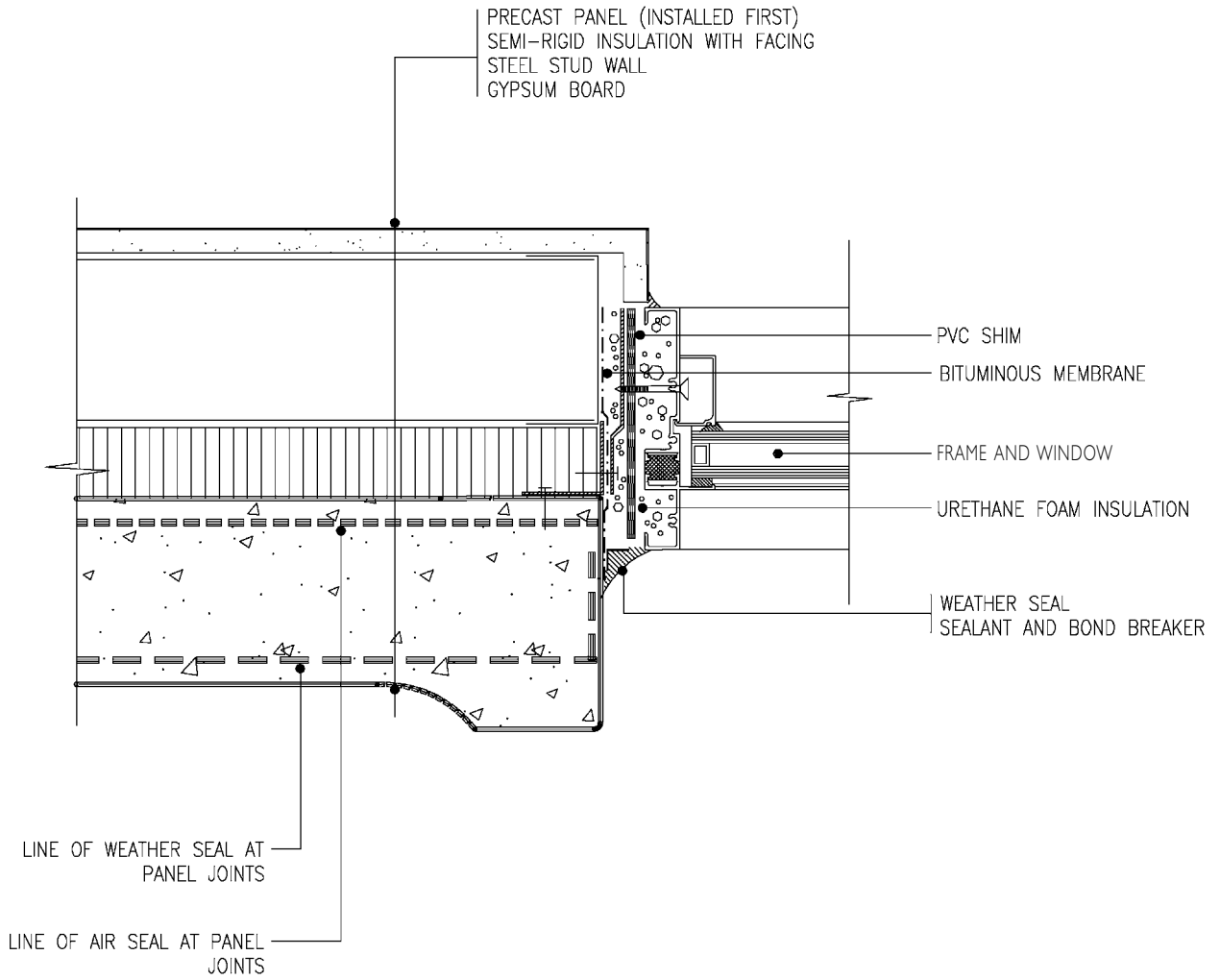

CONVENTIONAL PANEL
WINDOW JAMB TO PRECAST PANEL

BEST PRACTICE GUIDE
ARCHITECTURAL PRECAST CONCRETE WALLS

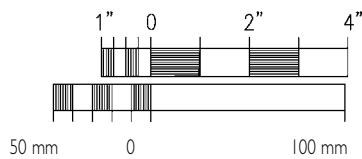

General

The insulated conventional PRECAST PANEL system is assembled with a two-stage joint. The CURTAIN WALL is erected after precast erection. It is a design imperative to maintain continuity of building science performance across the junction between PRECAST PANEL and CURTAIN WALL.

Thermal Barrier

The thermal barrier is provided by the SEMI-RIGID INSULATION that is field-installed on the PRECAST PANEL. The thermal barrier in the CURTAIN WALL is provided by the insulated glass units and thermal break in the mullion.

Air Barrier

The air barrier is provided by the PRECAST PANEL. Air barrier continuity between PANELS is provided by the AIR SEAL installed in line with the back face of the PANELS. Continuity to the jamb of the CURTAIN WALL is provided by the SEALANT connection between the precast and curtain wall. The AIR SEAL must be continuous with no interruptions and marry with the air seal on other building assemblies.

Vapour Barrier

The vapour barrier is provided by the FACING on the INSULATION adhered to the PRECAST PANEL. Vapour diffusion control within the CURTAIN WALL is provided by the inner surfaces of the aluminum and glass.

Precipitation

Control of precipitation is provided by the PRECAST PANELS, in combination with the two-stage joint between PANELS. The insulated glass units deflect most precipitation at the CURTAIN WALL. Rainscreen glazing rabbits drain to the exterior. A WEATHER SEAL at the junction between the PRECAST PANEL and CURTAIN WALL is provided by a sheet metal closure.

Construction Sequence

- Precast panels
- Air seal and weather seal on precast
- Insulation on back of precast
- Curtain wall
- Urethane foam insulation air seal connection between curtain wall and precast
- Weather seal between curtain wall and precast
- Steel studs and drywall

Detail 9

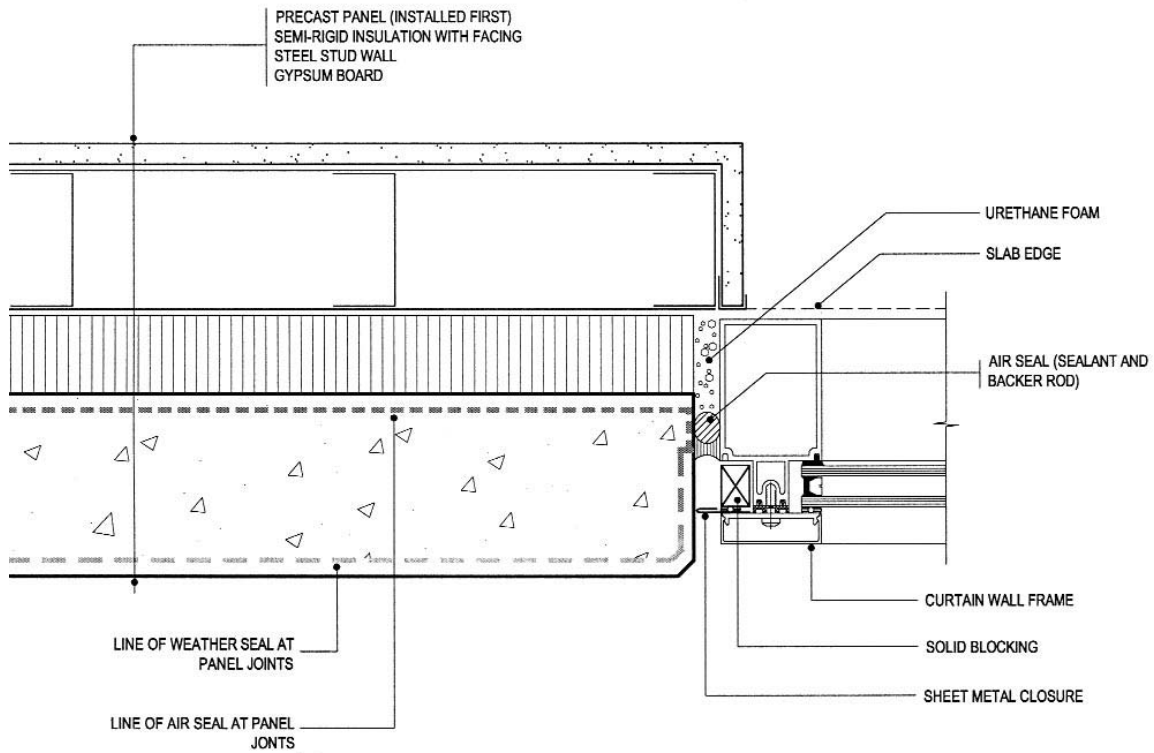

CONVENTIONAL PANEL
JUNCTION WITH CURTAIN WALL (JAMB)

BEST PRACTICE GUIDE
ARCHITECTURAL PRECAST CONCRETE WALLS

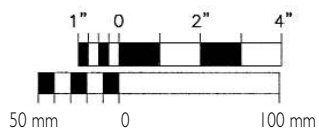

General	The PRECAST PANEL system is installed with a two-stage joint. The STEEL STUD back-up wall is installed after precast erection and installation of adhered insulation.
Thermal Barrier	The thermal barrier is provided by SEMI-RIGID INSULATION on the PRECAST PANEL and by RIGID INSULATION on the face of the CONCRETE COLUMN. The thermal barrier in the STUCCO clad wall is provided by RIGID INSULATION on the outside of the BITUMINOUS MEMBRANE. The STEEL STUD WALL behind the stucco may be insulated depending on R-value requirements.
Air Barrier	The air barrier is provided by the PRECAST PANEL. Air barrier continuity between PANELS is provided by the AIR SEAL installed in line with the interior face of the PANELS. The air barrier within the STUCCO clad wall is provided by the BITUMINOUS MEMBRANE adhered on the EXTERIOR SHEATHING, and continuity with the PRECAST PANEL is provided by adhering the MEMBRANE to the edge of the PRECAST PANEL. At the location where the BITUMINOUS MEMBRANE crosses the cavity, it is adhered to and supported by METAL FLASHING.
Vapour Barrier	The vapour barrier is provided by the facing on the SEMI-RIGID INSULATION adhered to the PRECAST PANEL and by the BITUMINOUS MEMBRANE applied to the sheathing over the steel studs.
Precipitation	Control of precipitation is provided by the PRECAST PANELS, in combination with the two-stage joint between PANELS. The cavity in the joint between the WEATHER SEAL and AIR SEAL is drained to the exterior at the base of the joint. Most precipitation falling on the STUCCO clad wall is deflected by the STUCCO. The BITUMINOUS MEMBRANE behind the stucco forms a second line of protection for precipitation that may bypass the stucco. The stucco to precast junction is provided with a WEATHER SEAL composed of a backer rod and sealant.
Other Considerations	Interfacing between precast panels and stucco/steel stud assemblies requires attention to detail in order to ensure continuity of all performance requirements. It is especially critical because of the many different trades required for the stucco/steel stud construction.
Construction Sequence	<ul style="list-style-type: none">• Rigid insulation on column• Precast panels• Air seal and weather seal on precast• Insulation on back of precast• Steel stud back-up wall and sheathing behind stucco• Sheet metal air barrier support• Air barrier membrane over sheathing, across metal support to precast panel edge• Rigid insulation, metal lath and stucco• Weather seal between precast and stucco

Detail 10

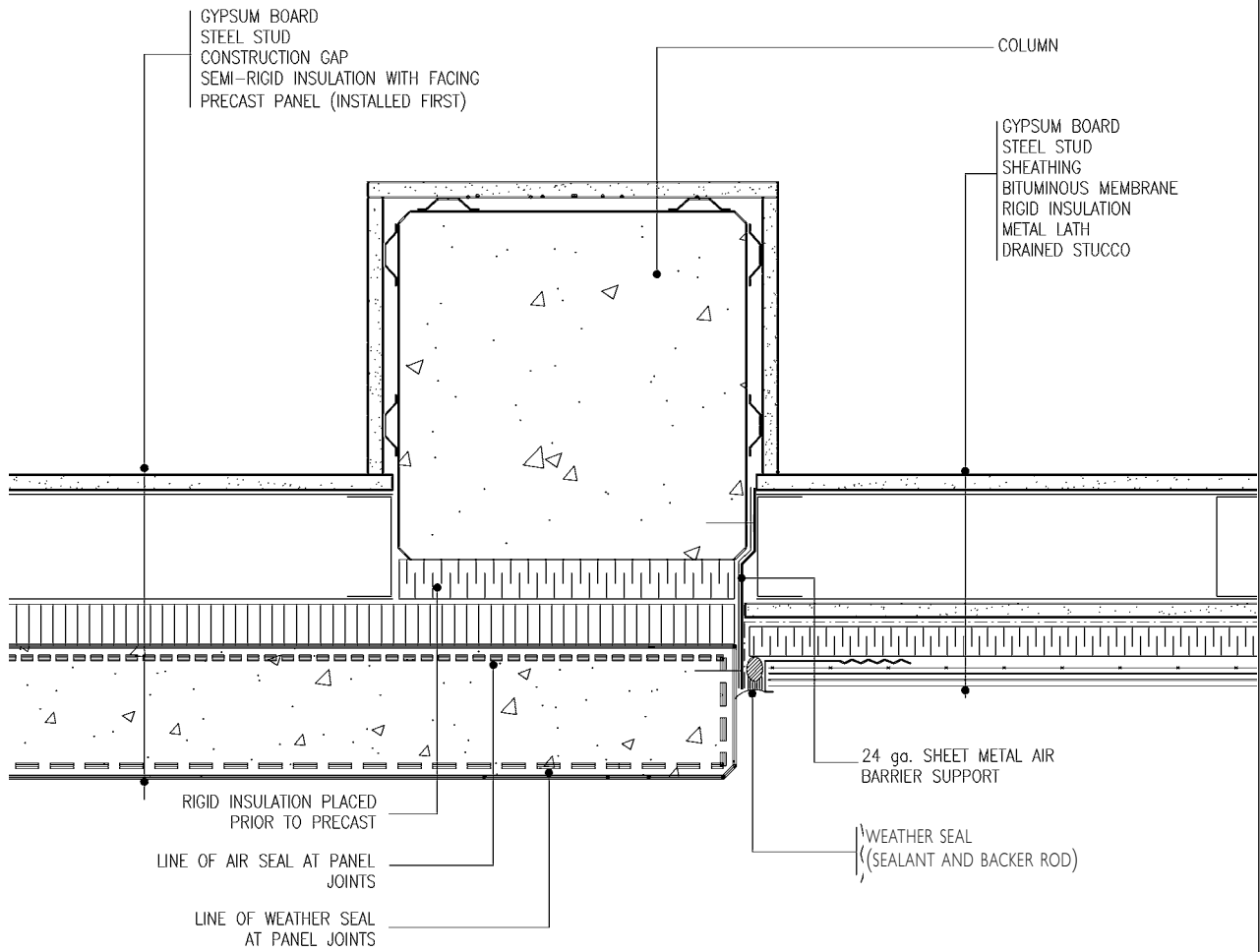

CONVENTIONAL PANEL
JUNCTION WITH STUCCO ON STEEL STUD WALL

BEST PRACTICE GUIDE
ARCHITECTURAL PRECAST CONCRETE WALLS

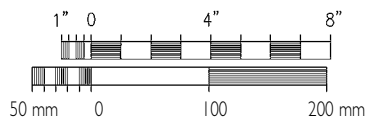

General	The insulated PRECAST PANEL system is installed with a two-stage joint. The BRICK VENEER/STEEL STUD wall is installed after precast erection.
Thermal Barrier	The thermal barrier is provided by the INSULATION that is field-installed on the PRECAST PANEL. The thermal barrier in the BRICK VENEER is provided by RIGID INSULATION on the outside of the BITUMINOUS MEMBRANE. The STEEL STUD WALL may be insulated depending on R-value requirements.
Air Barrier	The air barrier is provided by the PRECAST PANEL. Air barrier continuity between PANELS is provided by the AIR SEAL installed in line with the interior face of the PANELS. The air barrier within the BRICK VENEER/STEEL STUD wall is provided by the BITUMINOUS MEMBRANE adhered on the EXTERIOR SHEATHING, and continuity with the PRECAST PANEL is provided by adhering the MEMBRANE to the edge of the PRECAST PANEL. At the location where the air barrier membrane crosses the cavity, it is adhered to and supported by sheet metal.
Vapour Barrier	The vapour barrier is provided by the facing on the SEMI-RIGID INSULATION adhered to the back of the precast and by the BITUMINOUS MEMBRANE applied to the sheathing over the steel studs.
Precipitation	Control of precipitation is provided by the PRECAST PANELS, in combination with the two-stage joint between PANELS. The cavity in the joint between the WEATHER SEAL and AIR SEAL is drained to the exterior at the base of the joint. Most precipitation falling on the BRICK VENEER/STEEL STUD wall is deflected by the brick and the cavity behind the brick is drained. The brick to precast junction is provided with a WEATHER SEAL composed of a backer rod and sealant.
Other Considerations	Interfacing between precast panels and brick veneer/steel stud assemblies requires attention to detail in order to ensure continuity of all performance requirements. It is especially critical because of the many different trades required for the brick veneer/steel stud construction.
Construction Sequence	<ul style="list-style-type: none">• Rigid insulation on column• Precast panels• Air seal and weather seal at precast joints• Insulation on back of precast• Steel stud back-up wall and sheathing behind brick• Sheet metal air barrier support• Air barrier membrane over sheathing, across metal support to precast panel edge• Rigid insulation and brick• Weather seal between precast and brick

Detail 11

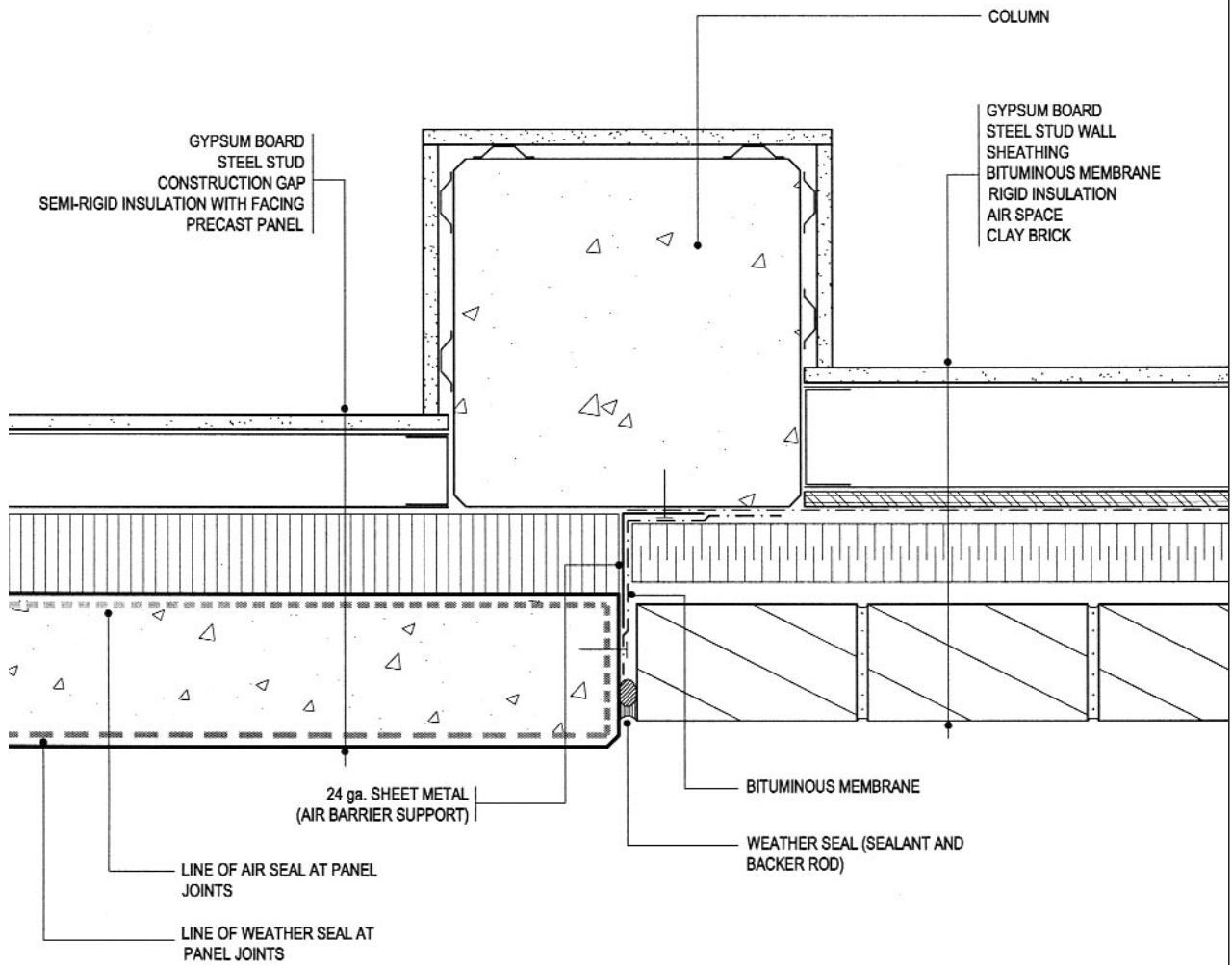

CONVENTIONAL PANEL
 JUNCTION WITH BRICK VENEER ON STEEL STUD WALL

BEST PRACTICE GUIDE
 ARCHITECTURAL PRECAST CONCRETE WALLS

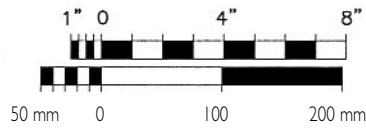

General

The PRECAST PANEL system is installed with a two-stage joint. The STEEL STUD back-up wall is installed after precast erection. The PRECAST COLUMN COVER, which is typically mounted to the CONCRETE COLUMN, continues the cladding assembly around the projecting column. Joints with adjacent panels are located to accommodate construction tolerances and thermal movement.

Thermal Barrier

The thermal barrier is provided by the SEMI-RIGID INSULATION installed on the back of the precast wall panels and by RIGID INSULATION on the exterior face of the CONCRETE COLUMN. The RIGID INSULATION must be in intimate contact with the CONCRETE COLUMN to avoid convective airflow that would render it ineffective.

Air Barrier

The air barrier is provided by the PRECAST with the AIR SEAL of the two-stage joint providing continuity between them. At the column, the air seal is transferred to the concrete via a sheet metal closure sealed to the column and back of panel.

Vapour Barrier

The vapour barrier is provided by the facing on the back of the SEMI-RIGID INSULATION and by the CONCRETE COLUMN.

Precipitation

Control of precipitation is provided by the PRECAST PANELS and PRECAST COLUMN COVER, in combination with the two-stage joint between PANELS. The cavity in the joint between the WEATHER SEAL and AIR SEAL is drained to the exterior at the base of the joint.

Other Considerations

Design and sequencing issues arise when finishing columns that project beyond the floor slab. The designer should consider the construction sequence in order to achieve continuity of the building science performance around the column.

Construction Sequence

- Rigid insulation to exterior column
- Precast panels
- Precast column cover
- Sheet metal air barrier closure between column and precast
- Angles to support windows to precast edge
- Semi-rigid insulation across precast edge to column and to back of precast
- Steel studs
- Bituminous membranes
- Air seal and weather seal on precast
- Urethane foam insulation between window and air seal

Detail 12

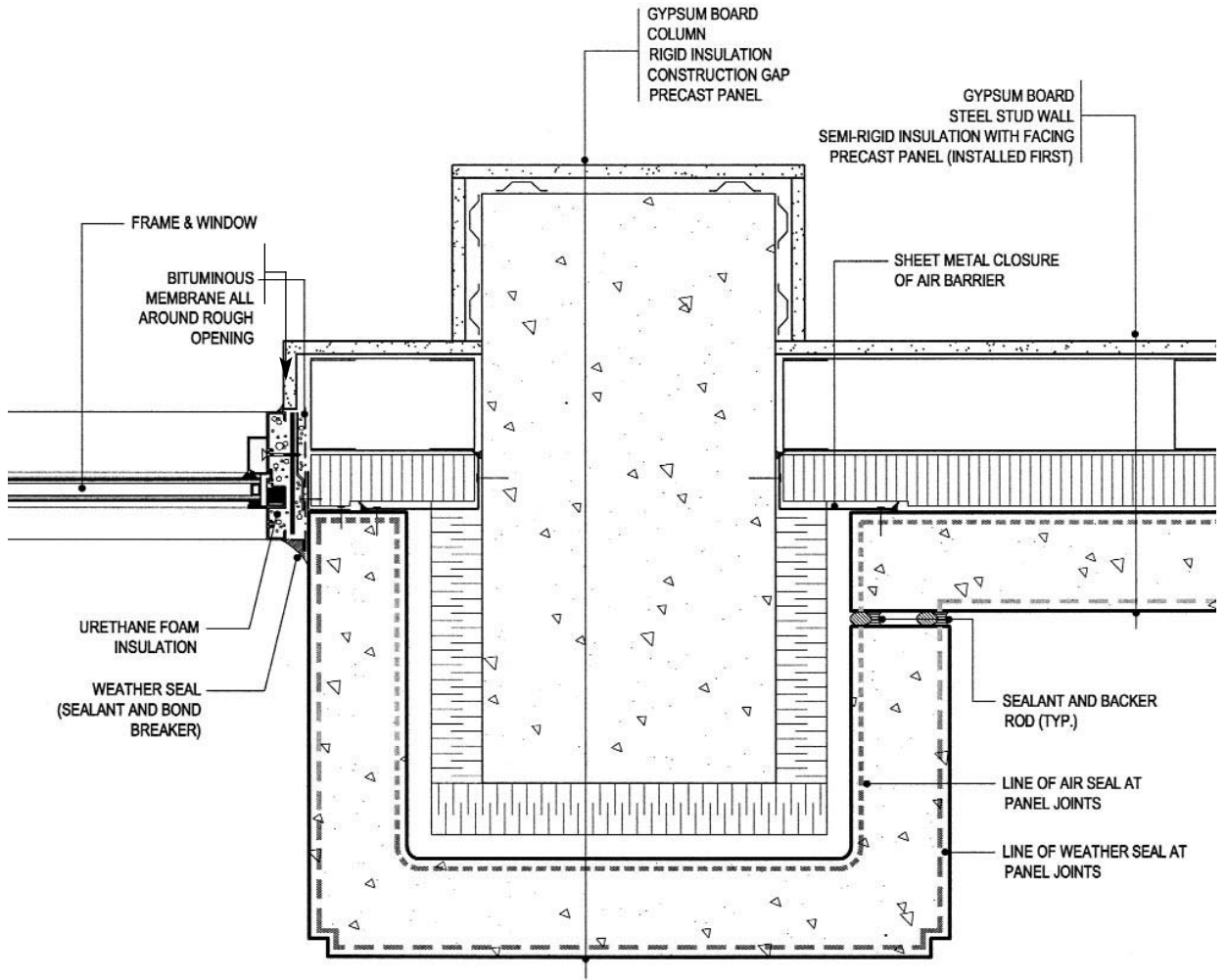

CONVENTIONAL PANEL
COLUMN COVER

BEST PRACTICE GUIDE
ARCHITECTURAL PRECAST CONCRETE WALLS

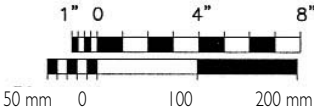

General

The PRECAST SANDWICH PANEL is bearing on the top of the CONCRETE FOUNDATION. A DOWEL is inserted into the FOUNDATION after PRECAST PANEL erection to provide a lateral connection. The SHIMS support and true the PANEL.

Thermal Barrier

The thermal barrier is provided by the RIGID INSULATION in the PRECAST SANDWICH PANEL. Note the RIGID INSULATION installed on the exterior of the CONCRETE FOUNDATION—this would not be necessary for buildings located in a warm to hot climate, or for buildings with low interior humidity regardless of the climate.

Air Barrier

The air barrier is provided by the STRUCTURAL WYTHER in the PRECAST SANDWICH PANEL. Air barrier continuity at the joints between panels is provided by the AIR SEAL and continuity at the CONCRETE FOUNDATION is provided by the connection of the AIR SEAL to the FOUNDATION.

Vapour Barrier

The vapour barrier is provided by the STRUCTURAL WYTHER with the AIR SEAL and by the CONCRETE FOUNDATION.

Precipitation

Control of precipitation is provided by the exterior wythe of the PRECAST SANDWICH PANEL in combination with the two-stage joint between panels. The joints drain to the exterior at the base via the AIR SEAL, which is tooled to provide a drainage path.

Other Considerations

Erection of the steel frame is followed by erection of PRECAST SANDWICH PANELS and installation of windows, doors and services. This system has additional benefit when the STRUCTURAL WYTHER can serve as the interior finish; under these circumstances, the joints may require a finish seal for aesthetic purposes.

Construction Sequence

- Precast panels, shim to suit
- Drilling and installation of steel dowel
- Air seal and weather seal
- Foundation insulation
- Interior finish seal between panels if required

Detail 13

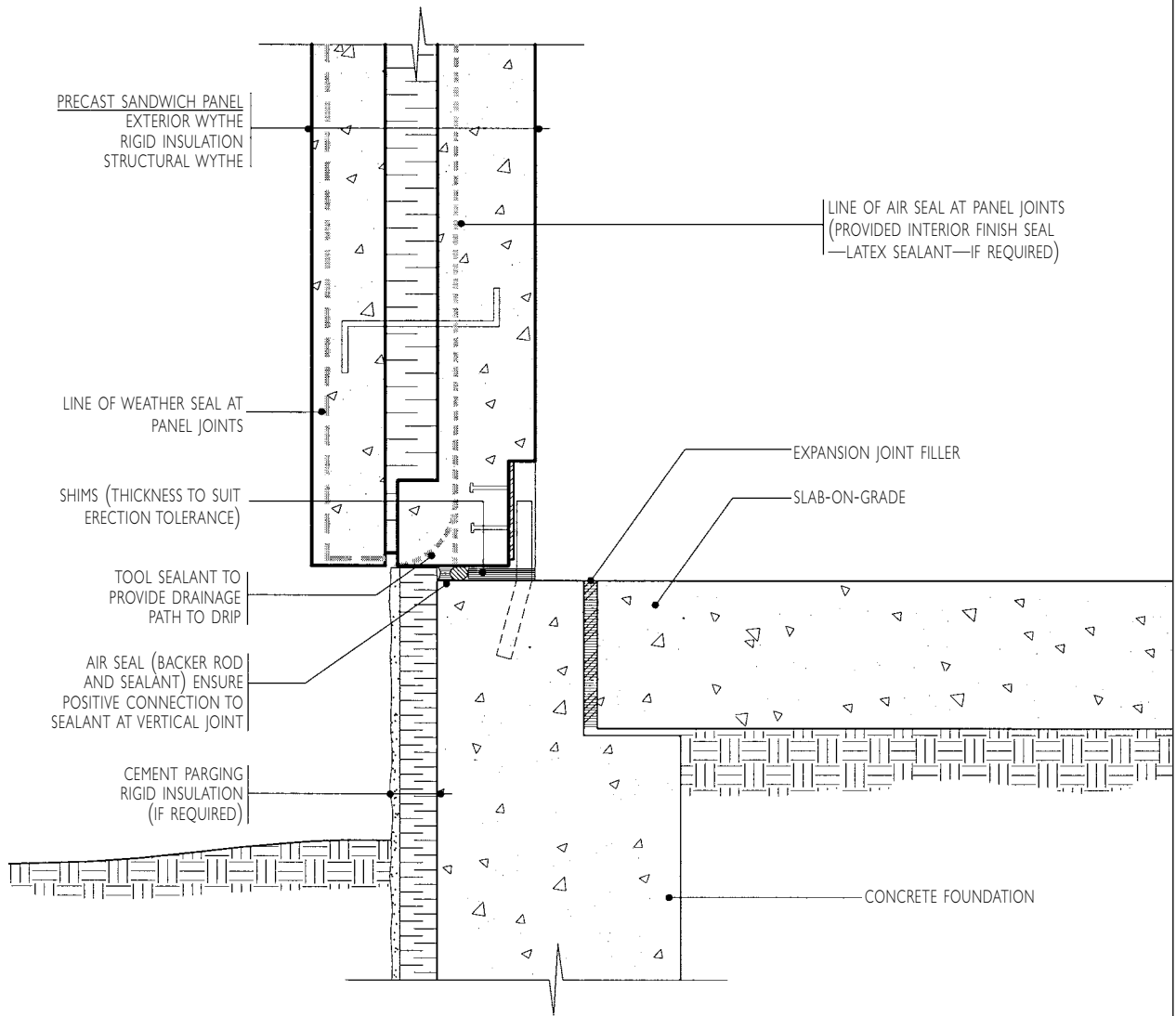

SANDWICH PANEL BOTTOM BEARING FOUNDATION CONNECTION

BEST PRACTICE GUIDE
ARCHITECTURAL PRECAST CONCRETE WALLS

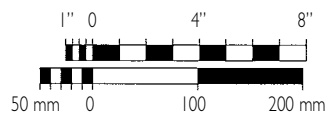

General

The soffit is designed as unconditioned space. The cladding above the soffit is PRECAST SANDWICH PANEL while the cladding below the soffit is CURTAIN WALL. An ANCHOR ANGLE is cast into the FLOOR SLAB to provide a lateral connection to the panel.

Thermal Barrier

The thermal barrier is provided by the RIGID INSULATION in the PRECAST SANDWICH PANEL, through the ADHERED SEMI-RIGID and RIGID INSULATION across the side and bottom of the FLOOR SLAB, to the head of the CURTAIN WALL. A thermal bridge exists in the STRUCTURAL WYTHER from the base of the panel to the top of the FLOOR SLAB, but it can be solved through suitable heating, ventilating and air conditioning (HVAC) design.

Air Barrier

The air barrier is provided by the STRUCTURAL WYTHER and continuity at the joints between panels is provided by the AIR SEAL. The SELF-LEVELLING AIR SEAL to the FLOOR SLAB, especially at the joints, while the BITUMINOUS MEMBRANE provides continuity from the FLOOR SLAB to the CURTAIN WALL.

Vapour Barrier

The vapour barrier is provided by the STRUCTURAL WYTHER with the AIR SEAL, the FLOOR SLAB and the CURTAIN WALL.

Precipitation

Control of precipitation is provided by the exterior wythe of the PRECAST SANDWICH PANELS, in combination with the two-stage joint between PANELS. The cavity in the joint between the WEATHER SEAL and AIR SEAL is drained to the exterior at the base of the joint. The outer wythe prevents rainwater runback at the base of the PANELS.

Other Considerations

It is important to decide whether the soffit is conditioned or unconditioned space since that decision will determine the location of the thermal, air and vapour barriers. A precast soffit is rarely used because erecting a precast soffit often requires unusual hoisting or jacking equipment. However, these problems can be avoided by combining a soffit with a spandrel panel in a single unit. Note that the soffit will likely be conditioned space if a precast spandrel unit is the design choice.

Construction Sequence

- Semi-rigid insulation to slab edge
- Precast panels
- Air seal and weather seal at precast joints
- Air seal connection to slab edge
- Steel studs and drywall
- Soffit details

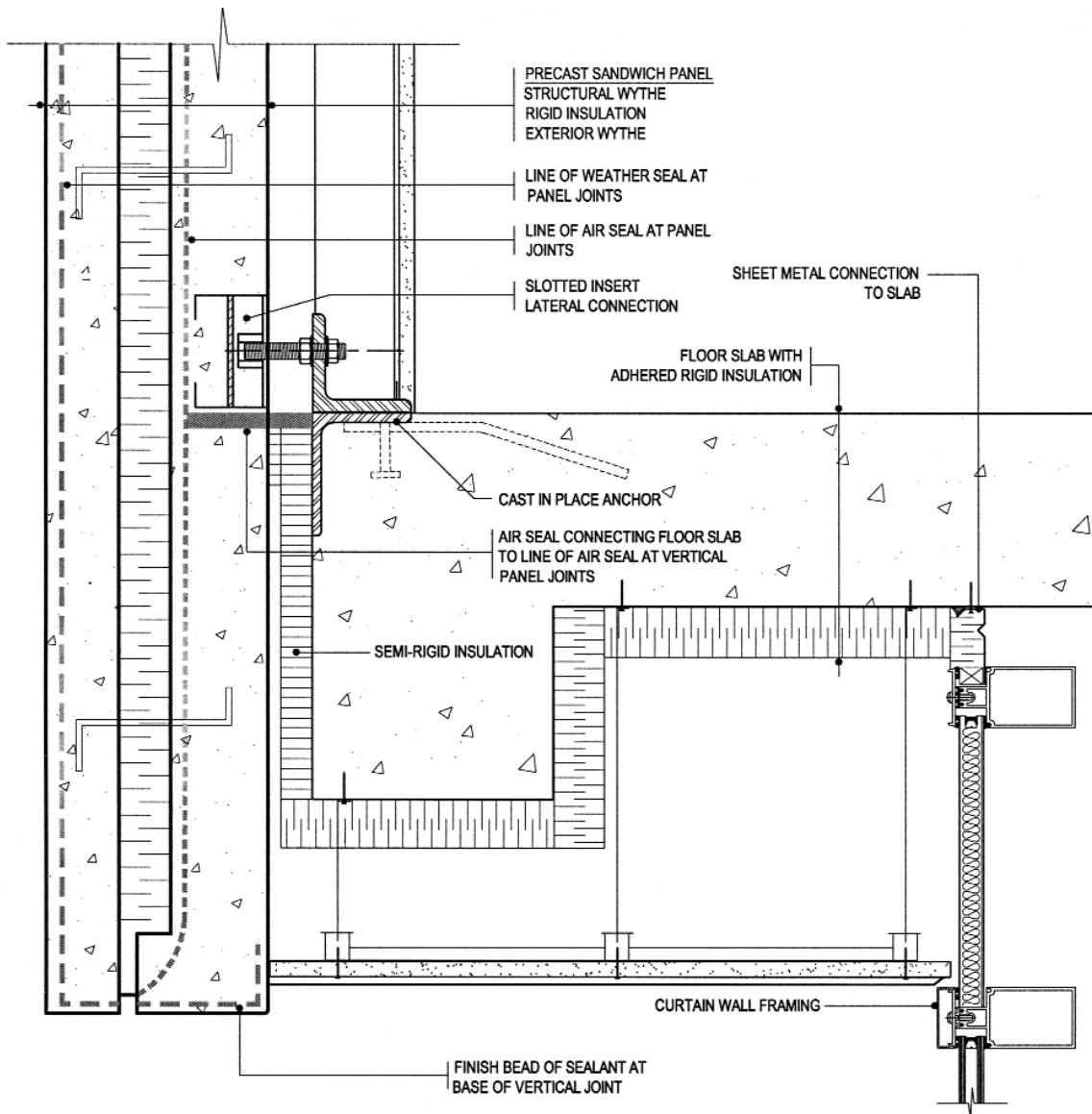

SANDWICH PANEL
SUSPENDED SOFFIT LATERAL CONNECTION

BEST PRACTICE GUIDE
ARCHITECTURAL PRECAST CONCRETE WALLS

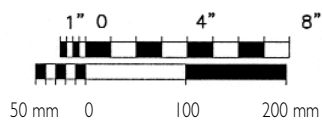

General

The PRECAST SANDWICH PANEL is bearing on the ANCHOR ANGLE cast in the FLOOR SLAB, with the LATERAL SLOTTED ANCHOR PLATE providing the connection between panels. This is the simplest connection because it is panel-to-panel and the precast fabricator is responsible for all elements.

Thermal Barrier

The thermal barrier is provided by the RIGID INSULATION in the PRECAST SANDWICH PANEL.

Air Barrier

The air barrier is provided by the STRUCTURAL WYTHER and continuity at the joints between panels is provided by the AIR SEAL. The SMOKE STOP provides continuity from the AIR SEAL to the FLOOR SLAB, especially at the joints.

Vapour Barrier

The vapour barrier is provided by the STRUCTURAL WYTHER.

Precipitation

Control of precipitation is provided by the rainscreen design of the PRECAST SANDWICH PANEL (DRAINAGE SPACE) and the two-stage joint between panels. Water that enters past the rainscreen (EXTERIOR WYTHER and WEATHER SEAL) drains to the horizontal joint, where it is taken laterally to the vertical joints and drained to the exterior through weep holes. Holding the drainage to the vertical joints eliminates the potential for drained water to randomly run over the face of the panels, and especially windows. Note the slope on the horizontal joint, which directs water away from the AIR SEAL.

Other Considerations

The structural connection is typical of a façade consisting of precast panels with punched windows. A façade consisting of spandrel panels and strip windows would have a different structural connection, and would require additional coordination with a glazing contractor.

Construction Sequence

- Semi-rigid mineral fibre to slab edge
- Precast panels
- Air seal and weather seal
- Air seal connection to panel edge

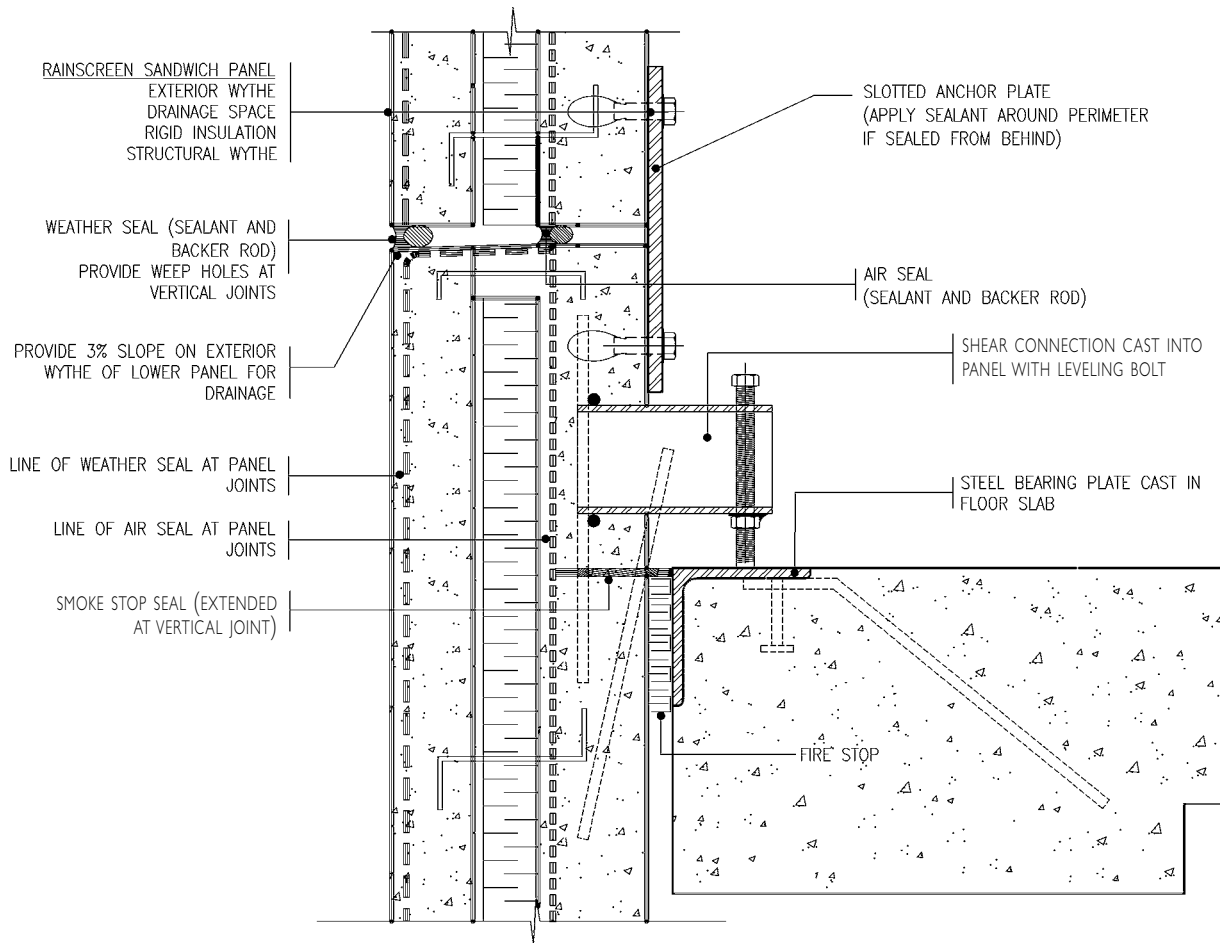

SANDWICH PANEL WITH RAINSCREEN
BEARING CONNECTION TO SLAB EDGE

BEST PRACTICE GUIDE
ARCHITECTURAL PRECAST CONCRETE WALLS

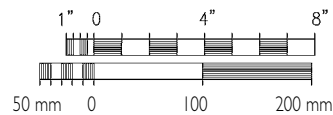

General

This detail presents a design for a precast wall system on a steel-frame building. The PRECAST SANDWICH PANEL system is bearing on the foundation. The critical feature is the deflection under live load of the steel frame relative to the PRECAST SANDWICH PANEL, and the stress this applies to the roof/wall air barrier connection and the roofing felts at the junction with the roof and wall.

Thermal Barrier

The thermal barrier is provided by the RIGID INSULATION in the PRECAST SANDWICH PANEL. Continuity with the RIGID INSULATION on the ROOF is maintained at the parapet by PRESSURE-TREATED (P/T) BLOCKING and MEDIUM-DENSITY MINERAL WOOL INSULATION across the top of the parapet, and between the WOOD CURB and the STRUCTURAL WYTHER. In addition, BATT INSULATION fills in the WOOD CURB.

Air Barrier

The air barrier is provided by the STRUCTURAL WYTHER and continuity at the joints between panels is provided by the AIR SEAL. At the parapet, the AIR SEAL is carried over to meet a flexible ELASTOMERIC AIR BARRIER that is fastened to the interior face of the STRUCTURAL WYTHER with a continuous bar. The ELASTOMERIC AIR BARRIER in turn connects to the BUILT-UP ROOF (B.U.R.)

Vapour Barrier

The vapour barrier is provided by the STRUCTURAL WYTHER. The STRUCTURAL WYTHER is connected to the roof VAPOUR BARRIER via the ELASTOMERIC AIR BARRIER, which also acts as the vapour barrier in this design.

Precipitation

Control of precipitation is provided by the PRECAST SANDWICH PANEL, in combination with the two-stage joint between panels. The sloped flashing assembly over the parapet protects the top of the PANELS from precipitation.

Other Considerations

This design of the roof/wall junction allows for deflection of the roof perimeter beam due to snow or other live loads. This is of particular concern in areas of high design snow load or locations where snow can accumulate because of higher adjacent structures. The roof membranes and flashing are similar to details in the *Canadian Roofing Contractor's Association Manual*.

Construction Sequence

- Precast panels
- Elastomeric air barrier membrane to back of precast above roof
- Air seal and weather seal at precast joints
- Parapet construction
- Roofing
- Interior finish seals between panels if required

Detail 16

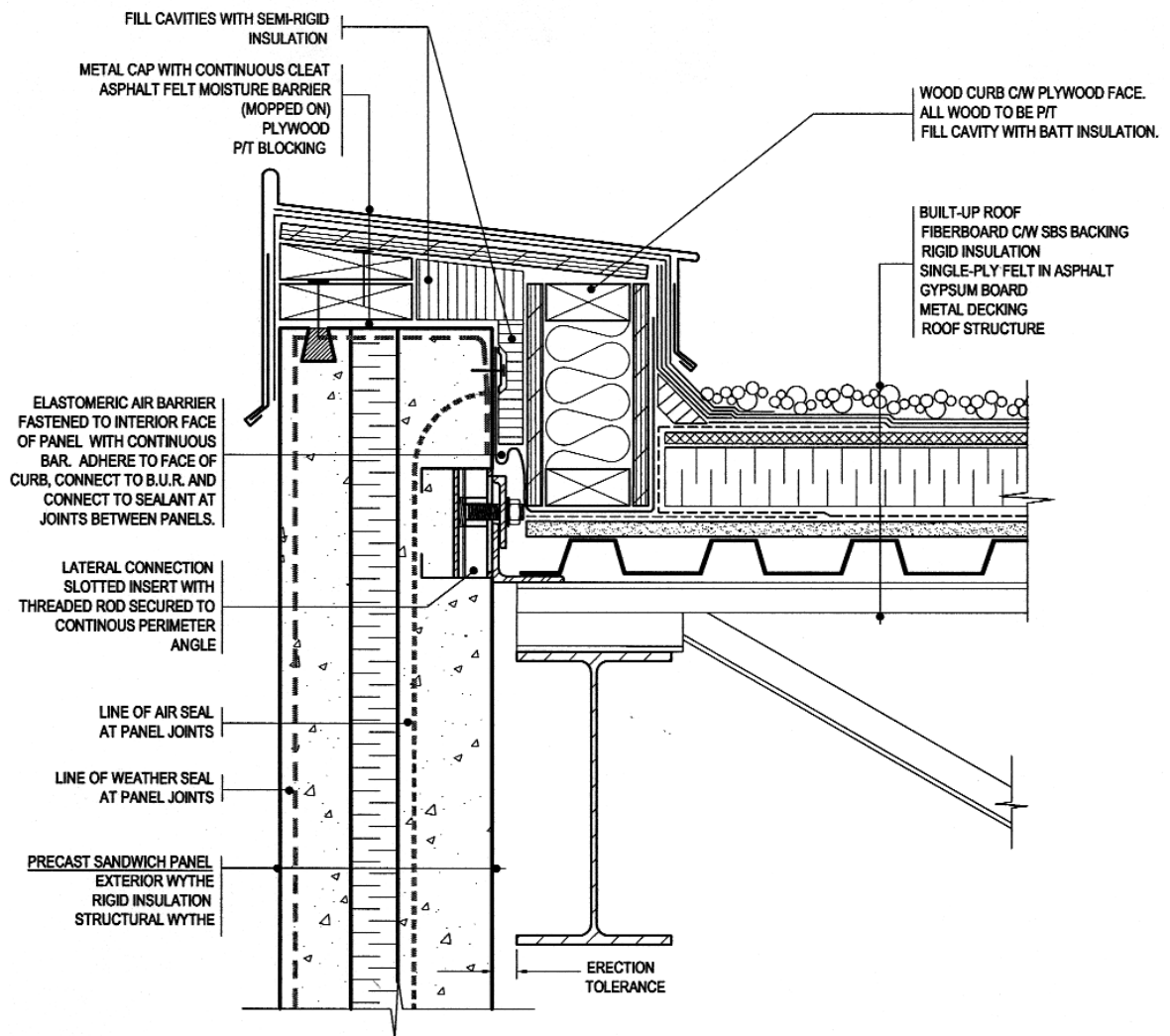

SANDWICH PANEL
ROOF/WALL PARAPET

BEST PRACTICE GUIDE
ARCHITECTURAL PRECAST CONCRETE WALLS

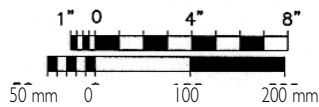

General	In this alternate roof/wall junction for a precast wall system on a steel-frame building, the design assumes limited movement between the roof perimeter beam and the wall. The PRECAST SANDWICH PANEL system is bearing on the foundation.
Thermal Barrier	The thermal barrier is provided by the RIGID INSULATION in the PRECAST SANDWICH PANEL. Continuity with the RIGID INSULATION on the ROOF is maintained at the parapet by P/T BLOCKING and MEDIUM-DENSITY MINERAL WOOL on the roof-side face of the PANEL.
Air Barrier	The air barrier is provided by the STRUCTURAL WYTHER and continuity at the joints between panels is provided by the AIR SEAL. At the parapet, the AIR SEAL is carried over to meet a flexible ELASTOMERIC AIR BARRIER that is fastened to the interior face of the STRUCTURAL WYTHER with a continuous bar. The ELASTOMERIC AIR BARRIER in turn connects to the BUILT-UP ROOF.
Vapour Barrier	The vapour barrier is provided by the STRUCTURAL WYTHER. The STRUCTURAL WYTHER is connected to the roof VAPOUR BARRIER via the ELASTOMERIC AIR BARRIER, which also acts as the vapour barrier in this design.
Precipitation	Control of precipitation is provided by the PRECAST SANDWICH PANEL, in combination with the two-stage joint between panels. The sloped flashing assembly over the parapet protects the top of the PANELS from precipitation.
Other Considerations	This design of the roof/wall junction assumes limited deflection of the roof perimeter beam relative to the panels. This is acceptable in areas where design snow loads are low. The roof membranes and flashing are similar to details in the <i>Canadian Roofing Contractor's Association Manual</i> .
Construction Sequence	<ul style="list-style-type: none">• Precast panels• Elastomeric air barrier membrane to back of precast above roof• Air seal and weather seal• Parapet construction• Roofing• Interior finish seals between panels if required

Detail 17

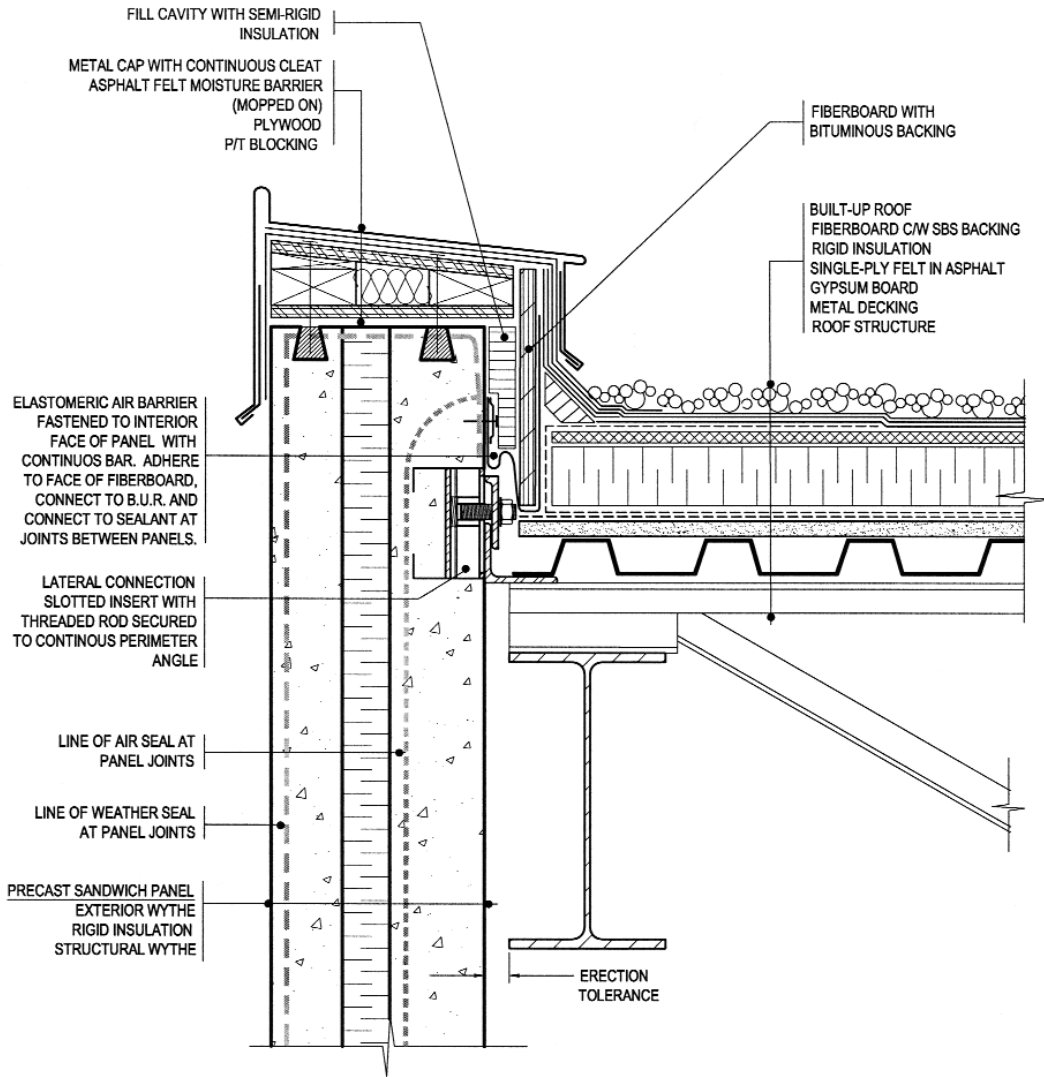

SANDWICH PANEL
ROOF/WALL PARAPET

BEST PRACTICE GUIDE
ARCHITECTURAL PRECAST CONCRETE WALLS

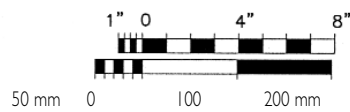

General

The insulated PRECAST SANDWICH PANEL system is designed as a rainscreen system. This detail illustrates a DOOR installed in a punched opening.

Thermal Barrier

The thermal barrier is provided by the RIGID INSULATION in the PRECAST SANDWICH PANEL. Continuity at DOOR perimeters is provided by the urethane foam.

Air Barrier

The air barrier is provided by the STRUCTURAL WYTHER in the PRECAST PANEL. Air barrier continuity at the joints between panels is provided by the AIR SEAL and at the DOOR JUNCTIONS it is provided by the AIR SEAL located between the STRUCTURAL WYTHER and the DOOR FRAME. The air barrier design for the DOOR is provided by the manufacturer.

Vapour Barrier

The vapour barrier is provided by the STRUCTURAL WYTHER in the PRECAST PANEL.

Precipitation

Control of precipitation is achieved by the rainscreen design of the PRECAST SANDWICH PANEL (DRAINAGE SPACE), in combination with the two-stage joint between panels. Water that enters the cavity is directed to drain at the vertical joints. The door manufacturer provides the precipitation control design for the DOOR, and the building designer must specify a level of performance that is appropriate to the building requirements.

Construction Sequence

- Precast panels
- Window head flashing
- Air seal and weather seal at door to precast panel
- Air seal and weather seal at precast joints

Detail 18

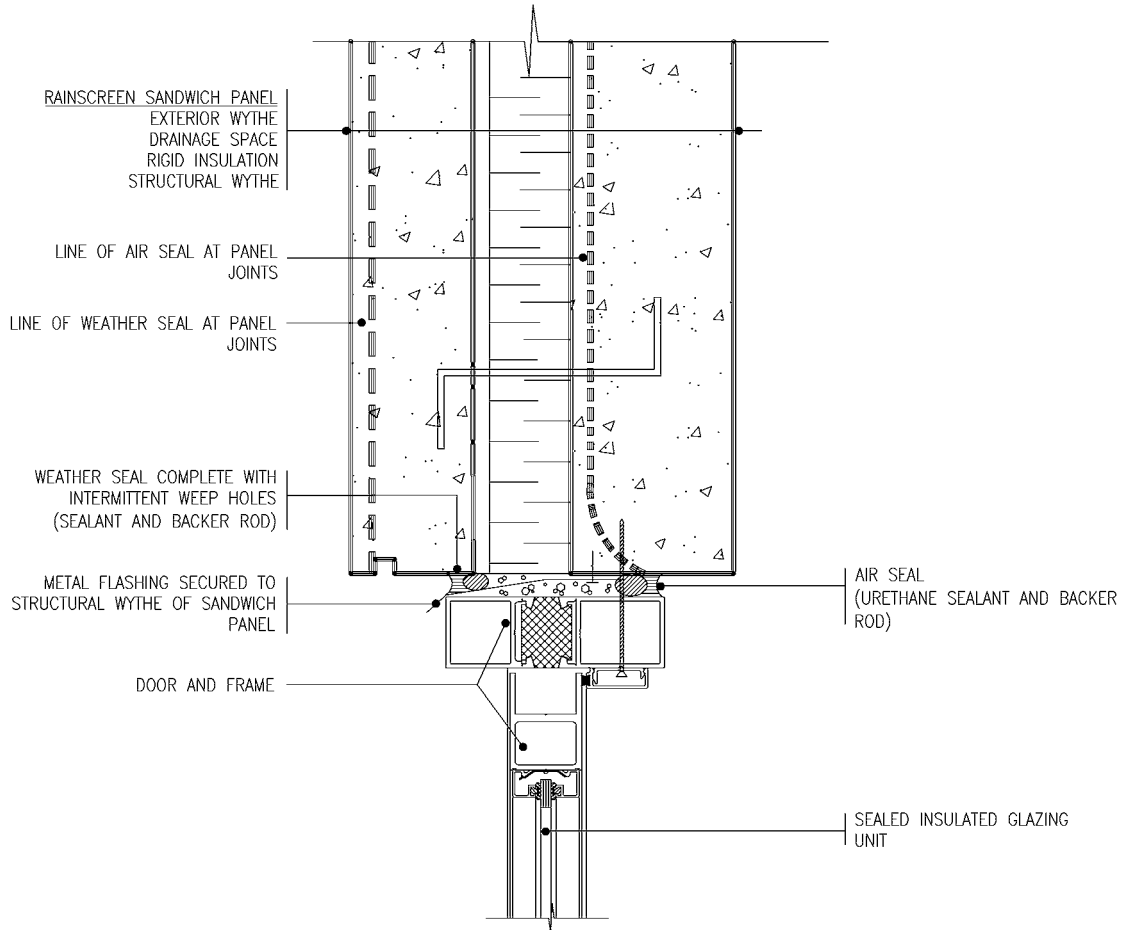

SANDWICH PANEL WITH RAINSCREEN DOOR HEAD TO RAINSCREEN PANEL

BEST PRACTICE GUIDE
ARCHITECTURAL PRECAST CONCRETE WALLS

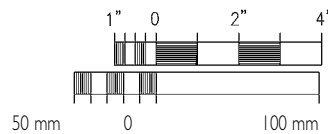

General

The insulated PRECAST SANDWICH PANEL system is designed as a rainscreen system. The installation illustrates a DOOR at a panel edge.

Thermal Barrier

The thermal barrier is provided by the RIGID INSULATION in the PRECAST SANDWICH PANEL. Continuity at DOOR perimeters is provided by the urethane foam.

Air Barrier

The air barrier is provided by the STRUCTURAL WYTHER in the PRECAST PANEL. Air barrier continuity at the joints between panels is provided by the AIR SEAL, and at the DOOR JUNCTION it is provided by the AIR SEAL located between the STRUCTURAL WYTHER and the DOOR FRAME. The air barrier design for the DOOR is provided by the manufacturer.

Vapour Barrier

The vapour barrier is provided by the STRUCTURAL WYTHER in the PRECAST PANEL.

Precipitation

Control of precipitation is achieved by the rainscreen design of the PRECAST SANDWICH PANEL (DRAINAGE SPACE), in combination with the two-stage joint between panels. Water that enters the cavity is eventually directed to drain at the vertical joints. The door manufacturer provides the precipitation control design for the DOOR, and the building designer must specify a level of performance that is appropriate to the building requirements.

Construction Sequence

- Precast panel
- Air seal and weather seal at door to precast panel
- Air seal and weather seal at precast joints

INSIDE

OUTSIDE

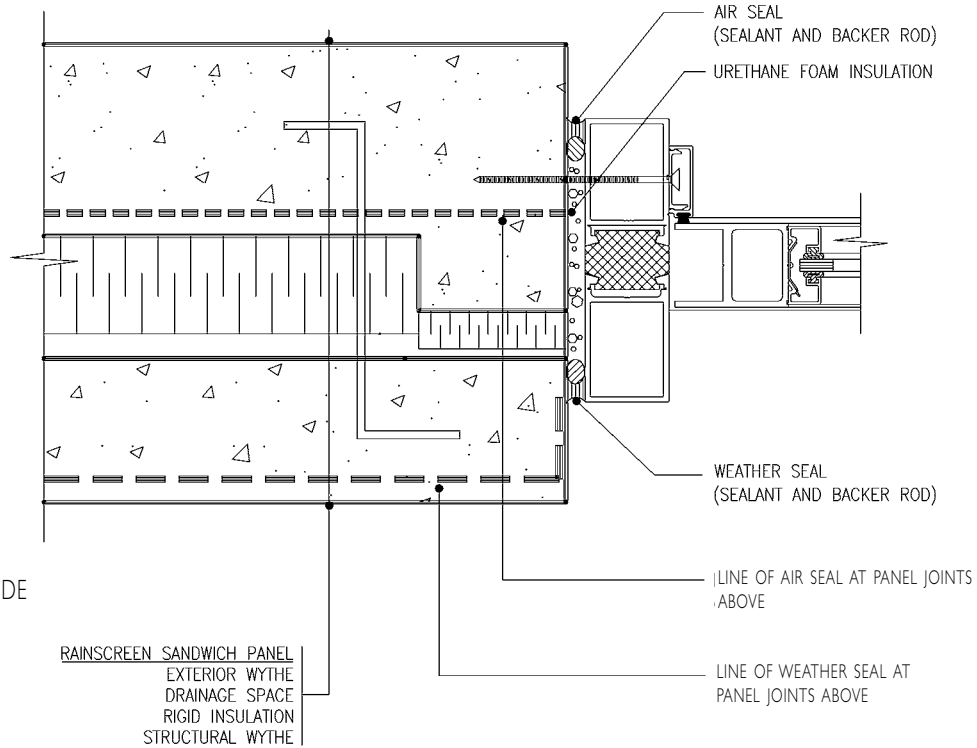

SANDWICH PANEL WITH RAINSCREEN
DOOR JAMB TO RAINSCREEN PANEL

BEST PRACTICE GUIDE
ARCHITECTURAL PRECAST CONCRETE WALLS

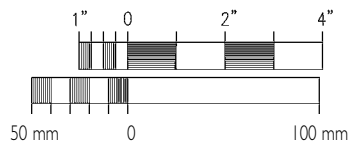

General

This detail presents a head and sill connection for a punched WINDOW.

Thermal Barrier

The thermal barrier is provided by the RIGID INSULATION in the PRECAST SANDWICH PANEL. Continuity across the junction with the WINDOW is provided with LOW-EXPANSION POLYURETHANE FOAM.

Air Barrier

The air barrier is provided by the STRUCTURAL WYTHER in the PRECAST PANEL. Air barrier continuity at the joints between panels is provided by the AIR SEAL and at the WINDOW JUNCTION it is provided by LOW-EXPANSION POLYURETHANE FOAM located between the STRUCTURAL WYTHER and the WINDOW FRAME. The air barrier design for the WINDOW is provided by the window manufacturer.

Vapour Barrier

The vapour barrier is provided by the STRUCTURAL WYTHER in the PRECAST PANEL, and by the glazing and frame in the WINDOW.

Precipitation

Control of precipitation is achieved by the rainscreen design of the PRECAST SANDWICH PANEL (DRAINAGE SPACE), in combination with the two-stage joint between panels. Water that enters the cavity is eventually directed to drain at the vertical joints. A flashing at the window head diverts water in the cavity to the exterior. The window manufacturer provides the precipitation control design for the WINDOW, and the building designer must specify a level of performance that is appropriate to the building requirements.

Other Considerations

Punched windows are installed within precast panels, while strip windows are installed on the building as rows (or strips) located between rows of precast spandrel panels. With strip windows, the design must ensure that frame shortening doesn't transfer structural load to the windows, and that vertical joints in the panels that intersect the window head/sill are properly addressed with flashing and sealants.

Construction Sequence

- Precast panels
- Air seal and weather seal at precast joints
- Window head flashing
- Window head retention clips
- Window installation
- Polyurethane foam insulation between window and air seal
- Weather seal at window surround
- Interior furring and drywall

Detail 20

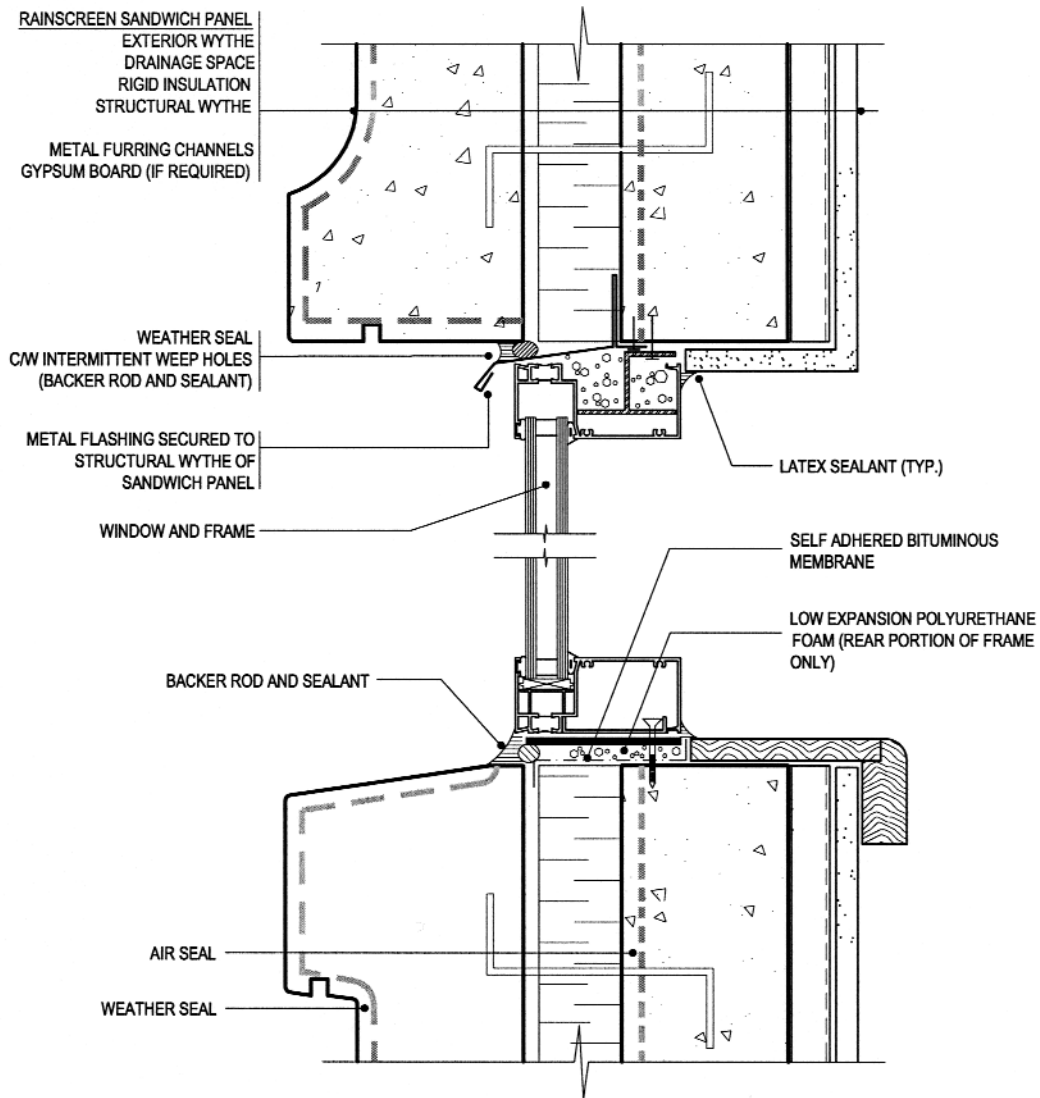

SANDWICH PANEL WITH RAINSCREEN
WINDOW HEAD/SILL TO RAINSCREEN PANEL

BEST PRACTICE GUIDE
ARCHITECTURAL PRECAST CONCRETE WALLS

E

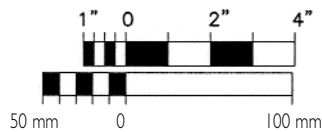

General	This detail presents a connection between a curtain wall jamb and adjacent precast.
Thermal Barrier	The thermal barrier is provided by the RIGID INSULATION in the PRECAST SANDWICH PANEL. The thermal break and insulated glass units in the CURTAIN WALL are installed in line with the RIGID INSULATION in the PRECAST PANEL.
Air Barrier	The air barrier is provided by the STRUCTURAL WYTHE, and continuity at the joints between panels is provided by the AIR SEAL. Continuity to the CURTAIN WALL is provided by the ELASTOMERIC MEMBRANE that is adhered and clamped to the edge of the STRUCTURAL WYTHE and clamped to the CURTAIN WALL with SOLID BLOCKING below the pressure plate.
Vapour Barrier	The vapour barrier is provided by the STRUCTURAL WYTHE. The STRUCTURAL WYTHE is connected to the CURTAIN WALL via the SELF-ADHERED BITUMINOUS MEMBRANE, which also acts as the vapour barrier in this design.
Precipitation	Control of precipitation is achieved by the PRECAST SANDWICH PANEL, in combination with the two-stage joint between panels. The curtain wall manufacturer designs the precipitation control for the CURTAIN WALL, and the building designer must specify a level of performance that is appropriate to the building requirements. The glazing deflects most precipitation at the CURTAIN WALL and glazing rabbets drain to the exterior. A WEATHER SEAL is provided at the junction between the PRECAST PANEL and CURTAIN WALL by backer rod and sealant.
Other Considerations	The PRECAST SANDWICH PANEL and CURTAIN WALL have a potential advantage in that each system is fabricated by a single manufacturer. However, the junction will not be designed unless someone, for example, the building designer, takes responsibility for the design.
Construction Sequence	<ul style="list-style-type: none">• Precast panels• Air seal and weather seal at precast joints• Elastomeric air barrier clamped with continuous clip to structural wythe of precast• Curtain wall installation• Air barrier tie-in at shoulder of curtain wall• Weather seal between curtain wall and precast• Polyurethane foam between curtain wall and precast• Interior finish seal

Detail 21

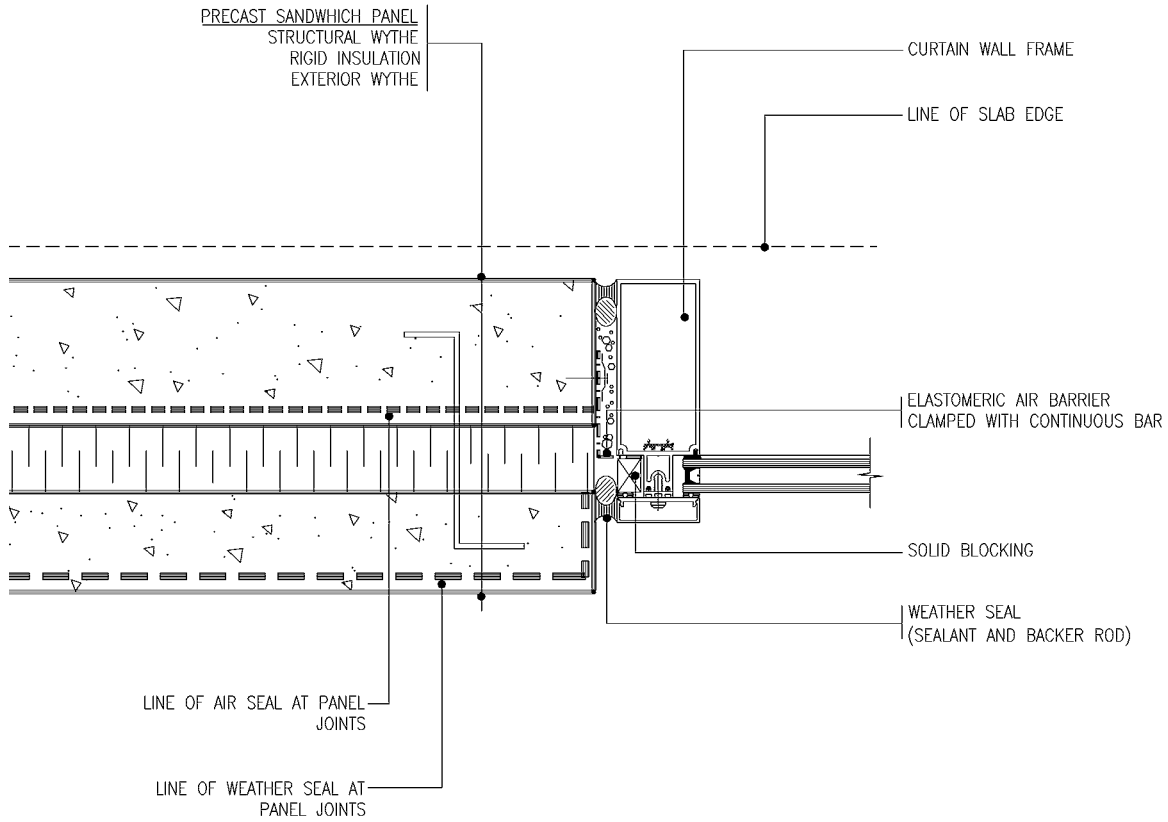

SANDWICH PANEL
JUNCTION WITH CURTAIN WALL (JAMB)

BEST PRACTICE GUIDE
ARCHITECTURAL PRECAST CONCRETE WALLS

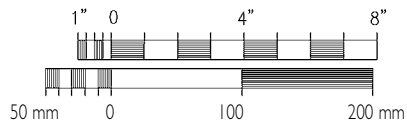

General

The insulated PRECAST SANDWICH PANEL system is cast or cored to accept the duct or pipe penetration with the tolerance required to accept flashing and gaskets.

Thermal Barrier

The thermal barrier is provided by the RIGID INSULATION in the PRECAST SANDWICH PANEL. Continuity of the thermal barrier around the penetration is maintained through the application of URETHANE FOAM.

Air Barrier

The air barrier is provided by the STRUCTURAL WYTHER, and continuity at the joints between panels is provided by the AIR SEAL. Continuity to the SERVICE PENETRATION is provided by the AIR SEAL (URETHANE FOAM) that is sprayed between the SERVICE PENETRATION and the opening in the STRUCTURAL WYTHER.

Vapour Barrier

The vapour barrier is provided by the STRUCTURAL WYTHER. The STRUCTURAL WYTHER is connected to the SERVICE PENETRATION via the URETHANE FOAM, which also acts as the vapour barrier in this design.

Precipitation

Control of precipitation is achieved by the PRECAST SANDWICH PANEL, in combination with the two-stage joint between panels. The manufacturer designs the precipitation control for the SERVICE PENETRATION, and the building designer must specify a level of performance that is appropriate to the building requirements. A WEATHER SEAL is provided at the junction between the PRECAST PANEL and SERVICE PENETRATION. Control of precipitation is further enhanced by flashing or louvers which deflect precipitation to the wall below.

Other Considerations

The location and design of service penetration through precast panels must be coordinated with the mechanical engineer.

Construction Sequence

- Precast panels
- Duct and exterior collars
- Exterior weather seal at penetration
- Urethane foam insulation air seal

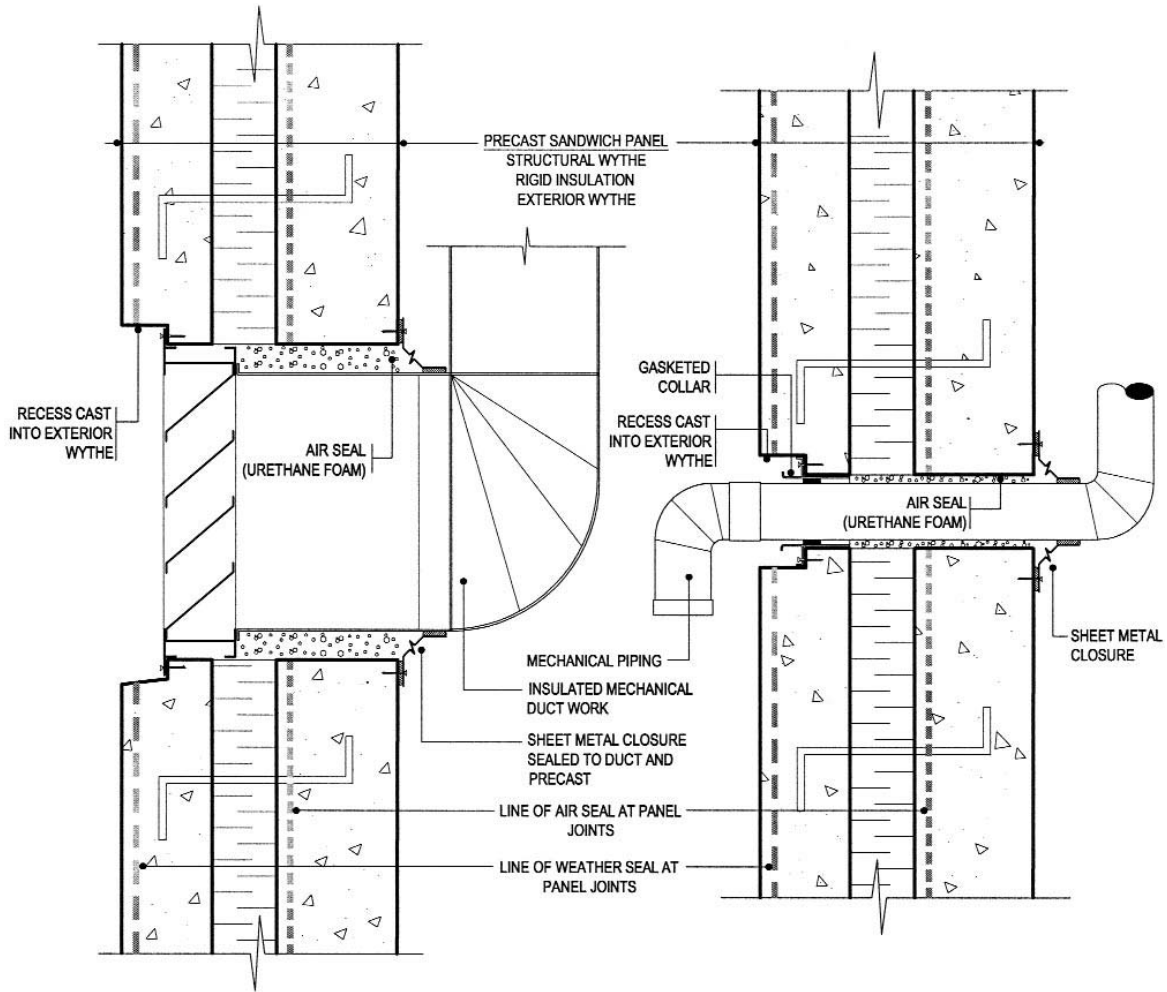

SANDWICH PANEL WITHOUT DRAINAGE SERVICE PENETRATIONS

BEST PRACTICE GUIDE
ARCHITECTURAL PRECAST CONCRETE WALLS

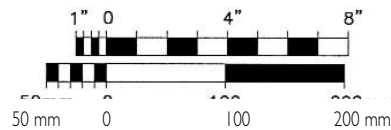

- General** The insulated PRECAST SANDWICH PANEL and BRICK VENEER/STEEL STUD systems are both designed as rainscreen assemblies. The BRICK VENEER/STEEL STUD backup wall is installed after erection of the PRECAST PANEL.
- Thermal Barrier** The thermal barrier is provided by the RIGID INSULATION in the PRECAST SANDWICH PANEL. The thermal barrier in the BRICK VENEER/STEEL STUD wall is provided by the RIGID INSULATION, which is placed approximately in line with the RIGID INSULATION in the PRECAST PANEL.
- Air Barrier** The air barrier is provided by the STRUCTURAL WYTHER and continuity at the joints between panels is provided by the AIR SEAL. Continuity to the BRICK VENEER/STEEL STUD wall is provided by the BITUMINOUS MEMBRANE backed-up by a sheet metal cavity baffle, which is secured to the edge of the STRUCTURAL WYTHER, and adhered and fastened to the COLUMN and GYPSUM SHEATHING.
- Vapour Barrier** The vapour barrier is provided by the STRUCTURAL WYTHER. The STRUCTURAL WYTHER is connected to the BRICK VENEER/STEEL STUD wall via the BITUMINOUS MEMBRANE, which also acts as the vapour barrier in this design.
- Precipitation** Control of precipitation is achieved by the rainscreen design of the PRECAST SANDWICH PANEL (DRAINAGE SPACE), in combination with the two-stage joint between panels. The BRICK VENEER/STEEL STUD wall has a traditional rainscreen design to control precipitation. The CLAY BRICK VENEER deflects most precipitation and the AIR SPACE drains to the exterior. A WEATHER SEAL of backer rod and sealant is installed at the junction between the PRECAST PANEL and CLAY BRICK VENEER.
- Other Considerations** The BRICK VENEER/STEEL STUD wall is installed by a number of trades and coordination with the precast installer is essential. In addition, as with the curtain wall, the junction with the PRECAST SANDWICH PANEL will not be designed unless someone, for example, the building designer, takes responsibility for it.
- Construction Sequence**
- Precast panels
 - Air seal and weather seal on precast, sheet metal cavity baffle and membrane support
 - Steel stud back-up for brick veneer, exterior sheathing, bituminous membrane, insulation
 - Brick veneer
 - Weather seal between precast and brick veneer
 - Steel studs and drywall on interior of precast as required
 - Drywall to steel stud back-up for brick veneer

Detail 23

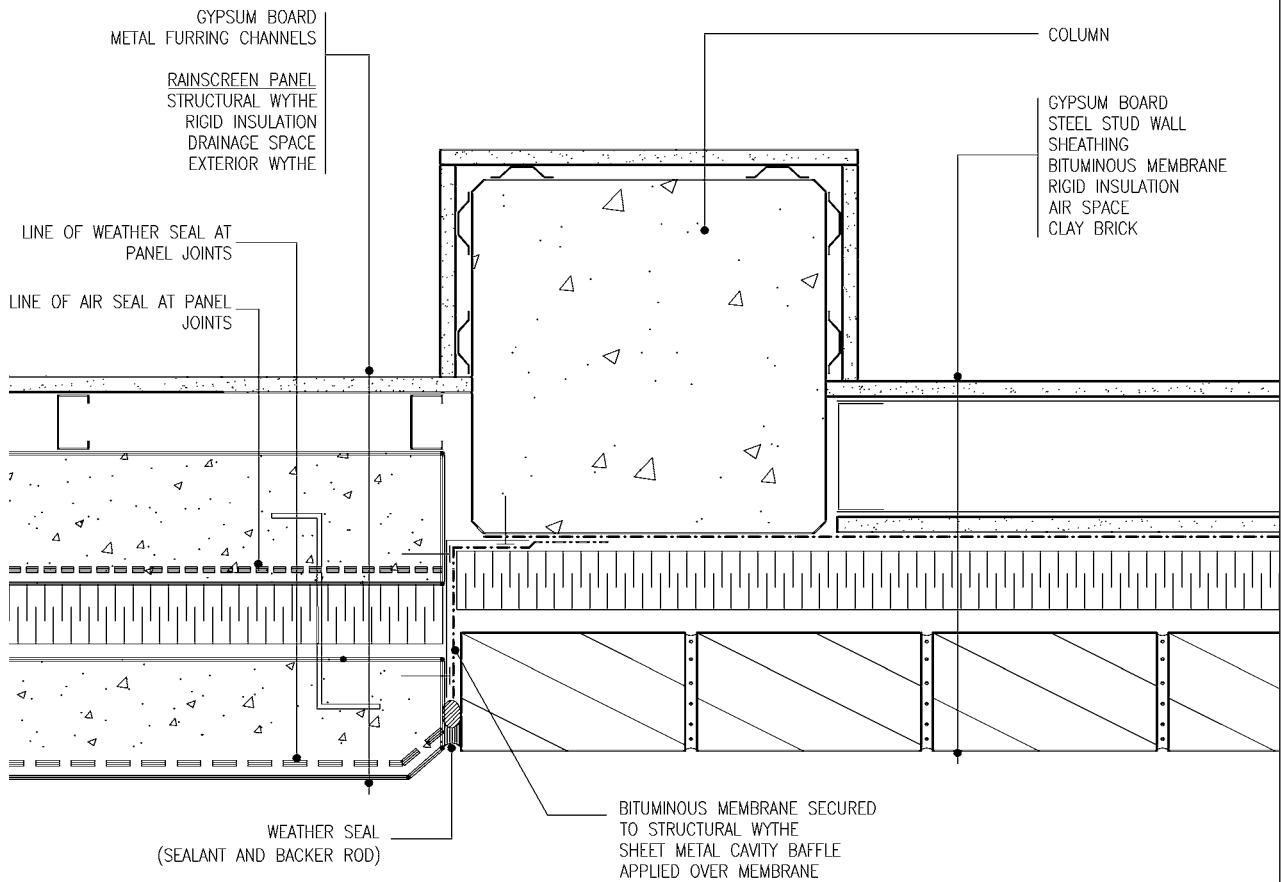

SANDWICH PANEL WITH RAINSCREEN JUNCTION WITH BRICK VENEER ON STEEL STUD WALL

BEST PRACTICE GUIDE
ARCHITECTURAL PRECAST CONCRETE WALLS

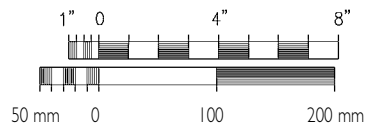

5

CHAPTER FIVE

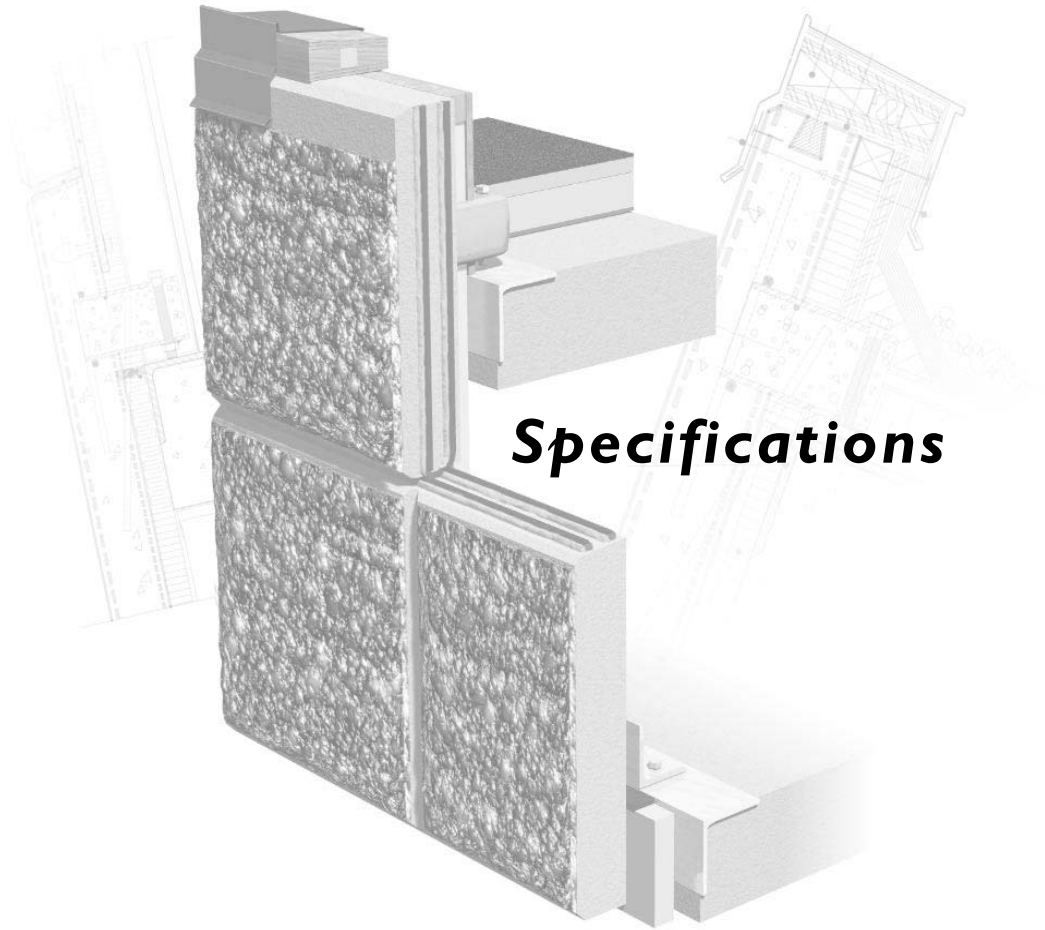

Specifications

GENERAL

The following sample specification section for Architectural Precast Concrete Wall panels is intended to be read in conjunction with the details illustrated in this Chapter. Neither the details nor the specification purports to illustrate the only materials available in the construction of architectural precast. Specifiers and designers should obtain information regarding local availability of materials and finishes, manufacturing methods and limitations, and historical evidence of good performance for specified materials.

SAMPLE SPECIFICATION

This section was developed from the *National Master Specification Section, 03450 Plant-Precast Architectural Concrete* developed by the National Master Specification Secretariat of Public Works and Government Services Canada (Architectural and Engineering Services). It is provided as a sample specification only, and must be edited to suit project specific requirements. The reader is also referred to A23.4-00/A251-00 Precast Concrete – Materials and Construction / Qualification Code for Architectural and Structural Precast Concrete Products.

The reader should refer to the most current version of the *National Master Specification* and review the options provided therein for specification requirements. Embedded specification notes also provide additional guidance. Square brackets are used in the sample specification to indicate optional text, alternatives, or where information is required to be entered from the writer.

Plant specifications are also established by the manufacturer and these govern production and installation except where project specifications are more demanding.

The specifier and designer should give particular attention to the following:

Precast anchors, supports and lifting hardware

The sample specification provides for hot dipped galvanizing of these components for all architectural precast panel types. This is proposed as the minimum required level of corrosion protection. Stainless steel hardware may also be used. The preference is for bolted connections as opposed to field welding, which can negatively affect the corrosion protection offered by the material.

Concrete mix design

The precast manufacturer is responsible for design of the concrete mix, which must be proportioned to meet the specified properties. The specified properties in the sample specification meet the prescriptive requirements of CSA-A23.1 and CSA-A23.4 based on exposure classification F-2 (concrete in an unsaturated condition exposed to freezing and thawing). This exposure classification is appropriate for exterior wall panels in areas not subjected to chlorides (deicing chemicals).

Manufacturing requirements, such as the need to often remove forms within 24 hours of casting, may govern the actual mix design, including the use of supplementary cementing materials and high early strength cement.

Selection of finishes

Manufacturing limitations of local precast plants and historical evidence of good long-term performance for the desired finish are important considerations for the designer. Manufacturing techniques and practices available should be reviewed. Consultation with the manufacturing plant in the preliminary design stages is recommended.

PART 1 - GENERAL

1.1 RELATED SECTIONS

- .1 Section 03300 – Cast-in-Place Concrete.
- .2 Section 05121 – Structural Steel (for Buildings).
- .3 Section 07212 – Board Insulation.
- .4 Section 07216 – Spray-in-Place Urethane Foam Insulation.
- .5 Section 07840 – Fire Stopping.
- .6 Section 07900 – Joint Sealers.
- .7 Section 08100 – Doors and Frames.
- .8 Section 08500 – Windows.

1.2 REFERENCES

- .1 Canadian General Standards Board (CGSB)
 - .1 CAN/CGSB-1.40-97, Anti-corrosive Structural Steel Alkyd.
 - .2 CAN/CGSB-1.181-92, Ready-Mixed Organic Zinc-Rich Coating.
- .2 Underwriters Laboratory Canada (ULC)
 - .1 CAN/ULC-S701-1997, Thermal Insulation, Polystyrene, Boards and Pipe Covering.
- .3 Canadian Standards Association (CSA)
 - .1 CSA-A23.1-00/A23.2-00, Concrete Materials and Methods of Concrete Construction / Methods of Test for Concrete.
 - .2 CSA-A23.3- 94, Design of Concrete Structures.
 - .3 CSA-A23.4-00, Precast Concrete-Materials and Construction.
 - .4 CSA-A23.5-98, Supplementary Cementing Materials.
 - .5 CSA A251-00, Qualification Code for Architectural and Structural Precast Concrete Products.
 - .6 CSA G30.5-M1983 (R1998), Welded Steel Wire Fabric for Concrete Reinforcement.
 - .7 CAN/CSA G30.18-M92 (R1998), Billet-Steel Bars for Concrete Reinforcement.

- .8 CSA-G40.21-98, Structural Quality Steels.
- .9 CAN/CSA G164-M92 (R1998), Hot Dip Galvanizing of Irregularly Shaped Articles.
- .10 CSA W47.1-92 (R1998), Certification of Companies for Fusion Welding of Steel Structures.
- .11 CSA W48.1-M1991 (R1998), Carbon Steel Covered Electrodes for Shielded Metal Arc Welding.
- .12 CSA W59-M1989 (R1998), Welded Steel Construction (Metal Arc Welding).
- .13 CSA W186-M1990 (R1998), Welding of Reinforcing Bars in Reinforced Concrete Construction.

1.3 DESIGN REQUIREMENTS

- .1 Design precast elements to CSA-A23.3, CSA-A23.4 and to resist handling, stockpiling, shipping and erection stresses.
- .2 Design precast elements to carry loads specified by Consultant or as indicated, in accordance with NBCC or governing provincial building code. Design shall include resistance to creep, shrinkage and temperature effects, as well as wind and earthquake loads.
- .3 Design connections/attachments of precast elements to load/forces specified by Consultant and to compensate for unevenness and dimensional differences in structure to which they are secured. Connections shall be designed to withstand long-term corrosion for exposed elements.
- .4 Tolerate structural deflection of span/360 due to live load and distortion of structure, under design criteria conditions, without imposing load on panel assembly.
- .5 Submit three copies of detailed calculations and design drawings for typical precast elements and connections for consultant for review three weeks prior to manufacture.

1.4 PERFORMANCE REQUIREMENTS

- .1 Tolerance of precast elements to CSA-A23.4, Section 10, except as noted herein.
- .2 Refer to related Sections of this Specification and fabricate work to accommodate specified tolerances.

1.5 SHOP DRAWINGS

- .1 Submit shop drawings in accordance with CSA-A23.4, CSA-A23.3, Section 01330 – Submittal Procedures (not included in this guide), and requirements of this Section.
- .2 Submit fully detailed and dimensioned shop drawings. Include the following items:
 - .1 Design calculations for items designed by manufacturer.
 - .2 Tables and bending diagrams of reinforcing steel.
 - .3 Finishing schedules.
 - .4 Methods of handling and erection.
 - .5 Openings, sleeves, inserts and related reinforcement, including embedded handling hardware.
- .3 Consult reviewed shop drawings relating to interface elements and show exact location of inserts and anchors required to be cast in precast units for interface elements.
- .4 Provide shop drawings to, and obtain approvals from, the Authorities having jurisdiction prior to fabrication.
- .5 Each drawing submitted shall bear stamp and signature of qualified professional engineer registered or licensed in province of [], Canada.

1.6 SAMPLES

- .1 Submit samples in accordance with Section 01330 – Submittal Procedures (not included in this guide). Unless otherwise noted, minimum size 300 x 300 x 25 mm. Finish exposed face as described under 2.4 Finishes of this Section. Make samples until final unconditional Consultant's approval is obtained. All work shall match approved production run samples.

- .2 Produce, deliver and erect where directed by Consultant on project site, full size precast concrete units incorporating required details and co-operate with work of adjoining trades to demonstrate range of finishes and required and building envelope systems.

1.7 QUALIFICATIONS

- .1 Precast concrete elements shall be fabricated and erected by a manufacturing plant certified by Canadian Standards Association according to CSA A251. Precast concrete manufacturer shall be certified prior to submitting tender and to specifically verify as part of tender that the plant is currently certified in Architectural Precast Concrete Products (designated category AC per CSA A251). Only precast elements fabricated in such certified plants shall be acceptable to owner, and plant certification shall be maintained for duration of fabrication, erection and until warranty expires.
- .2 The precast concrete manufacturer shall have a proven record and satisfactory experience in the design, manufacture and erection of architectural precast concrete of the type specified. The company shall have adequate financing, equipment, plant, and skilled personnel to detail, fabricate and erect the work of this Section. The size of the plant shall be adequate to maintain the required delivery schedule.

1.8 DELIVERY, STORAGE AND PROTECTION

- .1 Accept full responsibility for delivery, handling and storage of units.
- .2 Deliver, handle and store precast units [in a near vertical plane at all times], and by methods approved by the manufacturer. Do not permit units to contact earth or staining influences or to rest on corners. Do not stockpile defective units but remove from site.
- .3 Construct easels for stacking units and place non-staining spacers between each unit. If wood is used it shall be wrapped with polyethylene.
- .4 Protect holes and reglets from water and ice during freezing weather.

1.9 WASTE MANAGEMENT AND DISPOSAL

- .1 Separate and recycle waste materials in accordance with Section 01355 - Waste Management and Disposal and the Waste Reduction Workplan.
- .2 Ensure emptied containers are sealed and stored safely for disposal away from children.

- .3 Prevent plasticizers, water-reducing agents and air-entraining agents from entering drinking water supplies or streams. Using appropriate safety precautions, collect liquid or solidify liquid with an inert, noncombustible material and remove for disposal. Dispose of all waste in accordance with applicable local, provincial and national regulations.

1.10 WARRANTY

- .1 The Contractor hereby warrants that the precast architectural elements will not spall or show visible evidence of cracking, except for normal hairline shrinkage cracks, in accordance with GC12.3, for two years.
- .2 Warranty shall be in writing and shall warrant work under this Section to be free from defects for the period stipulated.

PART 2 - PRODUCTS

2.1 MATERIALS

- .1 Cement, colouring material, aggregates, water, admixtures: to CSA-A23.4 and CSA-A23.1. Supplementary cementing materials: to CSA-A23.5.
- .2 Exposed aggregate: to match selected finish sample.
- .3 Use same brands and source of cement and aggregate for entire project to ensure uniformity of colouration and other mix characteristics.
- .4 Reinforcing steel: to CSA-G30.18.
- .6 Welded wire fabric: to CSA-G30.5.
- .7 Forms: to CSA-A23.4.
- .8 Hardware and miscellaneous materials: to CSA-A23.4.
- .9 Anchors and supports: to CSA-G40.21, Type 300 W, galvanized after fabrication.

- .10 Welding materials: to CSA-W48.1.
- .11 Galvanizing: hot dipped galvanizing with minimum zinc coating of 610 g/m² to CAN/CSA-G164.
- .12 Steel primer: to CAN/CGSB-I.40.
- .13 Air entrainment admixtures: to CSA-A23.1.
- .14 Chemical Admixtures: to CSA-A23.1.
- .15 Zinc-rich primer: to CAN/CGSB-I.181.
- .16 Surface retarder: water based, low VOC, solvent free. Do not allow moisture of any kind to come in contact with the retarder film.
- .17 Insulation: extruded polystyrene to CAN/CGSB-51.20, Type 4.
- .18 Bearing pads: neoprene, 60 durometer hardness to ASTM D2240, and 17 MPa minimum tensile strength to ASTM D412, moulded to size or cut from moulded sheet.
- .19 Shims: plastic or steel.
- .18 Curing compound: not permitted without prior approval of Consultant.

2.2 CONCRETE MIXES

- .1 Proportion normal density concrete in accordance with CSA-A23.4, Alternative 1, to give following properties:
 - .1 Cement: use Type 10 [Type 30] Portland cement. Use white or grey cement in facing matrix.
 - .2 Minimum compressive strength at 28 days: 30 MPa.
 - .3 Class of exposure: F-2.
 - .5 Nominal size of coarse aggregate: 12 mm.
 - .6 Maximum water/cementing material ratio: 0.50.
 - .7 Air content: 4 to 7%.
- .2 Use of calcium chloride is not permitted.

2.3 MANUFACTURE

- .1 Manufacture units in accordance with CSA-A23.4.
- .2 Mark each precast unit to correspond to identification mark on shop drawings for location with date cast on part of unit which will not be exposed.
- .3 Design and attach anchors and inserts to precast concrete elements to carry design loads.
- .4 Galvanize anchors and steel embedments after fabrication and touch up with zinc-rich primer after welding.
- .5 Ensure that surfaces to receive sealant are smooth and free of laitance to provide a suitable base for adhesion. Ensure that release agents do not deleteriously affect the sealing of the joints.
- .6 Cast panels face down in accurate rigid forms designed to withstand high-frequency vibration. Set reinforcing anchors and auxiliary items as detailed. Cast in anchors, blocking and inserts supplied by other Sections as required to accommodate their work. Vibrate concrete continuously during casting until full thickness is reached. Provide necessary holes and sinkages for flashings, anchors, cramps, etc. as indicated and/or required. Separately and accurately batch cement and aggregates uniformly by weight to ensure maintenance of even and uniform appearance.
- .7 Anchors, lifting hooks, shear bars, spacers and other inserts or fittings required shall be as recommended and/or designed by manufacturer for a complete and rigid installation. Lift hooks shall be adequately sized to safely handle panels according to panel dimension and weight. Anchors/inserts shall be concealed where practical.
- .8 Burn off lift cables, paint and fill in where required if unit is damaged due to burn off.

2.4 FINISHES

- .1 Finish and color of precast units to match sample in Consultant's office.
- .2 Fluted finish: achieve finish using grooved form liners.
- .3 Smooth finish: a cast using smooth steel form liners.

- .4 Rubbed finish:
 - .1 Rub exposed face surface of precast concrete panels with carborundum bricks and water until hollows, lines, form marks and surplus materials have been removed.
 - .2 Leave surface finish uniformly smooth.
 - .3 Do not use mortar or grout in rubbing, other than cement paste drawn from green concrete by rubbing process.
 - .4 Clean panels.
- .5 Exposed aggregate finish:
 - .1 Apply uniform coat of retardant to inside face of forms.
 - .2 Expose coarse aggregate by washing and brushing away surface mortar.
 - .3 Expose aggregate to conform with approved samples which can be viewed at job site.
- .6 Sand-embedded aggregate finish:
 - .1 Hand place large facing aggregate on silica sand bed spread over form bottom.
 - .2 Remove panels from forms after concrete hardens.
 - .3 Expose aggregate by breaking away loose sand.
- .7 Sandblasted finish: in order to expose aggregate face, sandblast surface to conform with approved samples which can be viewed at job site.
- .8 Smooth float back surface of precast units exposed on both sides.

2.5 SOURCE QUALITY CONTROL

- .1 Provide Consultant with certified copies of quality control tests related to this project as specified in CSA-A23.4 and CSA-A251.
- .2 Provide Consultant with records from in-house quality control programme based upon plant certification requirements to for inspection and review.
- .3 Upon request, provide Consultant with certified copy of mill test report of reinforcing steel supplied, showing physical and chemical analysis.
- .4 Precast plants shall keep complete records of supply source of concrete material, steel reinforcement, prestressing steel and provide them to Consultant for review upon request.

PART 3 - EXECUTION

3.1 GENERAL

- .1 Do precast concrete work in accordance with CSA-A23.4 and CSA-A23.3.
- .2 Supply anchors for precast units required to be cast into the concrete frame to the General Contractor for installation. Provide such items in ample time to meet construction program. Supply layout drawings as per locating accurately the position of all cast-in items to be installed by other Sections.
- .3 Provide and install sufficient temporary bracing to brace precast units adequately, at all stages of construction, so that units will safely withstand loads to which they may be subjected. This temporary bracing shall remain in position until all connections have been completed.

3.2 ERECTION

- .1 Erect precast elements straight, level and square within allowable tolerances as specified.
- .2 Non-cumulative erection tolerances in accordance with CSA-A23.4, Section 10.
- .3 Set elevations and alignment between units to within allowable tolerances before connecting units.
- .4 Grout underside of unit bearing plates where indicated with shrinkage compensating grout.
- .5 Fasten precast panels in place as indicated on reviewed shop drawings.
- .6 Secure bolts with lockwashers, tack-weld nut to bolt, or damage bolt thread.

- .7 Uniformly tighten bolted connections with torque indicated.
- .8 Do not weld or secure bearing plates at sliding joints.
- .9 Set units dry, without mortar, attaining specified joint dimension with steel shims.
- .10 Clean field welds with wire brush and touch-up galvanized finish with zinc-rich primer.
- .11 Remove shims and spacers from joints of non-load bearing panels after fastening but before sealant is applied.
- .12 Apply sealant to joints in precast panels to Section 07900 – Joint Sealers (not included in this guide).

3.3 WELDING

- .1 Do welding in accordance with CSA-W59 for welding to steel structures and CSA-W186 for welding of reinforcement.

3.4 CLEANING

- .1 Obtain approval of cleaning methods from Consultant before cleaning soiled precast concrete surfaces.

End of Section

6

CHAPTER SIX

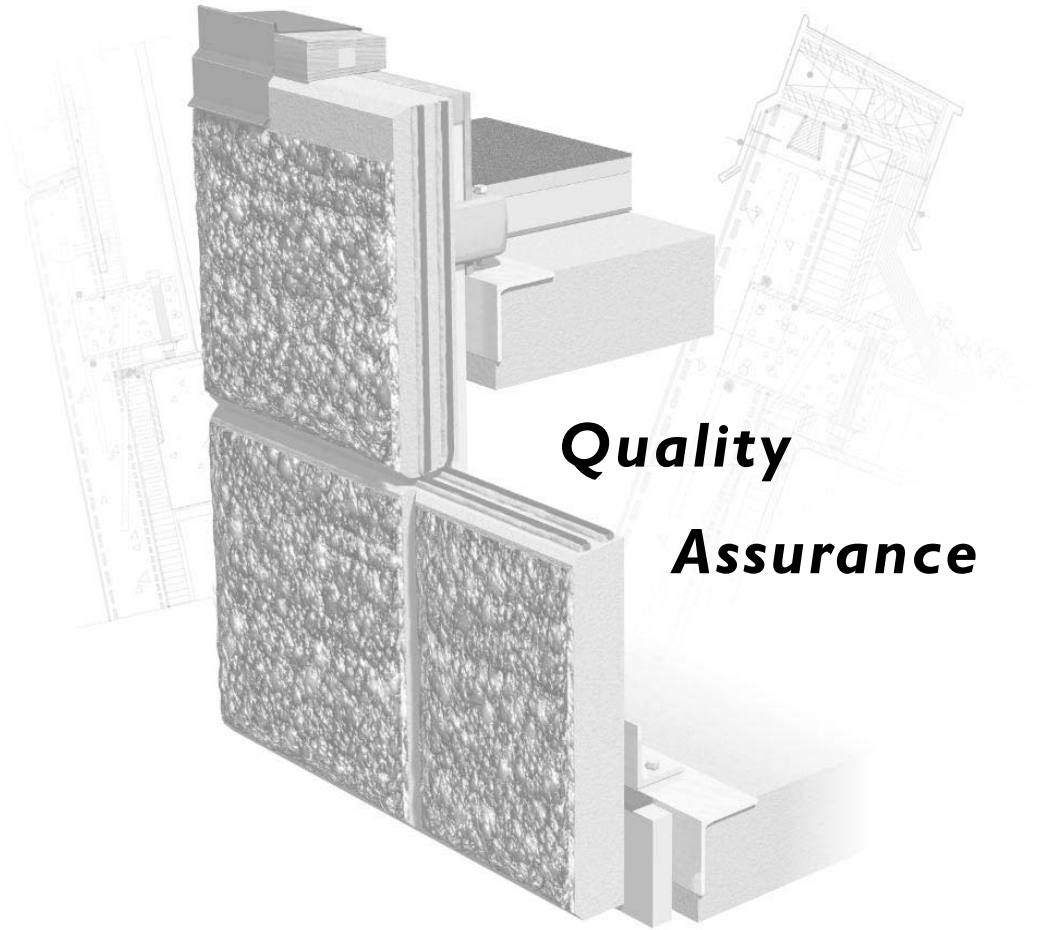

***Quality
Assurance***

OVERVIEW

Quality assurance is defined as the process to ensure that the constructed building envelope meets all of the performance requirements. The process includes quality control measures as well as systematic application of fundamental project quality control initiatives by all parties (including the owner, design team and general and trade contractors).

Quality control measures include provision of construction review to determine general compliance to the design and contract documents, and material specific testing or sampling to confirm compliance to prescriptive or performance requirements of the design. Proper coordination of trades, sequencing of work, review of shop drawings, and effective communication between parties are examples of fundamental quality control initiatives that are required for the overall success of the project.

Materials to be used and methods to be followed for the manufacture, transport and erection of architectural precast concrete (when manufacturing is done in a plant) is governed by CSA standard A23.4-00 – "Precast Concrete – Materials and Construction". This standard specifies construction tolerances for wall panels (including main panel dimensions and joints between panels), procedures for fabrication and placement of reinforcement and hardware, concrete cover to reinforcement, concrete quality and procedures for placement, curing and finishing. The designer and specifier should become familiar with this standard especially with regards to items that directly impact on the design such as manufacturing tolerances.

Manufacturing plants must be certified by the Canadian Standards Association according to CSA Standard A251-00 – "Qualification Code for Architectural and Structural Precast Concrete Products". This standard covers requirements for the physical production facilities, services and equipment, storage of materials, batching and mixing, form and mould fabrication, production, curing and laboratory facilities. Plant engineering, shop drawing production, plant standards, transportation, handling, storage and erection are also governed by this standard as well as quality control measures including testing, inspection and record keeping.

The National Building Code of Canada requires plant certification to CSA-A251. Certification to this standard implies a level of quality control in the manufacturing/production of the precast that is consistent with the requirements of the standard.

THE SHOP DRAWING REVIEW PROCESS

Preparation of shop drawings certified by a qualified professional engineer is the responsibility of the manufacturing plant. Requirements for the shop drawings are specified in CSA-A251. They include general arrangement drawings, erection drawings, setting drawings showing the location of site embedded hardware, and production drawings for individual elements for plant production.

The prime consultant, typically the project Architect, is responsible for review of shop drawing submissions and coordination with the design team. The General Contractor is responsible for coordination with the various trades.

A key element in the shop drawing review process is to ensure proper coordination of the work of other trades particularly at interfaces between the precast panels and other construction. The location and detail of the precast anchors to the structural frame of the building should be reviewed and details developed to maintain the integrity of the building envelope at these locations.

Window shop drawings should be reviewed in conjunction with review of the precast shop drawings. Responsibility for continuity or connection of the air barrier, thermal insulation and vapour barrier between the precast and adjacent construction should be defined on the project drawings and coordinated between the trades at the time of shop drawing review. Reviewed shop drawings should be copied to all trades affected by the work.

IMPLEMENTATION OF DESIGN

Plant visits should be carried out by the prime consultant during the production of the precast panels to observe methods and materials employed in the fabrication. The prime consultant should request a copy of the written quality control procedures established by the manufacturing plant. Documentation of material test results, either established by plant tests of raw materials or based on certified test reports from suppliers, should be submitted from the plant to the prime consultant on a regular basis throughout the production period.

Post-pour inspection of the finished product should also be conducted to identify faults or defects in the product prior to shipping to the job site. The reader is directed to Clause 6 of CSA-A251 for further information regarding submission of quality control data to the prime consultant.

A full scale mock-up of the exterior wall construction is recommended at commencement of precast erection operations. The mock-up should include all main elements of the exterior wall as well as the connection between elements. The mock-up should include details representative of all key elements in the project, including anchorage to the structural frame of the building. This may require that two or three mock-ups be constructed, such as one each at the roof, ground and intermediate slab levels.

Clarifications to the design details should be formalized by issuing supplementary details as site instructions or bulletins. Changes to the design details should similarly be documented and issued to all parties. It is critical that variances from the design, including dimensional relationships between elements within the exterior wall assembly, and details (and materials) for connection and continuity of the building envelope, be worked out at the mock-up stage and prior to proceeding with construction of the exterior wall.

The prime consultant should accept overall responsibility for the review of mock-ups but the building envelope and structural consultants also play key roles in this review and problem resolution. The general and trades-contractors should also contribute to this process.

Periodic field review to confirm general compliance to the contract documents and to the accepted mock-up construction is required through to project completion to ensure that the quality established by the accepted mock-up is maintained. Field measurement of as-built joint dimensions should also be conducted especially at locations where adequate width is required to accommodate creep and shrinkage (of the building frame) due to sustained loads.

Ongoing coordination between the design team and the various trades must be continued through to project completion to ensure that all parties receive notice of any changes or revisions that may affect related work.

7

CHAPTER SEVEN

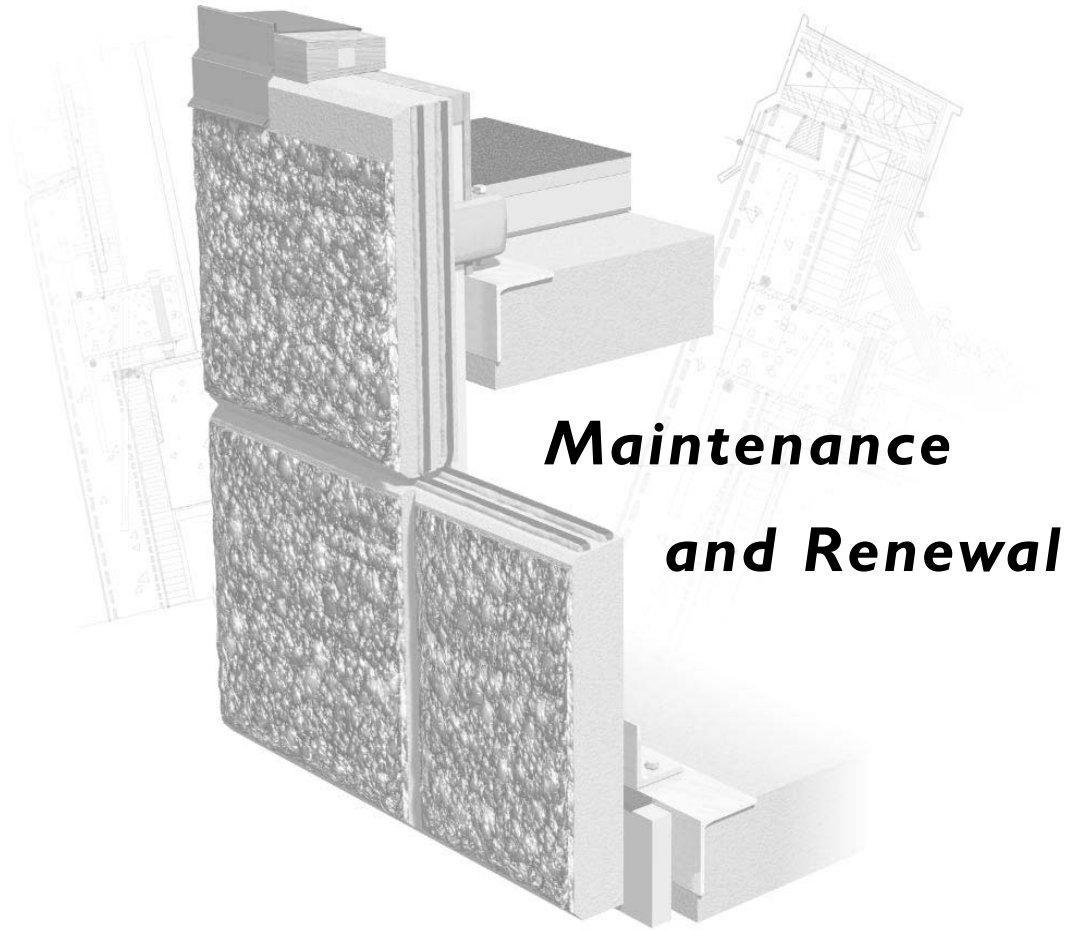

Maintenance and Renewal

OVERVIEW

An important consideration in the design and selection of building envelope materials is the life cycle cost of the system. Precast concrete is a system of choice for buildings of importance and higher quality construction. There is an expectation of durability in these buildings, which are often used for institutional facilities such as government offices, hospitals, universities and corporate offices.

Along with the higher quality of building and expected long life of the facility is an operational requirement to maintain and renew parts of the building façade over the service life of the building. Precast concrete panels, by the nature of their size and mass, and integral connection to the building structure, are not easily removed and replaced. It is therefore imperative that they be designed and constructed as durable elements and for easy on-site repair and maintenance.

MAINTENANCE PLANNING

During the design and selection of architectural precast panels, consideration is required for details that address issues such as access to the exterior face, water run off and dirt marking, re-glazing or replacement of windows, re-caulking of joints, and exterior cleaning. Other factors are selection of durable aggregate and concrete mix designs with low absorption and permeability characteristics. These are important especially in Canadian climates where wetting and freeze-thaw conditions are prevalent.

RENEWAL PLANNING

Good quality concrete is an inherent characteristic of architectural precast and the life of the precast panels is considered equal to the life of the structure. Exceptions to this can arise if severe exposure to adverse environments or poor design lead to accelerated weathering. Renewal planning for architectural precast normally involves the replacement of the joint sealant between the panels and between the concrete and other adjoining materials. Experience has shown that a good quality sealant in a properly designed joint can have a service life of 20 years. Some cosmetic concrete repairs are normally required because of physical damage from swing stages. Detailing exterior reveals and edges to avoid ridges and thin projections can reduce the potential for this type of damage.

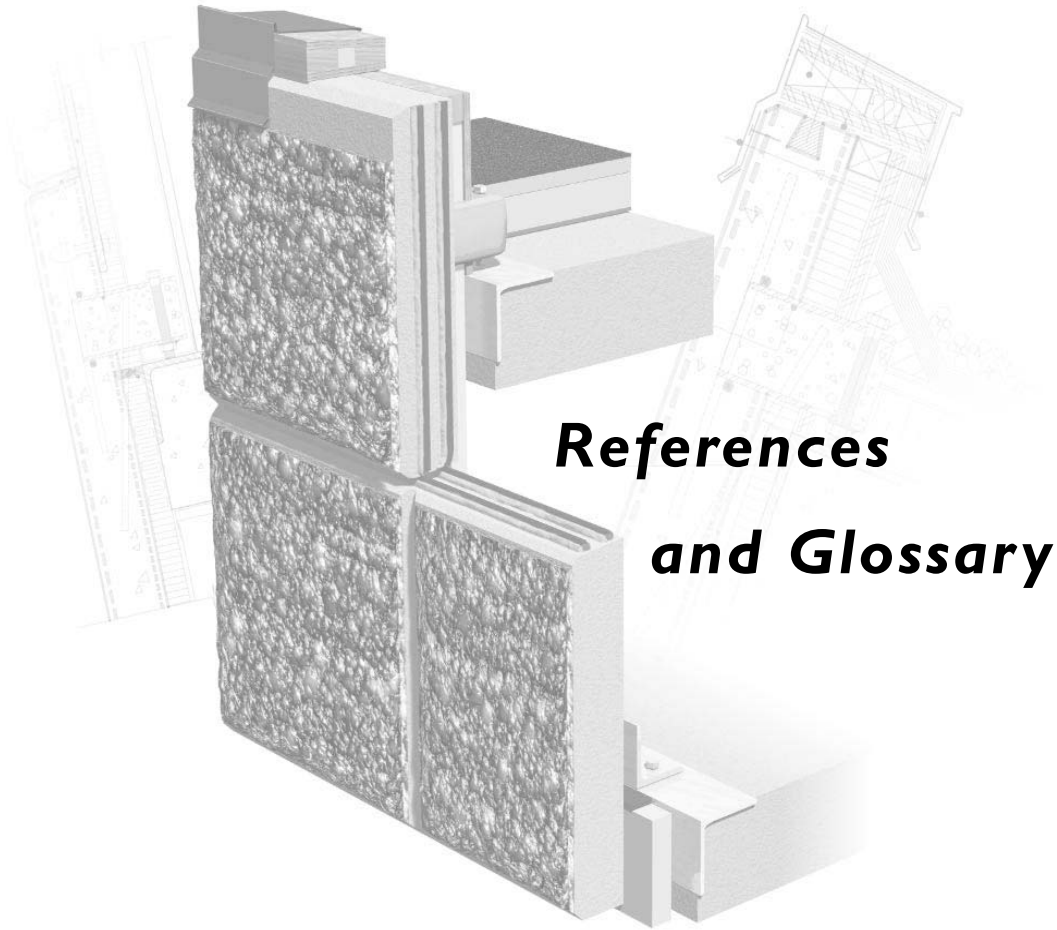

**References
and Glossary**

REFERENCES

- Architectural Precast Concrete*. Second edition. Precast/Prestressed Concrete Institute. 1989.
- Architectural Precast Concrete – Technical Brochure*. Canadian Precast/Prestressed Concrete Institute.
- Design Manual, Precast and Prestressed Concrete*. Third edition. Canadian Precast/Prestressed Concrete Institute. 1996.
- Garden, G.K. *Rain penetration and its control*. Canadian Building Digest No. 40. National Research Council of Canada. April 1963.
- Garden, G.K. *Control of air leakage is important*. Canadian Building Digest No. 72. National Research Council of Canada. December 1965.
- Garden, G.K. *Use of sealants*. Canadian Building Digest No. 96. National Research Council of Canada. December 1967.
- Garden, G.K. *Look at joint performance*. Canadian Building Digest No. 97. National Research Council of Canada. January 1968.
- Gustaferro, A.H. and M.S. Abrams. *Fire tests of joints between precast wall panels: Effect of various joint treatments*. PCI Journal, Vol. 20, No. 5. Sept.-Oct. 1975.
- Handegord, G.O. and K.K. Karpati. *Joint movement and sealant selection*. Canadian Building Digest No. 155. National Research Council of Canada. 1973.
- Handbook of Fundamentals*. American Society of Heating, Refrigerating, and Air-Conditioning Engineers. 1997.
- Hutcheon, N.B. *Requirements for exterior walls*. Canadian Building Digest No. 48. National Research Council of Canada. December 1963.
- Latta, J.K. *Precast concrete walls – problems with conventional design*. Canadian Building Digest No. 93. National Research Council of Canada. September 1967.
- Latta, J.K. *Precast concrete walls – a new basis for design*. Canadian Building Digest No. 94. National Research Council of Canada. October 1967.
- National Building Code of Canada. Canadian Commission on Building and Fire Codes. National Research Council of Canada. 1995.
- Plewes, W.G. *Cladding problems due to frame movement*. Canadian Building Digest No. 125. National Research Council of Canada. May 1970.
- Road and railway noise*. Metric edition. Canada Mortgage and Housing Corporation. 1978.
- Road and railway noise: Effects on housing*. Metric edition. Canada Mortgage and Housing Corporation. 1977.

GLOSSARY

A number of the terms that are used in the *Best Practice Guide* have specific meaning in the context of this Guide and are therefore defined below:

- Air barrier system** the assembly installed (in the building envelope) to provide a continuous barrier to the movement of air (NBC'95)

- Architectural precast** precast concrete units which, through finish, shape, colour and texture, define the architectural aesthetic and function of the structure (*CPCI Design Manual – Precast and Prestressed Concrete*)

- Vapour barrier** the elements installed (in the building envelope) to control the diffusion of water vapour (NBC'95)